



# Gedik Welding

*since 1963...*

## GENERAL PRODUCT CATALOGUE



Welding Consumables



Repair & Maintenance and Special Welding Products



Welding & Cutting Machines



Robotic Welding & Automation Systems



Please read the QR code to see our products in our mobile applications.

[www.gedikwelding.com](http://www.gedikwelding.com)

## COMPANY PROFILE

GEDİK WELDING was established in Turkey in 1963 and is today a global industry leader in the field of welding consumables and equipments. Under its internationally-registered trademarks GeKa and GeKaTec, the company manufactures about 90,000 tons/year of superior quality coated welding electrodes, brazing rods, special repair and maintenance products, as well as gas-shielded arc, submerged arc and flux-cored arc welding wires. The company also produces its own GeKaMac brand of rectifiers, gas shielded arc and submerged arc welding generators (conventional and inverter types)

GEDİK WELDING is one of the largest manufacturers in Europe and exports its products to more than 80 countries around the world. Keeping abreast of the largest technological developments in the domain, GEDİK WELDING also develops produce robotic solutions and welding automation equipment (GeKa Robot) for various industries, both in Turkey and overseas.



# Gedik Welding

Able and willing to serve all industrial sectors, GEDİK WELDING is fully prepared to explore alternative solutions in order to satisfy its customers. The company is therefore able to supply customized welding products and innovative engineering solutions, tailor-made to respond to the diverse needs of its clientele.

Continuous efforts are also undertaken to expand and improve its wide of range of multi-sector products and services, relying on its own in-house know-how and technology. The company's R&D efforts are managed by expert teams at its modern laboratory facilities in Istanbul, where cutting-edge, durable, relevant and economical solutions and products are constantly being generated.

GEDİK WELDING also contributes to the advancement of welding science and technology via R&D projects carried out in collaboration with İSTANBUL GEDİK UNIVERSITY. Further, the non-profit organisation, Gedik Educational Foundation (GEV), conducts various internationally-recognised welding education, training and certification programmes.



For more information, please visit our website; [www.gedikwelding.com](http://www.gedikwelding.com)



## Product Categories

 Welding Electrodes

---

 Gas Shielded Arc Welding Wires

---

 Flux Cored Arc Welding Wires

---

 Submerged Arc Welding Wires & Fluxes

---

 Repair & Maintenance Products

---

 Brazing Rods & Fluxes

---

 Welding & Cutting Machines

---

## Our Registered Trademarks

 **GeKa** Welding Consumables

---

 **GeKaTec** Repair & Maintenance and Special Welding Products

---

 **GeKaMac** Welding & Cutting Machines

---

 **GeKaRobotics** Robotic Welding & Automation Systems

---

Product Name	TS / EN	AWS	Page
<b>Rutile Electrodes</b>			<b>GeKa</b>
ELIT	E 42 0 RR 12	E 6013	1
PANTERA	E 42 0 RR 12	E 6013	2
LOTUS	E 42 0 RC 11	E 6013	3
EGE	E 38 0 RC 12	E 6013	4
GRANIT	E 38 2 RB 12	~E 6013	5
STEP	E 42 0 RC 11	E 6012	6
INTER	E 38 0 RC 11	E 6013	7
ELIT ARMCO	E 35 A RR 12	---	8
ELIT R 110	E 42 0 RR 33	E 7014	9
CEM	E 42 0 RR 53	E 7024	10
<b>Cellulosic Electrodes</b>			<b>GeKa</b>
LINK 6010	E 38 3 C 21	E 6010	11
LINK 7010-G	E 42 2 Mo C 21	E 7010-G	12
LINK 7010-P1	E 42 3 C 21	E 7010-P1	13
LINK 8010-G	E Z 46 3 Mo C 21	E 8010-G	14
LINK 8010-P1	E 46 3 1 Ni C 21	E 8010-P1	15
<b>Low Hydrogen Electrodes</b>			<b>GeKa</b>
LASER B 43	E 38 4 B 42 H5	E 7016-1 H4	16
LASER B 47	E 42 4 B 42 H5	E 7018 H4	17
LASER B 47-A	E 42 4 B 32 H5	E 7016-1 H4	18
LASER B 50	E 42 5 B 42 H5	E 7018-1 H4	19
LASER B 55	E 46 5 B 42 H5	E 7018-1 H4	20
LASER B 55-S	E 46 6 B 42 H5	E 7018-1 H4	21
LASER B 60	E 42 4 B 42 H5	E 7018 H4	22
<b>Low Alloyed High Strength Electrodes</b>			<b>GeKa</b>
TEMPO B 48	E 42 6 1 Ni B 32 H5	E 7018-G H4	23
TEMPO B 60	E 46 6 1 Ni B 42 H5	E 8018-G H4	24
TEMPO B 63	E 50 3 B 42 H5	E 8018-G H4	25
TEMPO B 65	E 55 6 1 NiMo B 42 H5	E 8018-G H4	26
TEMPO B 70 M	E 55 6 Z(NiMo) B 42 H5	E 9018 MH4	27
TEMPO B 70 S	E 55 6 2NiMo B T 42 H5	E 9018-G H4	28
TEMPO B 70 Mo	E 55 5 MnMo B 42 H5	~E 9018-D1 H4	29
TEMPO B 75	E 62 6 Z 1NiMo B 42 H5	E 10018-G H4	30
TEMPO B 85 M	E 69 5 Mn 2 NiCrMo B 42 H5	E 11018-M H4	31
TEMPO B 90	E 69 5 Z Mn2NiCrMo B 42 H5	E 12018-G H4	32
TEMPO Ni Cu	E 42 3 Z (NiCrCu) B 42 H5	E 7018-G/7018-W1 (mod.)H4	33
TEMPO B W2	E 46 6 Z (NiCrCu) B 42 H5	E 8018-W2 H4	34
TEMPO B 1	E 46 6 1 Ni B 42 H5	E 8018-C3 H4	35
TEMPO B 2	E 46 6 2 Ni B 42 H5	E 8018-C1 H4	36
TEMPO B 3	E 46 6 3 Ni B 42 H5	E 8018-C2 H4	37

Product Name	TS / EN	AWS	Page
<b>Heat Resisting Electrodes</b>			<b>GeKa</b>
OPUS MOR	E Mo R 12	---	38
OPUS MOB	E Mo B 42 H5	E 7018-A1 H4	39
OPUS C	E Cr Mo 1 R 12	E 8013-G	40
OPUS CM	E Cr Mo 1 B 42 H5	E 8018-B2 H4	41
OPUS CM-15	E Cr Mo 1 B 42 H5	E 8015-B2 H4	42
OPUS CML	E Cr Mo 1 L B 42 H5	E 7018-B2 L H4	43
OPUS CMV	E Mo V B 42 H5	E 9018-G H4	44
OPUS 2 CM	E Cr Mo 2 B 42 H5	E 9018-B3 H4	45
OPUS 2 CM-15	E Cr Mo 2 B 42 H5	E 9015-B3 H4	46
OPUS 2 CML	E Cr Mo 2 L B 42 H5	E 8018-B3 L H4	47
OPUS 5 CM	E Cr Mo 5 B 42 H5	E 8018-B6 (E502-15) H4	48
OPUS 9 CM	E Cr Mo 9 B 42 H5	E 8018-B8(E505-15) H4	49
OPUS 9 CM-15	E Cr Mo 9 B 42 H5	E 8015 B8 H4	50
OPUS 9 CMV	E Cr Mo 91 B 42 H5	E 9018-B91 H4	51
OPUS 9 CMV-15	E Cr Mo 91 B 42 H5	E 9015-B91 H4	52
OPUS P92	---	E 9018-B92 (mod.)	53
<b>Stainless Steel Electrodes</b>			<b>GeKa</b>
ELOX B 307	E 18 8 Mn B 22	~E 307-15	54
ELOX R 307	E 18 8 Mn R 32	~E 307-16	55
ELOX B 307 L	E 18 9 Mn Mo B 22	E 307-15	56
ELOX RS 307	E Z 18 9 Mn Mo R 53	~E 307-26	57
ELOX R 308 L	E 19 9 LR 32	E 308 L-16	58
ELOX R 308 L-17	E 19 9 LR 32	E 308 L-17	59
ELOX R 308 H	E 19 9 H R 22	E 308 H-16	60
ELOX B 308 L	E 19 9 LB 22	E 308 L-15	61
ELOX B 308 H	E 19 9 HB 22	E 308 H-15	62
ELOX R 308 L Mo	ES 308 LMo-16	E 308 LMo-16	63
ELOX RS 308	E 19 9 R 53	E 308-26	64
ELOX R 309 L	E 23 12 LR 32	E 309 L-16	65
ELOX R 309 H	ES 309-16	E 309 H-16	66
ELOX R 309 L-17	E 23 12 LR 32	E 309 L-17	67
ELOX R 309 MoL	E 23 12 2 LR 32	E 309 L Mo-16	68
ELOX R 309 MoL-17	E 23 12 2 LR 32	E 309 L Mo-17	69
ELOX B 309	E 22 12 B 22	E 309-15	70
ELOX R 310	E 25 20 R 32	~E 310-16	71
ELOX R 310 Mo	ES 310 Mo-16	E 310 Mo-16	72
ELOX B 310	E 25 20 B 22	~E 310-15	73
ELOX R 312	E 29 9 R 12	~E 312-16	74
ELOX R 316 L	E 19 12 3 LR 32	E 316 L-16	75
ELOX R 316 L-17	E 19 12 3 LR 32	E 316 L-17	76
ELOX B 316 L	E 19 12 3 LB 22	E 316 L-15	77
ELOX RS 316	E 19 12 2 R 53	E 316-26	78
ELOX R 317 L	E Z 19 13 4 LR 12	E 317 L-16	79
ELOX R 318	E 19 12 3 Nb R 32	~E 318-16	80
ELOX B 318	E 19 12 3 Nb B 22	E 318-15	81
ELOX B 327	E 25 4 B 22	---	82

Product Name	TS / EN	AWS	Page
<b>Stainless Steel Electrodes</b>			<b>GeKa</b>
ELOX R 347	E 19 9 Nb R 32	E 347-16	83
ELOX B 347	E 19 9 Nb B 22	E 347-15	84
ELOX R 385	E Z 20 25 5 Cu LNR 32	E 385-16	85
ELOX B 385	E Z 20 25 5 Cu NL B 22	E 385-15	86
ELOX B 410	E 13 B 22	E 410-15	87
ELOX B 410 Ni Mo	E 13 4 B 42	E 410 NiMo-15	88
ELOX BS 410 Ni Mo	E 13 4 B 62	E 410 NiMo-25	89
ELOX B 430	E 17 B 22	E 430-15	90
ELOX B 430 Mo	E Z 17 Mo B 22	---	91
ELOX R 2209	E 22 9 3 N LR 32	E 2209-17	92
ELOX B 2209	E 22 9 3 N LB 22	E 2209-15	93
ELOX B 2594	E 25 9 4 N L B 42	E 2594-15	94
ELOX B 16-8-2	E Z 16 8 2 B 22	E 16 8 2-15	95
<b>Cast Iron Electrodes</b>			<b>GeKa</b>
ELNIKEL	E C Ni-Cl 1	E Ni-Cl	96
ELNIKEL-HD	E C Ni-Cl 3	E Ni-Cl	97
ELNIKEL-NC	E C Ni-Cl 1	E Ni-Cl	98
ELNIFER	E C NiFe Cl 1	E NiFe-Cl	99
ELMONEL	E C NiCu-B1	~E NiCu B	100
ELFER	EC Fe-2	---	101
<b>Hardfacing Electrodes</b>			<b>GeKa</b>
ELHARD 250	E Fe 1	E 1-UM-250	102
ELHARD 300	E Fe 1	E 1-UM-300	103
ELHARD 300 R	E Fe 1	E 1-UM-300	104
ELHARD 350	E Fe 1	E 1-UM-350	105
ELHARD 400	E Fe 1	E 1-UM-400	106
ELHARD 500	E Z Fe 1	E 1-UM-50	107
ELHARD 600	E Fe 8	E 6-UM-60 P	108
ELHARD 600 S	E Fe 8	E 6-UM-60 P	109
ELHARD 600 R	E Fe 8	E 6-UM-60 P	110
ELHARD 650	E Fe 6	E 6-UM-60	111
ELHARD 650 Si	E Fe 2	E 2-UM-60	112
ELHARD 700	E Fe 2	~E6-UM-60	113
ELHARD 14 Mn	E Z Fe 9	E 7-UM-200K (E FeMn-A)	114
ELHARD 40 W	E Fe 1	E 3-UM-400GPTS	115
ELHARD 58	E Fe 4	~E 4-UM-60	116
ELHARD 60	E Fe 14	E 10-UM-60 GRZ	117
ELHARD 62	E Fe 16	~E 10-UM-60 GRZ	118
ELHARD 63	E Z Fe 14	E10-UM-60 GRZ (~E FeCr-A8)	119
ELHARD 65	E Fe 16	E 10-UM-65 GRZ	120

Product Name	TS / EN	AWS	Page
<b>Nickel Based Electrodes</b>			<b>GeKa</b>
NIBAZ B 65	E-Ni 6625 (NiCr22Mo9Nb)	E NiCrMo-3	121
NIBAZ B 70	E-Ni 6082 (NiCr20Mn3Nb)	~E NiCrFe 3	122
NIBAZ B 71	E-Ni 6182 (NiCr15Fe6Mn)	E NiCrFe 3	123
<b>Cutting &amp; Gouging Electrodes</b>			<b>GeKa</b>
ELIT CUT	-	-	124
ELIT NUT	-	-	124
<b>Gas Shielded Arc Welding Wires &amp; Rods</b>			<b>GeKa</b>
SG 1	G 2Si	ER 70 S-3	126
SG 70 S-2	G 2Ti	ER 70 S-2	127
SG 2	G 3Si1	ER 70 S-6	128
SG 3	G 4Si1	ER 70 S-6	129
<b>Heat Resisting Arc Welding Wires &amp; Rods</b>			<b>GeKa</b>
SG Mo	G Mo Si / W Mo Si	ER 80 S-G mod. (ER 70 S-A1)	130
SG 80 S-D2	G 4Mo / W 4Mo	ER 80 S-D2	131
SG CrMo 1	G Z Cr Mo 1 Si / W Z Cr Mo 1 Si G	ER 80 S-B2	132
SG CrMo 1 Si	Cr Mo 1 Si / W Cr Mo 1 Si	ER 80 S-G	133
SG CrMo 2	G Z Cr Mo 2 Si / W Z Cr Mo 2 Si G	ER 90 S-B3	134
SG CrMo 2 Si	Cr Mo 2 Si / W Cr Mo 2 Si	ER 90 S-G	135
SG CrMo 5	G / W Cr Mo 5 Si	ER 80 S-B6	136
SG CrMo 9V	W Cr Mo 91	ER 90 S-B9	137
<b>High Strength Arc Welding Wires &amp; Rods</b>			<b>GeKa</b>
SG Ni 1	G 3Ni1 / W 3Ni1	ER 80 S-Ni1	138
SG Ni 2	G 2Ni2	ER 80 S-Ni2	139
SG NiMo 1	G 62 6 C1/M21 Mn3Ni1Mo	ER 100 S-G	140
ER 100 SG	G/W Mn3Ni1CrMo	ER 100 S-G	141
ER 110 SG	G/W Mn4Ni2CrMo	ER 110 S-G	142
ER 120 SG	G 89 4 M21 Mn4Ni2,5CrMo	ER 120 S-G	143
<b>Weather Resistant Arc Welding Wires</b>			<b>GeKa</b>
SG NiCu	~G 3Ni1	ER 80S-G	144
<b>Stainless Steel Gas Shielded Welding Wires &amp; Rods</b>			<b>GeKa</b>
ELOX SG 307	G 18 8 Mn / W 18 8 Mn	~ER 307	145
ELOX SG 308 H	W 19 9 H	ER 308 H	146
ELOX SG 308 L	W 19 9 L	ER 308 L	147
ELOX SG 308 L Si	G 19 9 L Si	ER 308 L Si	148
ELOX SG 309 L	W 23 12 L	ER 309 L	149
ELOX SG 309 L Si	G 23 12 L Si	ER 309 L Si	150
ELOX SG 310	G 25 20 / W 25 20	ER 310	151
ELOX SG 312	G 29 9 / W 29 9	ER 312	152



Product Name	TS / EN	AWS	Page
<b>Stainless Steel Gas Shielded Welding Wires &amp; Rods</b>			<b>GeKa®</b>
ELOX SG 316 L	W Z 19 12 3 L	ER 316 L	153
ELOX SG 316 L Si	G Z 19 12 3 L Si	ER 316 L Si	154
ELOX SG 318	W 19 12 3 Nb	ER 318	155
ELOX SG 318 Si	G 19 12 3 Nb Si	~ER 318	156
ELOX SG 347	W 19 9 Nb	ER 347	157
ELOX SG 347 Si	G 19 9 Nb Si	ER 347 Si	158
ELOX SG 409 CB	---	ER 409 Nb	159
ELOX SG 410	G / W 13	ER 410	160
ELOX SG 430	G / W 17	ER 430	161
ELOX SG 2209	W 22 9 3 N L	ER 2209	162
ELOX SG 2594	W 25 9 4 N L	ER 2594	163
<b>Aluminium Alloyed Gas Shielded Welding Wires (MIG)</b>			<b>GeKa®</b>
AISI 5	S Al 4043 (AISI5)	ER 4043	164
Al 99.5	~S Al 1100 (Al99.0Cu)	~ER 1100	165
AlMg 3	S Al 5754 (AlMg3)	---	166
AlMg 5	S Al 5356 (AlMg5Cr(A))	ER 5356	167
AlMg 4.5 Mn	S Al 5183 (AlMg4.5Mn0.7A)	ER 5183	168
<b>Aluminium Alloyed Gas Shielded Welding Rods (TIG)</b>			<b>GeKa®</b>
AISI 5 TIG	S Al 4043 (AISI5) / Al 105	ER 4043	169
AISI 12 TIG	S Al 4047 (AISI12) / Al 112	ER 4047	170
Al 99.5 TIG	~SAI 1100 (Al99.0 Cu)	~ER 1100	171
AlMg 5 TIG	S Al 5356 (AlMg5Cr(A))	ER 5356	172
AlMg4.5Mn TIG	S Al 5183 (AlMg4.5Mn0.7A)	ER 5183	173
<b>Copper Alloyed Gas Shielded Welding Wires</b>			<b>GeKa®</b>
R1	S Cu 6560 (CuSi3Mn1)	ERCuSi-A	174
R1 L	~S Cu 1898 (CuSn1)	ER Cu	175
R1 AG	S Cu 1897 (CuAg1)	---	176
R4	S Cu 5410 (CuSn12P)	---	177
R4 L	S CuSn6 P - CF452K	~ER CuSn-A	178
R4 A	S Cu 6180 (CuAl10Fe)	ER CuAl - A2	179
R4 AL	S Cu 6100 (CuAl8)	CuAl-A1	180
R4 M	---	ER CuMnNiAl	181
<b>Copper Alloyed Gas Shielded Welding Rods</b>			<b>GeKa®</b>
CuNi SG	S Cu 7158 (CuNi30)	ER CuNi	182
CuNiFe SG	S Cu 7061 (CuNi10)	---	183
<b>Unalloyed &amp; Low Alloyed Flux Cored Arc Welding Wires</b>			<b>GeKa®</b>
ELCOR R 71	T 42 4 P C 1 H5	E 71 T-1C-J	184
ELCOR R 71 CM	T 46 2 P M 1	E71 T-1M	185
ELCOR R 71 SC	T 46 4 P C 1 H5/T 46 3 P M 1 H5	E 71 T-1C, -1M H4	186
ELCOR MR 70	T 42 4 R C 3 H 10	E 70 T-9C J H8	187

Product Name	TS / EN	AWS	Page
<b>Unalloyed &amp; Low Alloyed Flux Cored Arc Welding Wires</b>			<b>GeKa</b>
ELCOR B 70	T 42 4 B M 3 H5	E 70 T-5 M J	188
ELCOR B 70 SC	T 42 4 B C M 3 H5	E 70 T-5C/-5M H4	189
ELCOR B 70-ARM	T 42 AZ B M 3	E 70 T-5 M	190
ELCOR M 70	T 46 5 M M 3	E 70 C-6 M	191
ELCOR M 70 SC	T 46 6 M M 1 H5	E 70 C-6 M H4	192
ELCOR M 80 Ni	T 50 4 M M 3	E 80 C Ni 1	193
ELCOR R 81 Ni	T 46 4 1Ni P C 1	E 81 T1-Ni1 C	194
ELCOR R 81 Ni SC	T 46 4 1 Ni P C 1 H5/T 50 3 1 Ni P M 1 H5	E 81 T1-Ni1 C, Ni1 M H4	195
<b>Low Alloyed High Strength Flux Cored Arc Welding Wires</b>			<b>GeKa</b>
ELCOR R 91	T 62 4 Mn1.5Ni P C 1	E 91 T1 - K2CJ	196
ELCOR R 91 SC	T624Mn1.5NiPC1H5/T623Mn1.5NiPM1H5	E 91 T1 - K2C, K2M H4	197
ELCOR R 110	T 69 4 Mn 2.5 Ni P C 1	E 111 T1-GC	198
ELCOR R 100 SC	T694Mn2.5NiPC1H5/T693Mn2.5NiPM1H5	E 111 T1-GC, GM H4	199
ELCOR M Ni2 SC	T 55 6 Mn2 Ni M M 1 H5	E 80 C-Ni2 H4	200
ELCOR M NiMo1 SC	T 55 4 1 NiMo M M 3 H5	E 90C-K3M H4/E 91 T1-G	201
ELCOR M NiCrMo SC	T 69 6 Mn2NiCrMo M M 1 H5	E 110 C-K4 H4	202
<b>Weather Resistant Flux Cored Arc Welding Wires</b>			<b>GeKa</b>
ELCOR R 81 NiCu	T 46 3 Z P C 1	E 81 T1-W2 C	203
ELCOR R 81 NiCu SC	T 46 2 Z P C 1 H5/T 46 2 Z P M 1 H5	E 81 T1-G H4	204
<b>Heat Resistant Flux Cored Arc Welding Wires</b>			<b>GeKa</b>
ELCOR R Mo	T 46 2 Mo R C 2	E 81 T1 -A1C	205
ELCOR M Mo	T 46 2 Mo M M 1	E 81 T1-A1 M	206
ELCOR R Mo SC	T 46 2 Mo R C 2 H5	E 81 T1-A1C H4	207
ELCOR M Mo SC	T 46 2 Mo M M 1 H5	E 81 T1-A1/E 80 C-D2-H4	208
FC TIG-B2	W Z CrMo1Si	E 80 C-B2 (mod.)	209
ELCOR R CrMo1	T CrMo1 R C 2	E 81 T1-B 2 C	210
ELCOR M CrMo1 SC	T CrMo1 M M 1 H5	E 80 C-B2-H4	211
ELCOR R CrMo2	T CrMo2 R C 1/T CrMo2 R M 1	E 91 T1-B3 C/ B3 M	212
ELCOR B CrMo2 SC	T CrMo2 BM 3 H5/T CrMo2 BC 3 H5	E 80 T5-B3-H4	213
<b>Stainless Steel Flux Cored Arc Welding Wires</b>			<b>GeKa</b>
ELOXCOR S 307	T 18 8 Mn P M21/C1 1	E 307 T1-1/-4 (mod.)	214
ELOXCOR S 308 L	T 19 9 L P M21/C1 1	E 308 L T1-1/-4	215
ELOXCOR S 309 L	T 23 12 L P M21/C1 1	E 309 L T1-1/-4	216
ELOXCOR S 316 L	T Z 19 12 3 L P M21/C1 1	E 316 L T1-1/-4	217
ELOXCOR S 2209	T 22 9 3 N L P M21/C1 1	E 2209 T1-1/-4	218
<b>Submerged Flux Cored Arc Welding Wires</b>			<b>GeKa</b>
SUBCOR B 31 SC	---	F8A4-EC-1	219
SUBCOR B-1D 35 SC	---	E8A6-EC-1D	220
SUBCOR B 40 SC	---	F7A8-EC-G/ F7P8-EC-G	221
SUBCOR 41 NiMo-LH	---	~EC 410 NiMo	222
SUBCOR 41 NiMo-MH	---	~EC 410 NiMo	223
SUBCOR 430	T Fe 7	---	224

Product Name	TS / EN	AWS	Page
<b>Submerged Arc Welding Wires</b>			<b>GeKa®</b>
S1	S1	EL 12	225
S2	S2	EM 12	226
S2Si	S2Si	EM 12K	227
S2Mo	S2Mo	EA 2	228
S2Mo TiB	SZ	EA 2 TiB	229
S3Si	S3Si	EH 12K	230
S3Mo	S3Mo	EA 4	231
S3 TiB	SZ	E-G	232
S3Mo TiB	SZ	EA 2 TiB (mod.)	233
S3 NiMo1	S3Ni1Mo	E F3	234
S3 NiCrMo 2.5	S3Ni2.5CrMo	EM 4 (mod.)	235
STAINLESS	---	---	236
<b>Submerged Arc Welding Fluxes</b>			<b>GeKa®</b>
ELIFLUX BAR	SA AR 1 77 AC	F6AZ-EL12/F7AZ-EM12	237
ELIFLUX BAS	SA AB 1 67 AC	F7 A5-EM12 / F7A5-EM12K	238
ELIFLUX BBR-AG	SA AB 1 67 AC H5	F6AZ-EL12 / F7A0-EM12	239
		F7A0-EM12K	
ELIFLUX BFB	SA AB 1 68 AC H5	F6A2-EL12/F7A4-EM12	240
		F7A2-EM12K/F7A4-EH12K	
ELIFLUX PIPE	SA AB 1 78 AC H5	F7A4-EM12/F7A4-EA2-A4	241
		F8A4-EA4-A4	
ELIFLUX BAB-S	SA AB 1 68 AC H5	F7A4-EH12K/F7A4-EM12	242
		F7A4-EM12K/F8A4-EA2-A3/ F11A4-EM4(mod.)-M4	
ELIFLUX BFPP	SA AB 1 66 AC H5	F7A2-EM12/F7A2-EM12K	243
		F8A4-EA2-A2	
ELIFLUX BFPV	SA FB 1 66 AC H5	F7A2-EM12/F7A2-EM12K	244
		F8A4-EA2-A2/F8A5-EA4-A3 F11A8-EM4(mod)-M4	
ELIFLUX BFF	SA FB 1 65 DC H5	F7A4-EH12K/F7A4-EM12	245
		F7A4-EM12K/F8A4-EA2-A2 F9A4-EF3(mod)-F3 F11A8-EM4(mod)-M4	
ELIFLUX BMS	SA CS/MS 1 68 AC	F6A0-EM12/F6AZ-EL12	246
ELIFLUX BSS-A	SA FB 2 65 DC	---	247
ELIFLUX BSS-D	SA FB 2 65 DC	---	248
ELIFLUX BSS-F	SA FB 2 / SA FB 3	---	249
ELIFLUX 350	SA FB 2 C Cr H5	---	250
<b>Gas Welding Wires</b>			<b>GeKa®</b>
ELIGAS 1	O I	R 45	251
ELIGAS 2	O Z	R 60	252
ELIGAS 4	O IV	R 60-G	253

Product Name	TS / EN	AWS	Page
<b>Cutting &amp; Gouging Electrodes</b>			<b>GeKaTec</b>
GROOVE	---	---	255
AIR	---	---	255
<b>Cast Iron Electrodes</b>			<b>GeKaTec</b>
St-CAST	E C Z Fe 1	E St	256
Ni-CAST	E C Ni-CI 1	E Ni-CI	257
Ni-CAST BFNC	E C Ni-CI 1	E Ni-CI	258
Fe-CAST	E C NiFe-CI 1	E NiFe-CI	259
Fe-CAST HD	E C NiFe-CI 1	E NiFe-CI	260
<b>Steel Electrodes</b>			<b>GeKaTec</b>
ANTI-CRACK 7015	E Ni 6182(mod.)(NiCr15Fe6Mn)	~E NiCrFe-3	261
ANTI-CRACK B 90	---	~E NiCrFe-3	262
299 SUPER	E 29 9 R 12	~E 312-16	263
299 HD	E 29 9 R 52	~E 312-26	264
UNIBASE 660 HD	E Z 18 9 Mn Mo R 53	~E 307-26	265
410 HD	E Z 13 B 62	E 410-25(mod.)	266
<b>Hardfacing Electrodes</b>			<b>GeKaTec</b>
FAZER 300	E Fe 1	E 1-UM-300	267
FAZER 17 MnCr	E Fe 9	E 7-UM-250KP	268
KAVTAM	---	---	269
FAZER 55 HD	E Fe 7	E 6-UM-55 GRP	270
FAZER 63 HD	E Z Fe 14	~E FeCr-A8/E 10-UM-60 GRZ	271
FAZER 65 B	E Fe 16	E 10-UM-65 R	272
COBALT 21	E Co 1	E 20-UM-300-CKTL	273
COBALT 6	E Co 2	E CoCr A/E 20-UM-45 CTZ	274
COBALT 12	E Co 3	E CoCr B/E 20-UM-50 CTZ	275
COBALT 1	E Co 3	E CoCr C/E 20-UM-55 CTZ	276
THERMO DUR	E Z Fe 8	E 3-UM-50 GTZ	277
THERMO WELD	E Ni 2	~E 23-UM-250 CKPZ	278
THERMO ROLL	E Fe 7	5-UM-400	279
THERMO RESIST	E Z Fe 8	E 3-UM-40 PT	280
<b>Tool Steel Electrodes</b>			<b>GeKaTec</b>
TOOL 58 S	E Z Fe 8	E 3-UM-60 ST	281
TOOL 60	E Fe 4	E Fe 5-A/E 4-UM-60 S	282
TOOL 66-KLP	E Fe7	E 5-UM-400	283
<b>Non Ferrous Electrodes</b>			<b>GeKaTec</b>
Cu-WELD	---	E Cu	284
BRONZE	---	E CuSn-C	285
ALBRONZE	---	E CuAl-A2(E CuAl8)	286
ALUWELD-Si	EL-AISi 5	E 4043	287
ALUWELD 12 Si	EL-AISi 12	---	288
ALUWELD 99 Al	EL-Al 99.5	E 1100	289

Product Name	TS / EN	AWS	Page
<b>Nickel Alloyed Gas Shielded Arc Welding Wires &amp; Rods</b>			<b>GeKaTec</b>
Ni SG	---	ER - Ni 1	290
NiCu 30 SG	S Ni 4060 (NiCu30Mn3Ti)	ER NiCu 7	291
625 SG	S Ni 6625 (NiCr22Mo9Nb)	ER NiCrMo 3	292
7015 SG	S Ni 6082	ER NiCr-3	293
NiFe SG	S C NiFe-1	---	294
<b>Titanium Alloyed TIG Welding Rod</b>			<b>GeKaTec</b>
Ti SG	---	ER Ti 2	295
<b>Hardfacing Welding Wires &amp; Rods</b>			<b>GeKaTec</b>
250 G	---	MSG 1-GZ-250	296
350 G	---	MSG 5-GZ-350	297
500 G	S Fe 2	MSG / WSG 2-GZ-50	298
600 G	S Fe 8	MSG 6 6-GZ-60	299
TOOL 40 SG	---	MSG 3-GZ-40-PT/WSG 3-GZ-40-PT	300
TOOL 45 SG	---	MSG 3-GZ-50-ST/WSG 3-GZ-50-ST	301
TOOL 55 SG	---	MSG 3-GZ-55-T/WSG 3-GZ-55-T	302
TOOL 55 FC TIG	T Fe 8	TIG 6-GF-55-T	303
TOOL 60 FC TIG	T Fe 4	TIG 3-GF-60-T	304
TOOL 58 SG	---	MSG/WSG 3-GZ-60-T	305
TOOL 60 SG	---	WSG 4-60-S	306
<b>Cobalt Based TIG Welding Rods</b>			<b>GeKaTec</b>
COBALT 6 TIG	---	ER Co Cr-A	307
COBALT 12 TIG	---	ER Co Cr-B	307
COBALT 1 TIG	---	ER Co Cr-C	307
<b>Tungsten Electrodes</b>			<b>GeKaTec</b>
TUNGSTEN Red	WTh 20	EWTh-2	309
TUNGSTEN Green	WP	EWP	309
TUNGSTEN Gold	WLa 15	EWLa-1.5	309
TUNGSTEN Blue	WLa 20	EWLa-2	309
TUNGSTEN Grey	WCe 20	EWCe-2	309
<b>Flux Cored Wire for Hardfacing</b>			<b>GeKaTec</b>
HARDCOR 300 G	T Fe 1	MF 1-GF-300 P	310
HARDCOR 300 O	T Fe 1	MF 1-GF-300 P	311
HARDCOR 41 NiMo G	T Fe 7	MF 5-45-PRT	312
HARDCOR 414	T Fe 7/T 13 4 M M 3	E C 410 NiMo (mod.)	313
HARDCOR 600 G	T Fe 6	MF 6-GF-60-GP	314
HARDCOR M 600 G	---	MF 6-GF-60-GP	315
HARDCOR 600 GS	T Fe 6	MF 6-GF-60-GR	316
HARDCOR 600 O	T Fe 8	MF 6-GF-60-GP	317
HARDCOR 660 O	T Fe 9	~MF 7-GF-200 KP	318
HARDCOR 14 Mn G	T Fe 9	MF 7-GF-200-KP	319

Product Name	TS / EN	AWS	Page
<b>Flux Cored Wire for Hardfacing</b>			<b>GeKaTec</b>
HARDCOR 14 Mn O	T Fe 9	MF 7-GF-250-KNP	320
HARDCOR 50 G	T Z Fe 8	MF 3-50-CKTZW	321
HARDCOR 55 O	T Fe 15	MF 10-GF-55-G	322
HARDCOR M 55	T Fe 8	MF 6-GF-55-GT	323
HARDCOR 58 TIC O	T Fe 8	MF 10-GF-60-GP	324
HARDCOR 63 O	T Fe 15	MF 10-GF-60-G	325
HARDCOR 63 OB	T Fe 15	MF 10-GF-65-G	326
HARDCOR 65 O	T Fe 16	MF 10-GF-65-GT	327
HARDCOR M 67	T Z Fe 16	MF 10-GF-65-G	328
<b>Cobalt Based Flux Cored Wire for Hardfacing</b>			<b>GeKaTec</b>
HARDCOR COBALT 1	T Co 3	MF 20-55-CTZ	329
HARDCOR COBALT 6	T Co 2	MF 20-45-CTZ	330
HARDCOR COBALT 12	T Co 3	MF 20-50-CTZ	331
<b>Welding &amp; Brazing Rods</b>			<b>GeKaTec</b>
S1 L	Cu 511	ER Cu	332
S2	Cu 681	---	333
S21	Cu 470	---	334
S3	~Cu 773	---	335
S4 L	Cu 922	ER CuSn-A	336
S4 AL	~Cu 565	~ER Cu Al-A1	337
S5	Cu P 180	B Cu P-2	338
L-Ag2P	Cu P 279	---	339
L-Ag5P	Cu P 281	B-Cu P3	340
L-Ag15P	Cu P 284	B Cu P-5	341
L-Ag20	B-Cu 40 ZnAgCd(~AG309)	---	342
L-Ag20 FC	B-Cu 40 ZnAgCd(~AG 309)	---	343
L-Ag30	Ag 330	---	344
L-Ag30 FC	Ag 330	---	345
L-Ag40	Ag 340	---	346
L-Ag40 FC	Ag 340	---	347
L-Ag55	Ag 155	---	348
L-Ag55 FC	Ag 155	---	349
<b>Welding &amp; Brazing Fluxes</b>			<b>GeKaTec</b>
F-SH1	FH 10	---	350
F-LH1	---	---	350
Packaging Information			351-355

<b>Product Name</b>	<b>Page</b>
<b>MMA</b>	
	<b>GeKaMac®</b>
PoWer ARC 165	359
PoWer ARC 200 LT	360
PoWer ARC 250	361
PoWer ARC 2800	362
PoWer ARC 420	363
RKM 350	364
RKM 450	365
RKM 650	366
RKM 800	367
RRM 500	368
<b>TIG</b>	
	<b>GeKaMac®</b>
PoWer TIG 170 DC	369
PoWer TIG 202 DC Pulse	370
PoWer TIG 2200 DC Pulse	371
PoWer TIG 2600 DC Pulse	372
PoWer TIG 300 DC Pulse	373
PoWer TIG 3000 DC Pulse	374
PoWer TIG 420 DC Pulse	375
PoWer TIG WB 500 DC Pulse	376
PoWer TIG 2200 AC / DC Pulse	377
PoWer TIG 300 AC / DC Pulse	378
PoWer TIG 3000 AC / DC Pulse	379
PoWer TIG 4000 AC / DC Pulse	380
PoWer TIG 500 AC / DC Pulse	381
<b>MIG / MAG</b>	
	<b>GeKaMac®</b>
PoWer MIG 1800 Synergic	382
PoWer MIG GS 380 S	383
PoWer MIG GS WB 400	384
PoWer MIG GS WB 400 L	385
PoWer MIG GS WB 500	386
PoWer MIG 2000 Pulse	387
PoWer MIG 255 Pulse	388
PoWer MIG GPS 270 C	389
PoWerTech 325 Pulse	390
PoWerTech 405 Pulse	391
PoWerTech 4000 / 5000 Vision Pulse	392
PoWer MIG GPS WB 320	393
PoWer MIG GPS WB 400	394
PoWer MIG GPS WB 400 AC / DC	395
PoWer MIG GPS WB 500L	396
GKM 240	397
GKM 250	398

<b>Product Name</b>	<b>Page</b>
<b>MIG / MAG</b>	<b>GeKaMac</b>
GKM 350-G	399
GKM 350-2G	400
GKM 420-G	401
GKM 420-W	402
GKM 420-2G	403
GKM 420-2W	404
GKM 500-2G	405
GKM 500-2W	406
GKM 600-2W	407
<b>PLASMA</b>	<b>GeKaMac</b>
PoWer CUT 45	408
PoWer CUT 61i	409
PoWer CUT 105	410
PoWer CUT 155	411
<b>SAW</b>	<b>GeKaMac</b>
PoWer SAW 1000	412
PoWer SAW 1250	413
<b>WELDING ACCESSORIES</b>	<b>GeKa</b>
Accessories	414-420
Technical Information	421-492



# WELDING ELECTRODES



WELDING ELECTRODES  
KAYNAK ELEKTROTLARI



**Geka**

*Joining. For life.  
Birləşdirir. Həyat üçün.*

WELDING ELECTRODES  
KAYNAK ELEKTROTLARI



**Geka**

*Joining. For life.  
Birləşdirir. Həyat üçün.*



small text on the side of the stack



**Geka**  
WELDING ELECTRODES  
KAYNAK ELEKTROTLARI

*Joining. For life.  
Birləşdirir. Həyat üçün.*



**Geka** WELDING ELECTRODES  
KAYNAK ELEKTROTLARI

SCHWEIßELEKTRODEN  
ELECTRODES EMBOGGES  
ELECTRODI PER SALDATURA  
ELECTRODES PARA SOLDAR  
СВАРОЧНЫЕ ЭЛЕКТРОДЫ  
القطب للحام



**Standards**

TS EN ISO 2560-A	: E 42 0 RR 12
EN ISO 2560-A	: E 42 0 RR 12
AWS A5.1	: E 6013

**Chemical Composition of Weld Metal % (Typical)**

C	Si	Mn
0.07	0.3	0.5

**Mechanical Properties**

Yield Strength (N/mm <sup>2</sup> )	Tensile Strength (N/mm <sup>2</sup> )	Impact Strength (ISO-V/0°C)	Elongation (L <sub>0</sub> =5d <sub>0</sub> ) (%)
min. 420	510-610	min. 47 J	min.22

**Typical Base Material Grades**

- S 235JR, S275JR, S235J2G3-S355J2G3, P235 GH, P265 GH, P255NH, P235T1-P355T1, P235T2-P355T2, P235G1TH, P255G1TH, L210-L360NB, S235JRS1-S235J2S1, S235JRS2 - S235J2S2

**Features and Applications**

- The mostly-used type among the rutile electrodes
- Electrode coating of high thickness
- Spatter and fume formation in low amounts
- Good welding beads
- Easy striking

**Welding Positions**

**Current Type**

D.C.(-) / A.C.

**Operating Data**

Product Code	Diameter x Length (mm) / (inch)		Welding Current (A)	Weight g / 100 pcs
3010100003	2.00 x 300	5/64 x 12"	45 - 80	1160
3010100012	2.50 x 350	3/32 x 14"	60 - 110	2000
3010100018	3.20 x 350	1/8 x 14"	100 - 140	3220
3010100024	4.00 x 350	5/32 x 14"	140 - 180	4740
3010100027	4.00 x 450	5/32 x 18"	140 - 180	6220
3010100030	5.00 x 350	3/16 x 14"	170- 240	7640
3010100033	5.00 x 450	3/16 x 18"	170 - 240	9680

**Approvals:** TSE, CE, TL, DNV-GL, BV, ABS, LR, NK, RINA, TÜV, DB, GOST-R, SEPRO, RCB

**Standards**

TS EN ISO 2560-A	: E 42 0 RR 12
EN ISO 2560-A	: E 42 0 RR 12
AWS A5.1	: E 6013

**Chemical Composition of Weld Metal % (Typical)**

C	Si	Mn
0.08	0.4	0.5

**Mechanical Properties**

Yield Strength (N/mm <sup>2</sup> )	Tensile Strength (N/mm <sup>2</sup> )	Impact Strength (ISO-V/0°C)	Elongation (L <sub>0</sub> =5d <sub>0</sub> ) (%)
min. 420	510-610	min. 47 J	min.22

**Typical Base Material Grades**

- S 235JR, S275JR, S235J2G3-S355J2G3, P235 GH, P265 GH, P255NH, P235T1-P355T1, P235T2-P355T2, P235G1TH, P255G1TH, L210-L360NB, S235JRS1-S235J2S1, S235JRS2-S235J2S2

**Features and Applications**

- Resistance to high current
- Soft and stable welding
- Spatter and fume formations in low amounts
- Formation of self-removable slags

**Welding Positions**

**Current Type**

D.C.(-) / A.C.

**Operating Data**

Product Code	Diameter x Length (mm) / (inch)		Welding Current (A)	Weight g / 100 pcs
3010100045	2.50 x 350	3/32 x 14"	60 - 110	2120
3010100048	3.20 x 350	1/8 x 14"	90 - 150	3370
3010100054	4.00 x 350	5/32 x 14"	130- 200	5130
3010100057	4.00 x 450	5/32 x 18"	130- 200	6660
3010100060	5.00 x 350	3/16 x 14"	170 - 250	8090
3010100063	5.00 x 450	3/16 x 18"	170 - 250	10410

**Approvals:** TSE, CE, TL, DNV-GL, BV, ABS, LR, GOST-R, SEPRO

**Standards**

TS EN ISO 2560-A	: E 42 0 RC 11
EN ISO 2560-A	: E 42 0 RC 11
AWS A5.1	: E 6013

**Chemical Composition of  
Weld Metal % (Typical)**

C	Si	Mn
0.07	0.3	0.4

**Mechanical Properties**

Yield Strength (N/mm <sup>2</sup> )	Tensile Strength (N/mm <sup>2</sup> )	Impact Strength (ISO-V/0°C)	Elongation (L <sub>0</sub> =5d <sub>0</sub> ) (%)
min. 420	510-610	min. 47 J	min.22

**Typical Base Material Grades**

- S 235JR, S275JR, S235J2G3-S355J2G3, P235 GH, P265 GH, P255NH, P235T1-P355T1, P235T2-P355T2, P235G1TH, P255G1TH, L210-L360NB, S235JRS1-S235J2S1, S235JRS2-S235J2S2

**Features and Applications**

- Electrode coating of medium-thickness
- Electrode coating of flexible type, providing electrode bendability
- Usability in welding of materials at hardly-reachable places
- Suitability for welding at vertical-down welding position

**Welding Positions**

**Current Type**

D.C.(-) / A.C.

**Operating Data**

Product Code	Diameter x Length (mm) / (inch)		Welding Current (A)	Weight g / 100 pcs
3010100072	2.50 x 350	3/32 x 14"	60-110	1760
3010100075	3.20 x 350	1/8 x 14"	90-140	2920
3010100081	4.00 x 350	5/32 x 14"	130-200	4290
3010100084	4.00 x 450	5/32 x 18"	130-200	5510
3010100087	5.00 x 350	3/16 x 14"	170-240	6955
3010100090	5.00 x 450	3/16 x 18"	170-250	8800

**Approvals:** TSE, CE, TL, LR, TÜV, DB, GOST-R, SEPRO

### Standards

TS EN ISO 2560-A	: E 38 0 RC 12
EN ISO 2560-A	: E 38 0 RC 12
AWS A5.1	: E 6013

### Chemical Composition of Weld Metal % (Typical)

C	Si	Mn
0.08	0.4	0.5

### Mechanical Properties

Yield Strength (N/mm <sup>2</sup> )	Tensile Strength (N/mm <sup>2</sup> )	Impact Strength (ISO-V/0°C)	Elongation (L <sub>0</sub> =5d <sub>0</sub> ) (%)
min. 380	470-550	min.47 J	min.22

### Typical Base Material Grades

- S 235JR, S275JR, S235J2G3-S355J2G3, P235 GH, P265 GH, P255NH, P235T1-P355T1, P235T2-P355T2, P235G1TH, P255G1TH, S235JRS1-S235J2S1, S235JRS2-S235J2S2

### Features and Applications

- Easily striking
- Suitability to spot welding
- Suitability for use in iron works

### Welding Positions



### Current Type

D.C.(-) / A.C.

### Operating Data

Product Code	Diameter x Length (mm) / (inch)		Welding Current (A)	Weight g / 100 pcs
3010100093	2.50 x 350	3/32 x 14"	60 - 110	1910
3010100096	3.20 x 350	1/8 x 14"	90 - 140	3160
3010100099	4.00 x 350	5/32 x 14"	130 - 180	4700

**Approvals:** TSE, CE, GOST-R, SEPRO

**Standards**

TS EN ISO 2560-A	: E 38 2 RB 12
EN ISO 2560-A	: E 38 2 RB 12
AWS A5.1	: ~ E 6013

**Chemical Composition of  
Weld Metal % (Typical)**

C	Si	Mn
0.08	0.2	0.5

**Mechanical Properties**

Yield Strength (N/mm <sup>2</sup> )	Tensile Strength (N/mm <sup>2</sup> )	Impact Strength (ISO-V/-20°C)	Elongation (L <sub>0</sub> =5d <sub>0</sub> ) (%)
min. 380	470-570	min.47 J	min.24

**Typical Base Material Grades**

- S 235JR, S275JR, S235J2G3-S355J2G3, P235 GH, P265 GH, P255NH, P235T1-P355T1, P235T2-P355T2, P235G1TH, P255G1TH, L210-L360NB, S235JRS1-S235J2S1, S235JRS2-S235J2S2

**Features and Applications**

- Electrode of rutile-basic character
- Electrode coating with high thickness
- Suitability for welding of pressure pipes
- Smooth welding bead without undercutting

**Welding Positions**

**Current Type**

D.C.(-) / A.C.

**Operating Data**

Product Code	Diameter x Length (mm) / (inch)		Welding Current (A)	Weight g / 100 pcs
3010100102	2.50 x 350	3/32 x 14"	60 - 110	1930
3010100105	3.20 x 350	1/8 x 14"	90 - 140	3315
3010100108	4.00 x 350	5/32 x 14"	110 - 200	4730

**Approvals:** TSE, CE, GOST-R, SEPRO



**Standards**

TS EN ISO 2560-A	: E 42 O RC 11
EN ISO 2560-A	: E 42 O RC 11
AWS A5.1	: E 6012

**Chemical Composition of  
Weld Metal % (Typical)**

C	Si	Mn
0.06	0.35	0.45

**Mechanical Properties**

Yield Strength (N/mm <sup>2</sup> )	Tensile Strength (N/mm <sup>2</sup> )	Impact Strength (ISO-V/0°C)	Elongation (L <sub>0</sub> =5d <sub>0</sub> ) (%)
min. 420	510-610	min.47 J	min.22

**Typical Base Material Grades**

- S 235JR, S275JR, S235J2G3-S355J2G3, P235 GH, P265 GH, P255NH, P235T1 - P355T1, P235T2-P355T2, P235G1TH, P255G1TH, L210-L360NB, S235JRS1-S235J2S1, S235JRS2-S235J2S2

**Features and Applications**

- Electrode coating with medium-thickness
- Electrode coating of flexible type, providing electrode bendability
- Usability in welding of materials at hardly-reachable places
- Suitability for welding at vertical down position

**Welding Positions**

**Current Type**

D.C.(-) / A.C.

**Operating Data**

Product Code	Diameter x Length (mm) / (inch)		Welding Current (A)	Weight g / 100 pcs
3010100120	2.50 x 350	3/32 x 14"	60 - 110	1730
3010100123	3.20 x 350	1/8 x 14"	90 - 140	2900
3010100126	4.00 x 350	5/32 x 14"	130 - 180	4275

**Approvals:** TSE, CE, GOST-R, SEPRO

**Standards**

TS EN ISO 2560-A	: E 38 0 RC 11
EN ISO 2560-A	: E 38 0 RC 11
AWS A5.1	: E 6013

**Chemical Composition of  
Weld Metal % (Typical)**

C	Si	Mn
0.06	0.3	0.5

**Mechanical Properties**

Yield Strength (N/mm <sup>2</sup> )	Tensile Strength (N/mm <sup>2</sup> )	Impact Strength (ISO-V/0°C)	Elongation (L <sub>0</sub> =5d <sub>0</sub> ) (%)
min.390	470-590	min.47 J	min.22

**Typical Base Material Grades**

- S 235JR, S275JR, S235J2G3-S355J2G3, P235 GH, P265 GH, P255NH, P235T1-P355T1, P235T2-P355T2, P235G1TH, P255G1TH, L210-L360NB, S235JRS1-S235J2S1, S235JRS2-S235J2S2

**Features and Applications**

- Electrode coating of flexible type, providing electrode bendability
- Suitability for welding at vertical-down position
- Deep penetration

**Welding Positions**

**Current Type**

D.C.(-) / A.C.

**Operating Data**

Product Code	Diameter x Length (mm) / (inch)		Welding Current (A)	Weight g / 100 pcs
3010100129	2.50 x 350	3/32 x 14"	60 - 110	1850
3010100132	3.20 x 350	1/8 x 14"	90 - 140	2940
3010100138	4.00 x 350	5/32 x 14"	110 - 180	4250
3010100141	4.00 x 450	5/32 x 18"	110 - 200	5460

**Approvals:** TSE, CE, GOST-R, SEPRO

**Standards**
**Chemical Composition of  
Weld Metal % (Typical)**

TS EN ISO 2560-A	: E 35 A RR 12
EN ISO 2560-A	: E 35 A RR 12

C	Si	Mn
0.05	max. 0.2	0.3

**Mechanical Properties**

Yield Strength (N/mm <sup>2</sup> )	Tensile Strength (N/mm <sup>2</sup> )	Impact Strength (ISO-V/+20°C)	Elongation (L <sub>0</sub> =5d <sub>0</sub> ) (%)
min. 355	440-560	min. 47 J	min. 22

**Features and Applications**

- Soft and stable welding
- Spatter formation in low amounts
- Formation of easily-removable slags
- Used for Armco Iron and very low carbon and silicon content steels, zinc bath containers used in galvanized coating

**Welding Positions**

**Current Type**

D.C.(-) / A.C.

**Operating Data**

Product Code	Diameter x Length (mm) / (inch)		Welding Current (A)	Weight g / 100 pcs
3010100150	3.20 x 350	1/8 x 14"	110 - 140	4090
3010100153	4.00 x 350	5/32 x 14"	140 - 180	6120
3010100156	5.00 x 350	3/16 x 14"	180 - 220	8160

**Approvals:** TSE, CE, GOST-R, SEPRO

**Standards**

TS EN ISO 2560-A	: E 42 0 RR 33
EN ISO 2560-A	: E 42 0 RR 33
AWS A5.1	: E 7014

**Chemical Composition of  
Weld Metal % (Typical)**

C	Si	Mn
0.07	0.4	0.6

**Mechanical Properties**

Yield Strength (N/mm <sup>2</sup> )	Tensile Strength (N/mm <sup>2</sup> )	Impact Strength (ISO-V/0°C)	Elongation (L <sub>0</sub> =5d <sub>0</sub> ) (%)
min. 420	520 - 600	min. 47 J	min. 22

**Typical Base Material Grades**

- S 235JR, S275JR, S235J2G3-S355J2G3, P235 GH, P265 GH, P255NH, S235JRS1-S235J2S1, S235JRS2-S235J2S2

**Features and Applications**

- Usability in welding at all positions
- Resistance to high current
- Soft and stable welding
- Spatter formation in low amounts
- Welding efficiency of about 110%

**Welding Positions**

**Current Type**

D.C.(-) / A.C.

**Operating Data**

Product Code	Diameter x Length (mm) / (inch)		Welding Current (A)	Weight g / 100 pcs
3010102195	3.20 x 350	1/8 x 14"	120 - 160	3558
3010102196	4.00 x 350	5/32 x 18"	150 - 220	5910

**Approvals:** TSE, CE, GOST-R, SEPRO, RCB

**Standards**

TS EN ISO 2560-A	: E 42 0 RR 53
EN ISO 2560-A	: E 42 0 RR 53
AWS A5.1	: E 7024

**Chemical Composition of Weld Metal % (Typical)**

C	Si	Mn
0.07	0.4	0.7

**Mechanical Properties**

Yield Strength (N/mm <sup>2</sup> )	Tensile Strength (N/mm <sup>2</sup> )	Impact Strength (ISO-V/0°C)	Elongation (L <sub>0</sub> =5d <sub>0</sub> ) (%)
min. 420	510 - 610	min. 47 J	min. 22

**Typical Base Material Grades**

- S 235JR, S275JR, S235J2G3-S355J2G3, P235GH, P265GH, P295GH, S235JRS1-S235J2S1, S235JRS2- S235J2S2,

**Features and Applications**

- Resistance to high current
- High welding efficiency (about 160%)
- Cost-saving in groove welding and in flat fillet welding

**Welding Positions**

**Current Type**

D.C.(-) / A.C.

**Operating Data**

Product Code	Diameter x Length (mm) / (inch)		Welding Current (A)	Weight g / 100 pcs
3010100171	3.20 x 350	1/8 x 14"	120 - 180	4710
3010100177	4.00 x 450	5/32 x 18"	160 - 240	9830
3010100180	5.00 x 450	3/16 x 18"	200 - 320	14950

**Approvals:** TSE, ABS, RS, RINA, NK, BV, CE, DNV-GL, GOST-R, SEPRO, RCB

**Standards**

TS EN ISO 2560-A	: E 38 3 C 21
EN ISO 2560-A	: E 38 3 C 21
AWS A5.1	: E 6010

**Chemical Composition of Weld Metal % (Typical)**

C	Si	Mn
0.12	0.2	0.6

**Mechanical Properties**

Yield Strength (N/mm <sup>2</sup> )	Tensile Strength (N/mm <sup>2</sup> )	Impact Strength (ISO-V/-30°C)	Elongation (Lo=5d <sub>0</sub> ) (%)
min.380	470-540	min.47 J	min.22

**Typical Base Material Grades**

- S235JR, S275JR, S235J2G3, S275J2G3, S355J2G3, P235GH, P265GH, P235T1-P355T1, P235T2-P355T2, L210-L360NB, L290MB-L360MB, S235JRS1-S235J2S2, P235G1TH, P255G1TH, X42-X56, for root pass X60-X80.

**Features and Applications**

- Suitability for use in welding large-diameter pipelines for crude oil, natural gas, and water as well as in root-pass welding or surfacing of ships, tanks, boilers, and steel constructions
- Usability in sour gas - involving applications (acc. HIC Test NACE TM-0284)
- Deep penetration obtained in welding at all positions
- Most suitability for welding at vertical down position

**Welding Positions**

**Current Type**

D.C.(+) / D.C. (-) for root pass

**Operating Data**

Product Code	Diameter x Length (mm) / (inch)		Welding Current (A)	Weight g / 100 pcs
3010100186	2.50 x 350	3/32 x 14"	40 - 80	1670
3010100189	3.20 x 350	1/8 x 14"	65 - 125	2720
3010100192	4.00 x 350	5/32 x 14"	90 - 175	4110
3010100195	5.00 x 350	3/16 x 14"	140-220	6210

**Approvals:** TSE, DNV-GL, TÜV, DB, CE, NACE, GOST-R, SEPRO

**Standards**

TS EN ISO 2560-A	: E 42 2 Mo C 21
EN ISO 2560-A	: E 42 2 Mo C 21
AWS A5.5	: E 7010 - G

**Chemical Composition of  
Weld Metal % (Typical)**

C	Si	Mn	Mo
0.10	0.15	0.4	0.3

**Mechanical Properties**

Yield Strength (N/mm <sup>2</sup> )	Tensile Strength (N/mm <sup>2</sup> )	Impact Strength (ISO-V/-20°C)	Elongation (L <sub>0</sub> =5d <sub>0</sub> ) (%)
min. 420	510 - 590	min. 47 J	min. 22

**Typical Base Material Grades**

- S235JR, S275JR, S235J2G3, S275J2G3, S355J2G3, P235GH, P265GH, P355T1, P235T2-P355T2, L210-L415NB, L290MB-L415MB, S235JRS1-S235J4S2, P235G1TH, P255G1TH, X42-X65 for root pass applications is using up to X70(L485MB)

**Features and Applications**

- It is used for root and filler passes in all welding positions of high strength steels, assembly pipelines, closed vessels and boilers, steel constructions
- Deep penetration, especially (obtained) at vertical-down position

**Welding Positions**

**Current Type**

D.C.(+)

**Operating Data**

Product Code	Diameter x Length (mm) / (inch)		Welding Current (A)	Weight g / 100 pcs
3010100234	2.50 x 350	3/32 x 14"	40 - 80	1700
3010100237	3.20 x 350	1/8 x 14"	65 - 125	2735
3010100240	4.00 x 350	5/32 x 14"	90 - 175	3990
3010100243	5.00 x 350	3/16 x 14"	140 - 220	6135

**Approvals:** TSE, CE, GOST-R, SEPRO

**Standards**

TS EN ISO 2560-A	: E 42 3 C 21
EN ISO 2560-A	: E 42 3 C 21
AWS A5.5	: E 7010-P1

**Chemical Composition of  
Weld Metal % (Typical)**

C	Si	Mn
0.15	0.2	1.0

**Mechanical Properties**

Yield Strength (N/mm <sup>2</sup> )	Tensile Strength (N/mm <sup>2</sup> )	Impact Strength (ISO-V/-30°C)	Elongation (L <sub>0</sub> =5d <sub>0</sub> ) (%)
min. 420	500-640	min. 47 J	min. 22

**Typical Base Material Grades**

- S235JR, S275JR, S235J2G3, S275J2G3, S355J2G3, P235GH, P265GH, P355T1, P235T2-P355T2, L210-L415NB, L290MB-L415MB, S235JRS1-S235J4S, P235G1TH, P255G1TH, X42-X60

**Features and Applications**

- Suitability for use in welding large-diameter high-strength steel pipelines and especially use in hot, filler and cap passes.
- Deep penetration, especially (obtained) at vertical-down position.
- For root-pass welding, GeKa electrode LINK 6010 is recommended.

**Welding Positions**

**Current Type**

D.C.(+)

**Operating Data**

Product Code	Diameter x Length (mm) / (inch)		Welding Current (A)	Weight g / 100 pcs
3010100253	2.50 x 350	3/32 x 14"	40 - 80	1700
3010100256	3.20 x 350	1/8 x 14"	65 - 125	2735
3010100259	4.00 x 350	5/32 x 14"	90 - 175	3990
3010100262	5.00 x 350	3/16 x 14"	140 - 220	6135

**Approvals:** TSE, CE, GOST-R, SEPRO



**Standards**

TS EN ISO 2560-A	: E Z 46 3 Mo C 21
EN ISO 2560-A	: E Z 46 3 Mo C 21
AWS A5.5	: E 8010 - G

**Chemical Composition of  
Weld Metal % (Typical)**

C	Si	Mn	Ni	Mo
0.14	0.2	0.9	0.2	0.15

**Mechanical Properties**

Yield Strength (N/mm <sup>2</sup> )	Tensile Strength (N/mm <sup>2</sup> )	Impact Strength (ISO-V/-30°C)	Elongation (L <sub>0</sub> =5d <sub>0</sub> ) (%)
min. 460	550 - 650	min. 47 J	min. 20

**Typical Base Material Grades**

- L290NB-L415NB, L290MB-L415MB, -L485MB, S235JRS1-S235J4S, X42-X70

**Features and Applications**

- Suitability for use in all-positions of welding high-strength low alloyed steel pipelines joining
- Suitability for use in welding all positions, particularly vertical down position
- Usability in sour gas - involving applications (acc. HIC Test NACE TM-0284)
- For root-pass welding, GeKa LINK 6010 is recommended

**Welding Positions**

**Current Type**

D.C.(+)

**Operating Data**

Product Code	Diameter x Length (mm) / (inch)		Welding Current (A)	Weight g / 100 pcs
3010100273	2.50 x 350	3/32 x 14"	40 - 80	1635
3010100276	3.20 x 350	1/8 x 14"	65 - 125	2640
3010100279	4.00 x 350	5/32 x 14"	90 - 175	4000
3010100282	5.00 x 350	3/16 x 14"	140 - 220	6340

**Approvals:** TSE, CE, GOST-R, NACE, SEPRO

**Standards**

TS EN ISO 2560-A	: E 46 3 1 Ni C 21
EN ISO 2560-A	: E 46 3 1 Ni C 21
AWS A5.5	: E 8010-P1

**Chemical Composition of  
Weld Metal % (Typical)**

C	Si	Mn	Ni
0.14	0.2	0.9	0.6

**Mechanical Properties**

Yield Strength (N/mm <sup>2</sup> )	Tensile Strength (N/mm <sup>2</sup> )	Impact Strength (ISO-V/-30°C)	Elongation (L <sub>0</sub> =5d <sub>0</sub> ) (%)
min. 460	550-650	min. 47 J	min. 20

**Typical Base Material Grades**

- L290NB-L415NB, L290MB-L415MB, -L485MB, S235JRS1-S235J4S, X42-X70

**Features and Applications**

- Suitability for use in all-positions of welding high-strength low alloyed steel pipelines joining
- Suitability for use in welding all positions, particularly vertical down position
- Can be used in sour gas applications
- For root-pass welding, GeKa LINK 6010 is recommended

**Welding Positions**

**Current Type**

D.C.(+)

**Operating Data**

Product Code	Diameter x Length (mm) / (inch)		Welding Current (A)	Weight g / 100 pcs
3010100305	2.50 x 350	3/32 x 14"	40 - 80	1635
3010100308	3.20 x 350	1/8 x 14"	65 - 125	2640
3010100311	4.00 x 350	5/32 x 14"	90 - 175	4000
3010100314	5.00 x 350	3/16 x 14"	140 - 220	6340

**Approvals:** BV, DNV-GL, CE, TSE, GOST-R, SEPRO

**Standards**

TS EN ISO 2560-A	: E 38 4 B 42 H5
EN ISO 2560-A	: E 38 4 B 42 H5
AWS A5.1	: E 7016-1 H4

**Chemical Composition of  
Weld Metal % (Typical)**

C	Si	Mn
0.06	0.5	0.7

**Mechanical Properties**

Yield Strength (N/mm <sup>2</sup> )	Tensile Strength (N/mm <sup>2</sup> )	Impact Strength (ISO-V/-50°C)	Elongation (L <sub>0</sub> =5d <sub>0</sub> ) (%)
min. 400	490-600	min. 47 J	min. 24

**Typical Base Material Grades**

- S235JR-E295, S235J2G3-S355J2G3, C22, C35, P235T1-P355T1, P235T2,P355T2, L210 -L320, L290MB-L320MB, P235G1TH, P255G1TH, P235GH,P265GH, P295GH, S235JRS1-S235J4S, S315G1S-S355G3S, S255N-S355N, P255NH-P355NH, S255NL-S355NL, GE200 - GE240
- API 5L: A, B, X42, X46, X52, X56

**Features and Applications**

- Suitability for use in welding at all positions except for vertical down position
- Weld metal recovery of about 110%
- Weld deposits with very low hydrogen content
- High-quality and ductile, crack-resistant weld metals, mostly forming rigid weldments with beads of large cross-sections
- D.C. (-) is recommended for the root pass
- Requirement of re-drying for minimum 2 hours at the temperatures between 300°C and 350°C

**Welding Positions**

**Current Type**

D.C. (-) for root pass / D.C. (+)

**Operating Data**

Product Code	Diameter x Length (mm) / (inch)		Welding Current (A)	Weight g / 100 pcs
3010100336	2.50 x 350	3/32 x 14"	80 -110	2270
3010100339	3.20 x 350	1/8 x 14"	100 - 140	3610
3010100342	4.00 x 450	5/32 x 18"	130 -190	6760
3010100345	5.00 x 450	3/16 x 18"	190 - 240	10125

**Approvals:** TSE, CE, GOST-R, ABS, SEPRO

**Standards**

TS EN ISO 2560-A	: E 42 4 B 42 H5
EN ISO 2560-A	: E 42 4 B 42 H5
AWS A5.1	: E 7018 H4

**Chemical Composition of  
Weld Metal % (Typical)**

C	Si	Mn
0.07	0.5	1.0

**Mechanical Properties**

Yield Strength (N/mm <sup>2</sup> )	Tensile Strength (N/mm <sup>2</sup> )	Impact Strength (ISO-V/-40°C)	Elongation (L <sub>0</sub> =5d <sub>0</sub> ) (%)
min. 420	510-600	min. 47 J	min. 24

**Typical Base Material Grades**

- S235JR-E295, E335, S235J2G3-S355J2G3, C22, C35, P235T1-P355T1, P235T2,P355T2, L210-L360, L290MB-L360MB, P235G1TH, P255G1TH, P235GH-P295GH, S235JRS1-S235J4S, S315G1S-S355G3S, S255N-S355N, P255NH-P355NH, S255NL-S355NL, GE200-GE300
- API 5L: A, B, X42, X46, X52, X56, X60

**Features and Applications**

- Suitability for use in out-of-position welding except for welding at vertical down position
- Excellent strength and toughness
- Suitability for use in the fields of steel constructions, boiler, container, machine manufacturing and shipbuilding as well as for use in welding low-purity and high-carbon steels
- Suitability for the formation of welding buffer layers when building up high-carbon steels
- Weld deposits with very low hydrogen content
- Weld metal recovery of about 120%
- Requirement of re-drying for minimum 2 hours at the temperatures between 300°C and 350°C

**Welding Positions**

**Current Type**

D.C. (+)

**Operating Data**

Product Code	Diameter x Length (mm) / (inch)		Welding Current (A)	Weight g / 100 pcs
3010100351	2.50 x 350	3/32 x 14"	80 - 110	2410
3010100354	3.20 x 350	1/8 x 14"	100 - 140	3790
3010100363	4.00 x 450	5/32 x 18"	130 - 190	6850
3010100369	5.00 x 450	3/16 x 18"	190 - 240	10715

**Approvals:** BV, DNV-GL, TL, DB, ABS, LR, RS, RINA, NK, TSE, TÜV, CE, GOST-R, SEPRO, RCB

**Standards**

TS EN ISO 2560-A	: E 42 4 B 32 H5
EN ISO 2560-A	: E 42 4 B 32 H5
AWS A5.1	: E 7016-1 H4

**Chemical Composition of  
Weld Metal % (Typical)**

C	Si	Mn
0.07	0.6	1.0

**Mechanical Properties**

Yield Strength (N/mm <sup>2</sup> )	Tensile Strength (N/mm <sup>2</sup> )	Impact Strength (ISO-V/-46°C)	Elongation (L <sub>0</sub> =5d <sub>0</sub> ) (%)
min. 420	500-610	min. 47 J	min. 24

**Typical Base Material Grades**

- S235JR-E295, E335, S235J2G3-S355J2G3, C22, C35, P235T1-P355T1, P235T2,P355T2, L210-L360, L290MB-L320MB, P235G1TH, P255G1TH, P235GH-P295GH, S235JRS1 S235J4S, S315G1S-S355G3S, S255N-S355N, GE200-GE300
- API 5L: A, B, X42, X46, X52, X56, X60

**Features and Applications**

- Suitability for welding with AC power
- Suitability for use in out-of-position welding except for welding at vertical down position
- Excellent strength and toughness
- Suitability for use in the fields of steel constructions, boiler, container, machine manufacturing, and shipbuilding construction as well as for use in welding low-purity and high-carbon steels
- Suitability for the formation of welding buffer layers when building up high-carbon steels
- Weld deposits with very low hydrogen content
- Weld metal recovery of about 125%
- Requirement of re drying for minimum 2 hours at the temperatures between 300°C and 350°C

**Welding Positions**

**Current Type**

D.C. (+) / A.C.

**Operating Data**

Product Code	Diameter x Length (mm) / (inch)		Welding Current (A)	Weight g / 100 pcs
3010100372	2.50 x 350	3/32 x 14"	80 -100	2320
3010100375	3.20 x 350	1/8 x 14"	100-140	3720
3010100378	4.00 x 350	5/32 x 14"	130 -190	5380
3010100381	4.00 x 450	5/32 x 18"	130 -190	6820

**Approvals:** TSE, CE, ABS, GOST-R, SEPRO

**Standards**

TS EN ISO 2560-A	: E 42 5 B 42 H5
EN ISO 2560-A	: E 42 5 B 42 H5
AWS A5.1	: E 7018 - 1 H4

**Chemical Composition of  
Weld Metal % (Typical)**

C	Si	Mn
0.08	0.5	1.1

**Mechanical Properties**

Yield Strength (N/mm <sup>2</sup> )	Tensile Strength (N/mm <sup>2</sup> )	Impact Strength (ISO-V/-50°C)	Elongation (L <sub>0</sub> =5d <sub>0</sub> ) (%)
min. 420	510-630	min. 47 J	min. 24

**Typical Base Material Grades**

- S235JR-E295, E335, S235J2G3-S355J2G3, C22, C35, P235T1-P355T1, P235T2,P355T2, L210-L360, L290MB-L360MB, P235G1TH, P255G1TH, P235GH-P355GH, S235JRS1-S235J4S, S315G1S-S355G3S, S255N-S355N, P255NH-P355NH, S255NL-S355NL, GE200-GE300
- API 5L: A, B, X42, X46, X52, X56, X60

**Features and Applications**

- Suitability for use in out-of-position welding except for welding at vertical down position
- Excellent strength and toughness
- Suitability for use in the fields of steel constructions, boiler, container, machine manufacturing and vertical construction as well as for use in welding low-purity and high-carbon steels
- Suitability for the formation of welding buffer layers when building up high-carbon steels
- Weld deposits with very low hydrogen content
- Weld metal recovery of about 110%
- Requirement of re-drying for minimum 2 hours at the emperatures between 300°C and 350°C

**Welding Positions**

**Current Type**

D.C.(+)

**Operating Data**

Product Code	Diameter x Length (mm) / (inch)		Welding Current (A)	Weight g / 100 pcs
3010100390	2.50 x 350	3/32 x 14"	80 -100	2220
3010100393	3.20 x 350	1/8 x 14"	100-140	3645
3010100402	4.00 x 450	5/32 x 18"	130 -190	6700
3010100408	5.00 x 450	3/16 x 18"	190/240	10500

**Product Code** TSE, ABS, CE, GOST-R, DNV-GL, SEPRO

**Standards**

TS EN ISO 2560-A	: E 46 5 B 42 H5
EN ISO 2560-A	: E 46 5 B 42 H5
AWS A5.1	: E 7018 - 1 H4

**Chemical Composition of  
Weld Metal % (Typical)**

C	Si	Mn
0.08	0.4	1.4

**Mechanical Properties**

Yield Strength (N/mm <sup>2</sup> )	Tensile Strength (N/mm <sup>2</sup> )	Impact Strength (ISO-V/-50°C)	Elongation (L <sub>0</sub> =5d <sub>0</sub> ) (%)
min. 460	530-650	min. 47 J	min. 24

**Typical Base Material Grades**

- S235JR-E295, E335, S235J2G3-S355J2G3, P235T1-P355T1, P235T2,P355T2, L210NB-L415NB, L290MB-L360MB, P235G1TH, P255G1TH, P235GH-P355GH, S235JRS1-S235J4S, S315G1 S-S355G3S, S255N-S380N, P255NH-P355NH, S255NL-S460NL1, GE200-GE300
- API 5L: X42, X46, X52, X56, X60, X65

**Features and Applications**

- Suitability for use in out-of-position welding except for welding at vertical down position
- High ductility at low temperatures down to -50°C
- Suitability for use in welding low-purity and high-carbon steels
- Weld deposits with very low hydrogen content
- High-quality weld metals with higher strength values
- Requirement of re-drying for minimum 2 hours at the temperatures between 300°C and 350°C

**Welding Positions**

**Current Type**

D.C. (+)

**Operating Data**

Product Code	Diameter x Length (mm) / (inch)		Welding Current (A)	Weight g / 100 pcs
3010100411	2.50 x 350	3/32 X 14"	80 - 100	2200
3010100414	3.20 x 350	1/8 X 14"	100 - 140	3550
3010100417	4.00 x 450	5/32 X 18"	130 -190	6570
3010100420	5.00 x 450	3/16 X 18"	190 - 240	10220

**Approvals:** TSE, CE, ABS, GOST-R, SEPRO

**Standards**

TS EN ISO 2560-A	: E 46 6 B 42 H5
EN ISO 2560-A	: E 46 6 B 42 H5
AWS A5.1	: E 7018 - 1 H4

**Chemical Composition of  
Weld Metal % (Typical)**

C	Si	Mn
0.08	0.4	1.4

**Mechanical Properties\***

Yield Strength (N/mm <sup>2</sup> )	Tensile Strength (N/mm <sup>2</sup> )	Impact Strength (ISO-V/-60°C)	Elongation (L <sub>0</sub> =5d <sub>0</sub> ) (%)
min. 460	530-650	min. 47 J	min. 24

\* CTOD tested

**Typical Base Material Grades**

- S235JR-E295, E335, S235J2G3-S355J2G3, P235T1-P355T1, P235T2,P355T2, L210NB-L415NB, L290MB-L360MB, P235G1TH, P255G1TH, P235GH-P355GH, S235JRS1-S235J4S, S315G1S-S355G3S, S255N-S380N, P255NH-P355NH, S255NL-S460NL1, GE200-GE300
- API 5L: X42, X46, X52, X56, X60, X65

**Features and Applications**

- Suitability for use in welding of high-strength, fine-grained steels
- High ductility at low temperatures down to -60°C
- It is used for joining thick materials safely
- Weld metal recovery of approx. 120%
- Requirement of re-drying for minimum 2 hours at the temperatures between 300°C and 350°C
- CTOD tested.

**Welding Positions**

**Current Type**

D.C.(+)

**Operating Data**

Product Code	Diameter x Length (mm) / (inch)		Welding Current (A)	Weight g / 100 pcs
3010100423	2.50 x 350	3/32 x 14"	80 - 100	2380
3010100426	3.20 x 350	1/8 x 14"	100 - 140	3740
3010100432	4.00 x 450	5/32 x 18"	130 - 190	7000

**Approvals:** TSE, BV, ABS, CE, GOST-R, SEPRO



**Standards**

TS EN ISO 2560-A	: E 42 4 B 42 H5
EN ISO 2560-A	: E 42 4 B 42 H5
AWS A5.1	: E 7018 - H4

**Chemical Composition of  
Weld Metal % (Typical)**

C	Si	Mn
0.08	0.6	1.2

**Mechanical Properties**

Yield Strength (N/mm <sup>2</sup> )	Tensile Strength (N/mm <sup>2</sup> )	Impact Strength (ISO-V/-40°C)	Elongation (L <sub>0</sub> =5d <sub>0</sub> ) (%)
min. 420	520-630	min. 47 J	min. 24

**Typical Base Material Grades**

- S235JR-E295, E335, S235J2G3-S355J2G3, C22, C35, P235T1-P355T1, P235T2,P355T2, L210-L360, L290MB-L360MB, P235G1TH, P255G1TH, P235GH-P355GH, S235JRS1-S235J4S, S315G1S-S355G3S, S255N-S355N, P255NH-P355NH, S255NL-S355NL, GE200-GE300
- API 5L: A, B, X42, X46, X52, X56, X60

**Features and Applications**

- Suitability for use in out-of-position welding except for welding at vertical down position
- Excellent strength and toughness
- Suitability for use in the fields of steel constructions, boiler, container, machine manufacturing and shipbuilding as well as for use in welding low purity and high-carbon steels
- The pressure vessels used in the production
- Suitability for the formation of welding buffer layers when building up high-carbon steels
- Weld deposits with very low hydrogen content
- Requirement of re-drying for minimum 2 hours at the temperatures between 300°C and 350°C

**Welding Positions**

**Current Type**

D.C. (+)

**Operating Data**

Product Code	Diameter x Length (mm) / (inch)		Welding Current (A)	Weight g / 100 pcs
3010100438	2.5 x 350	3/32 x 14"	60 - 90	2300
3010100441	3.2 x 350	1/8 x 14"	100 - 140	3700
3010100447	4.0 x 450	5/32 x 18"	150 - 210	6800
3010100450	5.0 x 450	3/16 x 18"	200 - 260	10200

**Approvals:** TSE, CE, GOST-R, SEPRO

**Standards**

TS EN ISO 2560-A	: E 42 6 1 Ni B 32 H5
EN ISO 2560-A	: E 42 6 1 Ni B 32 H5
AWS A5.5	: E 7018-G H4

**Chemical Composition of  
Weld Metal % (Typical)**

C	Si	Mn	Ni
0.06	0.5	1.0	0.8

**Mechanical Properties**

Yield Strength (N/mm <sup>2</sup> )	Tensile Strength (N/mm <sup>2</sup> )	Impact Strength (ISO-V/-60°C)	Elongation (L <sub>0</sub> =5d <sub>0</sub> ) (%)
min. 460	530-640	min. 47 J	min. 22

**Typical Base Material Grades**

- EN 10205: S355J2G3, S355JR, S355JO, S355J2G4, S355K2G3, S355K2G4, ASTM A 572 Gr.50, A709Gr.50, A678Gr.50, A633Gr.D
- API 5L: A, B, X42, X46, X52, X56, X60

**Features and Applications**

- This is AC/DC basic-coated electrode that has a weld metal recovery of 120% which can be used at all welding positions except for the vertical down position
- Usable with short arc in(-) pole for root pass welding with excellent penetration, especially at vertical-up position
- Weld deposit with high low temperature toughness
- Re-drying : 300-350°C / 2h

**Welding Positions**

**Current Type**

D.C.(+) / D.C.(-)  
A.C.

**Operating Data**

Product Code	Diameter x Length (mm) / (inch)		Welding Current (A)	Weight g / 100 pcs
3010100462	2.50 x 350	3/32 x 14"	60 - 100	2200
3010100465	3.20 x 350	1/8 x 14"	80 - 130	3680
3010100471	4.00 x 350	5/32 x 14"	120- 180	5370

**Approvals:** TSE, CE, ABS, GOST-R, SEPRO

**Standards**

TS EN ISO 2560-A	: E 46 6 1Ni B 42 H5
EN ISO 2560-A	: E 46 6 1Ni B 42 H5
AWS A5.5	: E 8018 - G H4

**Chemical Composition of  
Weld Metal % (Typical)**

C	Si	Mn	Ni
0.07	0.3	1.3	0.9

**Mechanical Properties**

Yield Strength (N/mm <sup>2</sup> )	Tensile Strength (N/mm <sup>2</sup> )	Impact Strength (ISO-V/-60°C)	Elongation (L <sub>0</sub> =5d <sub>0</sub> ) (%)
min. 460	530-680	min. 47 J	min. 20

**Typical Base Material Grades**

- E295, E335, S355J2G3, L210-L360NB, L210MB-L360MB, P310GH, P355GH, S380N-S460N, P380NH-P460NH, S380NL-S460NL, S255NL1-S420NL1, GE260-GE300
- API 5L: X42, X46, X52, X56, X60, X65

**Features and Applications**

- Content with Mn-Ni alloy
- High toughness and high resistance to cracking
- Suitability for use in welding high strength, fine-grained structural steels
- Suitability for use in welding of materials with service temperatures between -60°C and +350°C
- Very high values of impact resistance after aging
- Convenience of welding at all positions except for vertical down position
- Weld deposits with very low contents of hydrogen
- Requirement of re-drying for minimum 2 hours at the temperatures between 300°C and 350°C

**Welding Positions**

**Current Type**

D.C. (+)

**Operating Data**

Product Code	Diameter x Length (mm) / (inch)		Welding Current (A)	Weight g / 100 pcs
3010100483	2.50 x 350	3/32 x 14"	80 - 110	2190
3010100486	3.20 x 350	1/8 x 14"	100 - 140	3570
3010100495	4.00 x 450	5/32 x 18"	130- 190	6660
3010100498	5.00 x 450	3/16 x 18"	190-240	10550

**Approvals:** TSE, CE, DNV-GL, GOST-R, SEPRO

**Standards**

TS EN ISO 2560-A	: E 50 3 B 42 H5
EN ISO 2560-A	: E 50 3 B 42 H5
AWS A5.5	: E 8018-G H4

**Chemical Composition of  
Weld Metal % (Typical)**

C	Si	Mn
0.06	0.7	1.6

**Mechanical Properties**

Yield Strength (N/mm <sup>2</sup> )	Tensile Strength (N/mm <sup>2</sup> )	Impact Strength (ISO-V/-30°C)	Elongation (L <sub>0</sub> =5d <sub>0</sub> ) (%)
min. 500	550-720	min. 47 J	min. 19

**Typical Base Material Grades**

- S355J2G3, E295-E360, C35-C60, S315N-S500N, P315NH-P500NH, GE240-GE340  
Resistance of the rail steels up to 785 N/mm<sup>2</sup> are used.
- API 5L: X52, X56, X60, X65, X70

**Features and Applications**

- Suitability for use in welding carbon and low-alloyed high-strength steels with carbon contents up to 0.6%
- Suitability for use in rail-joint welding
- Ductile and crack-resistant weld metals
- Recovery of weld metals about 115%
- Weldability at all positions except for vertical down positions
- Weld deposits with very low contents of hydrogen
- Requirement of re-drying for minimum 2 hours at the temperatures between 350°C and 400°C

**Welding Positions**

**Current Type**

D.C.(+)

**Operating Data**

Product Code	Diameter x Length (mm) / (inch)		Welding Current (A)	Weight g / 100 pcs
3010100501	2.50 x 350	3/32 x 14"	80-110	2220
3010100504	3.20 x 350	1/8 x 14"	100 - 140	3590
3010100507	4.00 x 450	5/32 x 18"	130-190	6820
3010100510	5.00 x 450	3/16 x 18"	190 - 240	10500

**Approvals:** TSE, CE, GOST-R, SEPRO

**Standards**

TS EN ISO 18275-A	: E 55 6 1 NiMo B 42 H5
EN ISO 18275-A	: E 55 6 1 NiMo B 42 H5
AWS A5.5	: E 8018 - G H4

**Chemical Composition of  
Weld Metal % (Typical)**

C	Si	Mn	Ni	Mo
0.06	0.3	1.2	0.8	0.35

**Mechanical Properties\***

Yield Strength (N/mm <sup>2</sup> )	Tensile Strength (N/mm <sup>2</sup> )	Impact Strength (ISO-V/-60°C)	Elongation (L <sub>0</sub> =5d <sub>0</sub> ) (%)
min. 550	630-750	min. 47 J	min. 19

\* CTOD tested

**Typical Base Material Grades**

- E295-E360, 20MnMoNi5-5, 22NiMoCr4-7, S380N-S500N, S380NH-S500NH, S380NL-S500NL, S380NL1- S500NL1, 15NiCuMoNb5S, 17MnMoV6-4, C35-C60, GS60,
- API 5L: X52, X56, X60, X65, X70

**Features and Applications**

- Suitability for use in welding high-strength, fine-grained steels
- Consistent high ductility and crack-resistance at low working temperatures down to -60°C
- Resistance to aging
- Convenience of welding at all positions except for the vertical down position
- Possibility of applying same heat treatments temperatures at pre- and post- welding as well as at transition stages as those of base metal
- Very low contents of hydrogen
- Requirement of re-drying for minimum 2 hours at the temperatures between 300°C and 350°C

**Welding Positions**

**Current Type**

D.C.(+) / D.C. (-) for root pass

**Operating Data**

Product Code	Diameter x Length (mm) / (inch)		Welding Current (A)	Weight g / 100 pcs
3010100513	2.50 x 350	3/32 x 14"	80 - 110	2200
3010100516	3.20 x 350	1/8 x 14"	100 - 140	3640
3010100522	4.00 x 450	5/32 x 18"	130 - 190	6800
3010100528	5.00 x 450	3/16 x 18"	190-240	10500

**Approvals:** CE, ABS, GOST-R, SEPRO

**Standards**

TS EN ISO 18275-A	: E 55 6 Z (1 NiMo) B 42 H5
EN ISO 18275-A	: E 55 6 Z (1 NiMo) B 42 H5
AWS A5.5	: E 9018-M H4

**Chemical Composition of  
Weld Metal % (Typical)**

C	Si	Mn	Ni	Mo
0.05	0.3	1.1	1.4	0.3

**Mechanical Properties**

Yield Strength (N/mm <sup>2</sup> )	Tensile Strength (N/mm <sup>2</sup> )	Impact Strength (ISO-V/-60°C)	Elongation (L <sub>0</sub> =5d <sub>0</sub> ) (%)	Heat Treatment
min. 550	620-780	min. 47 J	min. 24	AW

**Typical Base Material Grades**

- S380N-S500N, S355NH-S460NH, S380NL-500NL
- Fine grained, high strength steels and steel castings
- API 5L: X52, X56, X60, X65, X70

**Features and Applications**

- High resistance to cracking
- Low amounts of Hydrogen (4 ml / 100 g)
- Operability at temperatures between - 60°C and + 350°C
- Low content of moisture absorbed during long-term storage
- Requirement of re-drying for minimum 2 hours at the temperatures between 300°C and 350°C

**Welding Positions**

**Current Type**

D.C.(+)

**Operating Data**

Product Code	Diameter x Length (mm) / (inch)		Welding Current (A)	Weight g / 100 pcs
3010100546	2.50 x 350	3/32 x 14"	80 - 110	2250
3010100549	3.20 x 350	1/8 x 14"	100- 140	3640
3010100552	4.00 x 450	5/32 x 18"	130 - 190	6880
3010100555	5.00 x 450	3/16 x 18"	190 - 240	10130

**Approvals:** GOST-R, CE, SEPRO

**Standards**

TS EN ISO 18275-A	: E 55 6 2 NiMo BT 42 H5
EN ISO 18275-A	: E 55 6 2 NiMo BT 42 H5
AWS A5.5	: E 9018 - G H4

**Chemical Composition of  
Weld Metal % (Typical)**

C	Si	Mn	Ni	Mo
0.07	0.2	0.6	2.4	0.4

**Mechanical Properties**

Yield Strength (N/mm <sup>2</sup> )	Tensile Strength (N/mm <sup>2</sup> )	Impact Strength (ISO-V/-60°C)	Elongation (L <sub>0</sub> =5d <sub>0</sub> ) (%)	Heat Treatment
min. 550	620-780	min. 47 J	min. 18	560-600°C / 1 h / 300°C (air)

**Typical Base Material Grades**

- S380N-S500N, S355NH-S460NH, S380NL-500NL
- Fine grained, high alloyed steels and steel castings
- API 5L: X52, X56, X60, X65, X70

**Features and Applications**

- Suitability for use in welding of high-strength , fine-grained steels
- High ductility and high resistance to cracking obtained in welding fine-grained steels
- Suitability for use in welding of materials with service temperatures between -60°C and +350°C
- Requirement of re-drying for minimum 2 hours at the temperatures between 300°C and 350°C

**Welding Positions**

**Current Type**

D.C. (+)

**Operating Data**

Product Code	Diameter x Length (mm) / (inch)		Welding Current (A)	Weight g / 100 pcs
3010100570	2.50 x 350	3/32 x 14"	80 - 110	2320
3010100573	3.20 x 350	1/8 x 14"	100- 140	3670
3010100576	4.00 x 450	5/32 x 18"	130 - 190	6790
3010100579	5.00 x 450	3/16 x 18"	190 - 240	10130

**Approvals:** GOST-R, CE, ABS, SEPRO

**Standards**

TS EN ISO 18275-A	: E 55 5 MnMo B 42 H5
EN ISO 18275-A	: E 55 5 MnMo B 42 H5
AWS A5.5	: ~ E 9018-D1 H4

**Chemical Composition of  
Weld Metal % (Typical)**

C	Si	Mn	Mo
0.075	0.4	1.6	0.45

**Mechanical Properties**

Yield Strength (N/mm <sup>2</sup> )	Tensile Strength (N/mm <sup>2</sup> )	Impact Strength (ISO-V/-50°C)	Elongation (L <sub>0</sub> =5d <sub>0</sub> ) (%)	Heat Treatment
min. 550	620-780	min. 47 J	min. 18	560-600°C / 1h / 300°C (air)

**Typical Base Material Grades**

- E295-E360, P355GH, 17MnMoV6-4, 15NiCuMoNb5S, S380N-S500N, P380NH-S500NH, GE300-GE340, G22Mo4
- API 5L: X52, X56, X60, X65, X70

**Features and Applications**

- Suitability for use in welding high-strength, fine-grained constructional steels and high-temperature steels
- Use in welding rail steels with strength values up to 785 N/mm<sup>2</sup>
- Content including MnMo alloy
- Resistance to cracking as well as to aging, high toughness
- Requirement of re-drying for minimum 2 hours at the temperatures between 300°C and 350°C

**Welding Positions**

**Current Type**

D.C.(+)

**Operating Data**

Product Code	Diameter x Length (mm) / (inch)		Welding Current (A)	Weight g / 100 pcs
3010100558	2.50 x 350	3/32 x 14"	80 - 110	2220
3010100561	3.20 x 350	1/8 x 14"	100 - 140	3670
3010100564	4.00 x 450	5/32 x 18"	130 - 190	6790
3010100567	5.00 x 450	3/16 x 18"	190 - 240	10130

**Approvals:** GOST-R, CE, SEPRO



**Standards**

TS EN ISO 18275-A	: E 62 6 Z 1NiMo B 4 2 H5
EN ISO 18275-A	: E 62 6 Z 1NiMo B 4 2 H5
AWS A5.5	: E 10018 - G H4

**Chemical Composition of  
Weld Metal % (Typical)**

C	Si	Mn	Cr	Mo	Ni
0.05	0.5	1.3	0.3	0.5	1.3

**Mechanical Properties**

Yield Strength (N/mm <sup>2</sup> )	Tensile Strength (N/mm <sup>2</sup> )	Impact Strength (ISO-V/-60°C)	Elongation (L <sub>0</sub> =5d <sub>0</sub> ) (%)	Heat Treatment
min. 620	690-890	min. 47 J	min. 18	560-600°C / 1h / 300°C (air)

**Typical Base Material Grades**

- The yield strength of 620 N/mm<sup>2</sup> up to the quenched and tempered fine grain steels
- The tensile strength of the 780 N/mm<sup>2</sup> heat treating steels.

**Features and Applications**

- Content of Mn-Mo-Ni alloy
- High ductility and high resistance to cracking obtained in welding high-strength, quenched and tempered, fine-grained structural steels
- Suitability for use in welding of materials with service temperatures between -60°C and +400°C
- Very high values of impact resistance after aging
- Convenience of welding at all positions except for the vertical down position.
- Possibility of applying same heat treatment temperatures at pre- and post-welding as well as at transition stages as those of base metal
- Weld deposits with very low contents of hydrogen
- Requirement of re-drying for minimum 2 hours at the temperatures between 300°C and 350°C

**Welding Positions**

**Current Type**

D.C. (+)

**Operating Data**

Product Code	Diameter x Length (mm) / (inch)		Welding Current (A)	Weight g / 100 pcs
3010100582	2.50 x 350	3/32 x 14"	80 - 110	2280
3010100585	3.20 x 350	1/8 x 14"	100 - 140	3580
3010100588	4.00 x 450	5/32 x 18"	130 - 190	6680
3010100591	5.00 x 450	3/16 x 18"	190 - 240	10230

**Approvals:** GOST-R, CE, SEPRO

**Standards**

TSENISO18275-A : E 69 5 Mn2NiCrMo B 42 H5
EN ISO 18275-A : E 69 5 Mn2NiCrMo B 42 H5
AWS A5.5 : E11018-MH4

**Chemical Composition of  
Weld Metal % (Typical)**

C	Si	Mn	Cr	Mo	Ni
0.05	0.2	1.6	0.35	0.45	2.2

**Mechanical Properties**

Yield Strength (N/mm <sup>2</sup> )	Tensile Strength (N/mm <sup>2</sup> )	Impact Strength (ISO-V/-50°C)	Elongation (L <sub>0</sub> =5d <sub>0</sub> ) (%)
min. 690	760-960	min. 47 J	min. 20

**Typical Base Material Grades**

- S620QL-S690QL, S620QL 1, HY100
- API 5L: X60, X65, X70, X80

**Features and Applications**

- Basic-type -coated and Ni-Cr-Mo -alloyed electrode character
- Applicability in welding of casting steels and high-strength fine-grained steels
- Weld metals with high resistance to cracking
- Low amounts of hydrogen (4 ml per 100 g of weld metal)
- Low amounts of moisture absorbed during long-term storage
- Requirement of re-drying for minimum 2 hours at the temperatures between 300°C and 350°C

**Welding Positions**

**Current Type**

D.C.(+)

**Operating Data**

Product Code	Diameter x Length (mm) / (inch)		Welding Current (A)	Weight g / 100 pcs
3010100609	2.50 x 350	3/32 x 14"	80 - 110	2250
3010100612	3.20 x 350	1/8 x 14"	100 - 140	3610
3010100618	4.00 x 450	5/32 x 18"	130 - 190	6850
3010100624	5.00 x 450	3/16 x 18"	190 - 240	10520

**Approvals:** CE, ABS, GOST-R, SEPRO

**Standards**

TS EN ISO 18275-A : E 69 5 Z Mn2NiCrMo B 4 2 H5
EN ISO 18275-A : E 69 5 Z Mn2NiCrMo B 4 2 H5
AWS A5.5 : E 12018 - G H4

**Chemical Composition of  
Weld Metal % (Typical)**

C	Si	Cr	Mo	Ni	Mn
0.06	0.4	0.9	0.5	2.5	1.6

**Mechanical Properties**

Yield Strength (N/mm <sup>2</sup> )	Tensile Strength (N/mm <sup>2</sup> )	Impact Strength (ISO-V/-50°C)	Elongation (L <sub>0</sub> =5d <sub>0</sub> ) (%)	Heat Treatment
min. 740	830-950	min. 28 J	min. 17	560-600° C / 1h / 300° C (air)

**Typical Base Material Grades**

- HY 100, S690QL, S690QU, N-AXTRA 70
- API 5L: X60, X65, X70, X80

**Features and Applications**

- Suitability for use in welding fine-grained steels, cementation steels, tempered steels, cast steels etc.
- Suitability for use of applications requiring a minimum tensile strength value of 830 N/mm<sup>2</sup>
- Requirement of re-drying for minimum 2 hours at the temperatures between of 300°C and 350°C

**Welding Positions**

**Current Type**

D.C. (+)

**Operating Data**

Product Code	Diameter x Length (mm) / (inch)		Welding Current (A)	Weight g / 100 pcs
3010100627	3.2 x 350	1/8 x 14"	90 - 140	3670
3010100630	4.0 x 450	5/32 x 18"	130 - 190	6740
3010100633	5.0 x 450	3/16 x 18"	170 - 240	10530

**Approvals:** GOST-R, CE, SEPRO

**Standards**

TS EN ISO 2560-A	: E 42 3 Z NiCrCu B 42 H5
EN ISO 2560-A	: E 42 3 Z NiCrCu B 42 H5
AWS A5.5	: E7018-G/7018-W1(mod.)H4

**Chemical Composition of  
Weld Metal % (Typical)**

C	Si	Cr	Ni	Cu	Mn
0.06	0.5	0.3	0.4	0.4	1.0

**Mechanical Properties**

Yield Strength (N/mm <sup>2</sup> )	Tensile Strength (N/mm <sup>2</sup> )	Impact Strength (ISO-V/-30°C)	Elongation (L <sub>0</sub> =5d <sub>0</sub> ) (%)
min. 420	510 - 630	min. 47 J	min. 22

**Typical Base Material Grades**

- S235JR, S235JRW, S325J2W, S355J2G1W, S355JRW, S355J2G 3 Cu, COR-TEN A

**Features and Applications**

- Content of Ni-Cu-Cr alloy
- Suitability for use in welding structural steels exposed to weathering, such as COR-TEN.
- High mechanical properties with excellent crack resistance
- Convenience of welding at all positions except for vertical down position
- Weld deposits with very low contents of hydrogen
- Requirement of re-drying for minimum 2 hours at the temperatures between of 300°C and 350°C

**Welding Positions**

**Current Type**

D.C.(+)

**Operating Data**

Product Code	Diameter x Length (mm) / (inch)		Welding Current (A)	Weight g / 100 pcs
3010100636	2.5 x 350	3/32 x 14"	80-110	2240
3010100639	3.2 x 350	1/8 x 14"	130-150	3520
3010100645	4.0 x 450	5/32 x 18"	150-190	6580
3010100648	5.0 x 450	3/16 x 18"	200-250	10100

**Approvals:** TSE, CE, GOST-R, SEPRO

**Standards**

TS EN ISO 2560-A	: E 46 6 Z NiCrCu B 42 H5
EN ISO 2560-A	: E 46 6 Z NiCrCu B 42 H5
AWS A5.5	: E 8018 -W2 H4

**Chemical Composition of  
Weld Metal % (Typical)**

C	Si	Cr	Ni	Cu	Mn
0.06	0.45	0.5	0.5	0.4	0.7

**Mechanical Properties**

Yield Strength (N/mm <sup>2</sup> )	Tensile Strength (N/mm <sup>2</sup> )	Impact Strength (ISO-V/-60°C)	Elongation (L <sub>0</sub> =5d <sub>0</sub> ) (%)
min. 460	550 - 680	min. 47 J	min. 20

**Typical Base Material Grades**

- S235JR, S235JRW, S325J2W, S355J2G1W, S355JRW, S355J2G 3 Cu, Patinax 37, 9CrNiCuP3-2-4 S255-S460, COR-TEN A,B,C

**Features and Applications**

- Content of Ni-Cu-Cr alloy
- Suitability for use in welding structural steels exposed to weathering, especially for COR-TEN B type steels.
- High mechanical properties with excellent crack resistance
- Convenience of welding at all positions except for vertical down position
- Weld deposits with very low contents of hydrogen
- Requirement of re-drying for minimum 2 hours at the temperatures between of 300°C and 350°C

**Welding Positions**

**Current Type**

D.C. (+)

**Operating Data**

Product Code	Diameter x Length (mm) / (inch)		Welding Current (A)	Weight g / 100 pcs
3010100651	2.50 x 350	3/32 x 14"	80 - 110	2200
3010100654	3.20 x 350	1/8 x 14"	130 - 150	3550
3010100657	4.00 x 450	5/32 x 18"	150 - 190	6700

**Approvals:** GOST-R, CE, SEPRO

## Standards

TS EN ISO 2560-A	: E 46 6 1 Ni B 42 H5
EN ISO 2560-A	: E 46 6 1 Ni B 42 H5
AWS A5.5	: E 8018 -C3 H4

## Chemical Composition of Weld Metal % (Typical)

C	Si	Mn	Mo	Ni
0.07	0.3	1.0	0.15	1.0

## Mechanical Properties

Yield Strength (N/mm <sup>2</sup> )	Tensile Strength (N/mm <sup>2</sup> )	Impact Strength (ISO-V/-60°C)	Elongation (L <sub>0</sub> =5d <sub>0</sub> ) (%)
min. 470	550-680	min. 47 J	min. 24

## Typical Base Material Grades

- 11 MnNi53, 13MnNi63, TTSt35N, TTSt35V, TTSt41, TTSt45, S255N-S500N, S255NL-S500NL

## Features and Applications

- Suitability for use in welding low-alloyed steels resistant to lower service temperatures
- Serviceability of weld metals at temperatures down to -60°C
- Weld metal recovery of approx. 120%
- Requirement of re-drying for minimum 2 hours at the temperatures between 300°C and 350°C

## Welding Positions

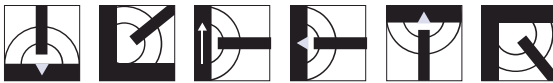

## Current Type

D.C.(+)

## Operating Data

Product Code	Diameter x Length (mm) / (inch)		Welding Current (A)	Weight g / 100 pcs
3010100660	2.50 x 350	3/32 x 14"	70 - 100	2190
3010100663	3.20 x 350	1/8 x 14"	110 - 140	3440
3010100669	4.00 x 350	5/32 x 14"	140 - 180	5130
3010100672	4.00 x 450	5/32 x 18"	140 - 190	6650
3010100678	5.00 x 450	3/16 x 18"	190 - 240	10500

**Approvals:** TSE, CE, GOST-R, SEPRO

**Standards**

TS EN ISO 2560-A	: E 46 6 2 Ni B 42 H5
EN ISO 2560-A	: E 46 6 2 Ni B 42 H5
AWS A5.5	: E8018-C1 H4

**Chemical Composition of  
Weld Metal % (Typical)**

C	Si	Mn	Ni
0.05	0.3	0.8	2.4

**Mechanical Properties**

Yield Strength (N/mm <sup>2</sup> )	Tensile Strength (N/mm <sup>2</sup> )	Impact Strength (ISO-V/-80°C)	Elongation (L <sub>0</sub> =5d <sub>0</sub> ) (%)	Heat Treatment
min. 460	550 - 690	min. 47 J	min. 20	605°C / 2h / 300°C (air)

**Typical Base Material Grades**

- 12Ni14, 14Ni6, 13MnNi6-3, G12Ni14, S255N-S460N, S255NH-S460NH, S255NL-S460NL, S255NL1-S460NL 1, TTS135/N/V, TTS145N/V

**Features and Applications**

- Suitability for use in welding fine-grained, Ni-alloyed and carbon steels as well as cryogenic steels
- High ductility and crack resistance in weld deposits
- Serviceability of weld metals at temperatures down to -80°C
- Weld metal recovery of approx. 120%
- Convenience of welding at all positions except for vertical down position
- Possibility of applying same heat treatment temperatures at pre- and post-welding as well as at transition stages as those of base metal
- Weld deposits with very low contents of hydrogen
- Requirement of re-drying for minimum 2 hours at the temperatures between 300°C and 350°C

**Welding Positions**

**Current Type**

D.C. (+)

**Operating Data**

Product Code	Diameter x Length (mm) / (inch)		Welding Current (A)	Weight g / 100 pcs
3010100681	2.50 x 350	3/32 x 14"	70 - 100	2170
3010100684	3.20 x 350	1/8 x 14"	110 - 140	3700
3010100687	4.00 x 450	5/32 x 18"	140 - 180	6900
3010100690	5.00 x 450	3/16 x 18"	190 - 230	10500

**Approvals:** TSE, CE, GOST-R, SEPRO

**Standards**

TS EN ISO 2560-A	: E 46 6 3 Ni B 42 H5
EN ISO 2560-A	: E 46 6 3 Ni B 42 H5
AWS A5.5	: E 8018-C2 H4

**Chemical Composition of  
Weld Metal % (Typical)**

C	Si	Mn	Ni
0.05	0.3	0.7	3.2

**Mechanical Properties**

Yield Strength (N/mm <sup>2</sup> )	Tensile Strength (N/mm <sup>2</sup> )	Impact Strength (ISO-V/-100°C)	Elongation (L <sub>0</sub> =5d <sub>0</sub> ) (%)	Heat Treatment
min. 460	550 - 700	min. 47 J	min. 24	605°C / 2h / 300°C (air)

**Typical Base Material Grades**

- Cold-tough steels: 10 Ni14, 16Ni16, S 255NL1-SS00NL1, S275NL2-P460NL2

**Features and Applications**

- Suitability for use in welding Ni-alloyed construction steels for cryogenic applications
- High ductility and crack resistance in weld deposits
- Serviceability of weld metals at temperatures down to -110°C
- Weld metal recovery of approx. 120%
- Convenience of welding at all positions except for vertical down position
- Weld deposits with very low contents of hydrogen
- Requirement of re-drying for minimum 2 hours at the temperatures between 300°C and 350°C

**Welding Positions**

**Current Type**

D.C.(+)

**Operating Data**

Product Code	Diameter x Length (mm) / (inch)		Welding Current (A)	Weight g / 100 pcs
3010100693	2.50 x 350	3/32 x 14"	70 - 110	2220
3010100696	3.20 x 350	1/8 x 14"	110 - 140	3650
3010100702	4.00 x 450	5/32 x 18"	140 - 180	6600
3010100705	5.00 x 450	3/16 x 18"	190 - 230	10500

**Approvals:** TSE, CE, GOST-R, SEPRO



**Standards**

TS EN ISO 3580-A : E Mo R 12
EN ISO 3580-A : E Mo R 12

**Chemical Composition of  
Weld Metal % (Typical)**

C	Si	Mn	Mo
0.07	0.4	0.6	0.5

**Mechanical Properties**

Yield Strength (N/mm <sup>2</sup> )	Tensile Strength (N/mm <sup>2</sup> )	Impact Strength (ISO-V/+20°C)	Elongation (L <sub>0</sub> =5d <sub>0</sub> ) (%)	Heat Treatment
355	min. 510	min. 47 J	min. 22	570-620°C / 1h / 300°C (air)

**Typical Base Material Grades**

- S355J2G3, E295, P255G1TH, L320- L415NB, 16Mo3, L290MB-L415MB, 16Mo3, S255N, P295GH, P355GH, P255-P355N, P255NH-P355NH

**Features and Applications**

- Welding of heat-resistant Mo-alloyed, fine-grained or unalloyed steels used for construction of boilers and pipes
- Weld metal is resistant to working temperatures up to +550°C

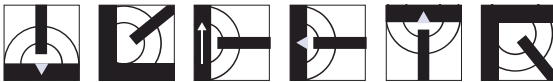
**Welding Positions**

**Current Type**

D.C. (+)

**Operating Data**

Product Code	Diameter x Length (mm) / (inch)		Welding Current (A)	Weight g / 100 pcs
3010100708	2.50 x 350	3/32 x 14"	80 - 100	2080
3010100711	3.20 x 350	1/8 x 14"	110-140	3310
3010100714	4.00 x 350	5/32 x 14"	140- 190	4900
3010100717	5.00 x 350	3/16 x 14"	190 - 240	7540

**Approvals:** CE, GOST-R, SEPRO

**Standards**

TS EN ISO 3580-A	: E Mo B 42 H5
EN ISO 3580-A	: E Mo B 42 H5
AWS A5.5	: E 7018-A1 H4

**Chemical Composition of  
Weld Metal % (Typical)**

C	Si	Mn	Mo
0.07	0.4	0.9	0.5

**Mechanical Properties**

Yield Strength (N/mm <sup>2</sup> )	Tensile Strength (N/mm <sup>2</sup> )	Impact Strength (ISO-V/-50°C)	Elongation (L <sub>0</sub> =5d) (%)	Heat Treatment
min. 460	530 - 670	min. 47 J	min. 22	620°C / 1h / 300°C (air)

**Typical Base Material Grades**

- S355J2G3, E295, E335, P255G1TH, 16Mo3, L320-L415NB, L290MB-L415MB, S255N-S460N, P295GH P355GH, 15NiCuMoNb5S, 20MnMoNi4-5, 17MnMoV6-4, S255NH-S460NH, S255NL-S460NL, GE240-GE300, GS22Mo4

**Features and Applications**

- Basic-coated stick electrode
- Welding of heat-resisting, Mo-alloyed, thin-walled and unalloyed steels used for construction of boilers and pipes
- Weld metal is resistant to working temperatures from -50°C to +550°C  
Re-drying: 300-350°C min. 2h

**Welding Positions**

**Current Type**

D.C.(+)

**Operating Data**

Product Code	Diameter x Length (mm) / (inch)		Welding Current (A)	Weight g / 100 pcs
3010100720	2.50 x 350	3/32 x 14"	80 - 110	2200
3010100723	3.20 x 350	1/8 x 14"	100 - 140	3560
3010100729	4.00 x 450	5/32 x 18"	140 - 190	6590
3010100735	5.00 x 450	3/16 x 18"	190 - 240	10160

**Approvals:** TÜV, GOST-R, DB, CE, SEPRO

**Standards**

TS EN ISO 3580-A	: E CrMo1 R 12
EN ISO 3580-A	: E CrMo1 R 12
AWS A5.5	: E 8013-G

**Chemical Composition of  
Weld Metal % (Typical)**

C	Si	Mn	Mo	Cr
0.06	0.4	0.6	0.5	1.1

**Mechanical Properties**

Yield Strength (N/mm <sup>2</sup> )	Tensile Strength (N/mm <sup>2</sup> )	Impact Strength (ISO-V/+20°C)	Elongation (L <sub>0</sub> =5d <sub>0</sub> ) (%)	Heat Treatment
min. 460	min. 550	min. 47 J	min. 20	660-700°C / 1h / 300°C (air)

**Typical Base Material Grades**

- 13CrMo4-5, 15CrMo5, 16CrMoV4, S355NH

**Features and Applications**

- Welding of steam production plant equipments, steam pipes and similar kinds of heat-resistant joints, all of which are made of Cr-Mo alloy steels
- Electrode coating of rutile character
- Resistance of weld metal to operating temperatures of values up to 570°C

**Welding Positions**

**Current Type**

D.C. (-)  
A.C.

**Operating Data**

Product Code	Diameter x Length (mm) / (inch)		Welding Current (A)	Weight g / 100 pcs
3010100738	2.50 x 350	3/32 x 14"	80 - 110	2150
3010100741	3.20 x 350	1/8 x 14"	100 - 140	3420
3010100744	4.00 x 350	5/32 x 14"	140 - 190	4760

**Approvals:** CE, GOST-R, SEPRO

**Standards**

TS EN ISO 3580-A	: E CrMo1 B 42 H5
EN ISO 3580-A	: E CrMo1 B 42 H5
AWS A5.5	: E 8018-B2 H4

**Chemical Composition of  
Weld Metal % (Typical)**

C	Si	Mn	Mo	Cr
0.07	0.5	0.8	0.5	1.1

**Mechanical Properties**

Yield Strength (N/mm <sup>2</sup> )	Tensile Strength (N/mm <sup>2</sup> )	Impact Strength (ISO-V/+20°C)	Elongation (L <sub>0</sub> =5d <sub>0</sub> ) (%)	Heat Treatment
min. 460	min. 550	min. 47 J	min. 20	690°C / 1h / 300°C (air)

**Typical Base Material Grades**

- 13CrMo4-5, 15CrMo5, 16CrMoV4, G17CrMo5-5, GS22Mo4, G22CrMo5-4, A193 Gr.B7, A335 Gr.P11

**Features and Applications**

- Steam boilers and steam pipes made of Cr-Mo-alloyed heat-resistant steels
- Cementation steels, nitrided steels
- Electrode coating of basic character
- Requirement of re-drying for 2 hours at the temperatures between 300°C and 350°C

**Welding Positions**

**Current Type**

D.C.(+)

**Operating Data**

Product Code	Diameter x Length (mm) / (inch)		Welding Current (A)	Weight g / 100 pcs
3010100747	2.50 x 350	3/32 x 14"	80 - 110	2190
3010100750	3.20 x 350	1/8 x 14"	100 - 140	3520
3010100756	4.00 x 450	5/32 x 18"	140 - 190	6790
3010100759	5.00 x 450	3/16 x 18"	190 - 240	10020

**Approvals:** GOST-R, CE, SEPRO

**Standards**

TS EN ISO 3580-A	: E CrMo1 B 42 H5
EN ISO 3580-A	: E CrMo1 B 42 H5
AWS A5.5	: E 8015-B2 H4

**Chemical Composition of  
Weld Metal % (Typical)**

C	Si	Mn	Mo	Cr
0.07	0.5	0.8	0.5	1.1

**Mechanical Properties**

Yield Strength (N/mm <sup>2</sup> )	Tensile Strength (N/mm <sup>2</sup> )	Impact Strength (ISO-V/+20°C)	Elongation (L <sub>0</sub> =5d <sub>0</sub> ) (%)	Heat Treatment
min. 460	580 - 740	min. 47 J	min. 20	690°C / 1h / 300°C (air)

**Typical Base Material Grades**

- 13CrMo4-5, 15CrMo5, 16CrMoV4, G17CrMo5-5, GS22Mo4, G22CrMo5-4, A193 Gr.B7, A335 Gr.P11,

**Features and Applications**

- Welding of steam boilers and steam pipes made of Cr-Mo alloyed heat resistant steels, cementation steels, nitrided steels
- Resistance of weld metal to operating temperatures of values up to 570°C.
- Weld metal recovery of approx. 125%
- It can be used in position welding with lower heat input
- Usable with short arc in (-) pole for root pass welding with excellent penetration
- Requirement of re-drying for minimum 2 hours at the temperatures between 300°C and 350°C

**Welding Positions**

**Current Type**

D.C. (+)

**Operating Data**

Product Code	Diameter x Length (mm) / (inch)		Welding Current (A)	Weight g / 100 pcs
3010100762	2.50 x 350	3/32 x 14"	80 - 110	2190
3010100765	3.20 x 350	1/8 x 14"	100 - 140	3740
3010100771	4.00 x 450	5/32 x 18"	140 - 190	6750
3010100774	5.00 x 450	3/16 x 18"	190 - 240	10020

**Approvals:** CE, GOST-R, SEPRO

**Standards**

TS EN ISO 3580-A	: E CrMo1L B 4 2 H5
EN ISO 3580-A	: E CrMo1L B 4 2 H5
AWS A5.5	: E 7018-B2 L H4

**Chemical Composition of  
Weld Metal % (Typical)**

C	Si	Mn	Mo	Cr
<0.05	0.6	0.8	0.5	1.1

**Mechanical Properties**

Yield Strength (N/mm <sup>2</sup> )	Tensile Strength (N/mm <sup>2</sup> )	Impact Strength (ISO-V/+20°C)	Elongation (L <sub>0</sub> =5d <sub>0</sub> ) (%)
min. 460	min. 550	min. 47 J	min. 20

**Typical Base Material Grades**

- 13CrMo4-5, 15CrMo5, 16CrMoV4, G17CrMo5-5, GS-22Mo4, GS-22 CrMo5-4, A 193 Gr B7, A335 Gr P11, P12

**Features and Applications**

- Applicability in welding heat-resisting, low-alloyed steels
- Suitability to use against corrosion in sour crude, and against stress corrosion in petrochemical industry
- Requirement of re-drying for min. 2 hours at the temperatures between 300°C and 350°C

**Welding Positions**

**Current Type**

D.C.(+)

**Operating Data**

Product Code	Diameter x Length (mm) / (inch)		Welding Current (A)	Weight g / 100 pcs
3010100777	2.50 x 350	3/32 x 14"	80 - 110	2220
3010100780	3.20 x 350	1/8 x 14"	100 - 140	3520
3010100783	4.00 x 450	5/32 x 18"	140 - 190	6790
3010100786	5.00 x 450	3/16 x 18"	190 - 240	10020

**Approvals:** GOST-R, CE, SEPRO

**Standards**

TS EN ISO 3580-A	: E MoV B 42 H5
EN ISO 3580-A	: E MoV B 42 H5
AWS A5.5	: E 9018-G H4

**Chemical Composition of  
Weld Metal % (Typical)**

C	Si	Mn	Mo	Cr	V
0.06	0.3	1.2	1.0	0.45	0.5

**Mechanical Properties**

Yield Strength (N/mm <sup>2</sup> )	Tensile Strength (N/mm <sup>2</sup> )	Impact Strength (ISO-V/+20°C)	Elongation (L <sub>0</sub> =5d <sub>0</sub> ) (%)	Heat Treatment
min. 530	min. 620	min. 47 J	min. 18	710 ±20 °C / 1h / 300°C (air)

**Typical Base Material Grades**

- 14MoV6-3, 24CrMoV5-5, 21CrMoV5-7, 21CrMoV5-11, G17CrMoV5-11

**Features and Applications**

- V-alloyed steels such as 14MoV6-3
- Electrode coating of basic character
- Serviceability at temperatures up to 580°C
- Pre-heating and interpass temperatures : 200°C-300°C
- Requirement of re-drying for min. 2 hours at the temperatures between 300°C and 350°C

**Welding Positions**

**Current Type**

D.C.(+)

**Operating Data**

Product Code	Diameter x Length (mm) / (inch)		Welding Current (A)	Weight g / 100 pcs
3010100789	2.50 x 350	3/12 x 14"	65 - 90	2180
3010100792	3.20 x 350	1/8 x 14"	90 - 130	3180
3010100795	4.00 x 350	5/32 x 14"	140 - 180	5160

**Approvals:** CE, GOST-R, SEPRO

**Standards**

TS EN ISO 3580-A	: E CrMo2 B 42 H5
EN ISO 3580-A	: E CrMo2 B 42 H5
AWS A5.5	: E 9018-B3 H4

**Chemical Composition of  
Weld Metal % (Typical)**

C	Si	Mn	Mo	Cr
0.07	0.4	0.8	1.0	2.2

**Mechanical Properties**

Yield Strength (N/mm <sup>2</sup> )	Tensile Strength (N/mm <sup>2</sup> )	Impact Strength (ISO-V/+20°C)	Elongation (L <sub>0</sub> =5d <sub>0</sub> ) (%)	Heat Treatment
min. 530	min. 620	min. 47 J	min. 18	690-750°C / 1h / 300°C (air)

**Typical Base Material Grades**

- 10CrMo9-10, 10CrSiMoV7, G-18CrMo9-10, A335 Gr. P22

**Features and Applications**

- Welding of steam boilers, steam pipes made of Cr-Mo-alloyed steels, nitrided steels, not-heat treated cementation steels
- Resistance of weld metal to working temperatures up to 600°C
- Requirement of re-drying for min. 2 hours at the temperatures between 300°C and 350°C

**Welding Positions**

**Current Type**

D.C.(+)

**Operating Data**

Product Code	Diameter x Length (mm) / (inch)		Welding Current (A)	Weight g / 100 pcs
3010100801	2.50 x 350	3/32 x 14"	80 - 110	2280
3010100804	3.20 x 350	1/8 x 14"	100 - 140	3490
3010100810	4.00 x 450	5/32 x 18"	130 - 180	6860
3010100813	5.00 x 450	3/16 x 18"	190 - 240	10010

**Approvals:** GOST-R, CE, SEPRO



**Standards**

TS EN ISO 3580-A	: E CrMo2 B 42 H5
EN ISO 3580-A	: E CrMo2 B 42 H5
AWS A5.5	: E 9015-B3 H4

**Chemical Composition of  
Weld Metal % (Typical)**

C	Si	Mn	Mo	Cr
0.07	0.5	0.8	1.0	2.2

**Mechanical Properties**

Yield Strength (N/mm <sup>2</sup> )	Tensile Strength (N/mm <sup>2</sup> )	Impact Strength (ISO-V/+20°C)	Elongation (L <sub>0</sub> =5d <sub>0</sub> ) (%)	Heat Treatment
min. 530	min. 620	min. 47 J	min. 18	690-750°C / 1h / 300°C (air)

**Typical Base Material Grades**

- 10CrMo9-10, 10CrMo5MoV7, G18CrMo9-6, A 335 Gr. P 22

**Features and Applications**

- Welding of steam boilers, steam pipes made of Cr-Mo-alloyed steels, nitrided steels, not-heat treated cementation steels
- Resistance of weld metal to working temperatures up to 600°C
- Requirement of Re-drying for min 2 hours at the temperatures between 300°C and 350°C

**Welding Positions**

**Current Type**

D.C.(+)

**Operating Data**

Product Code	Diameter x Length (mm) / (inch)		Welding Current (A)	Weight g / 100 pcs
3010100816	2.50 x 350	3/32 x 14"	80 - 110	2280
3010100819	3.20 x 350	1/8 x 14"	100 - 140	3810
3010100822	4.00 x 450	5/32 x 18"	130 - 180	6920

**Approvals:** CE, GOST-R, SEPRO

**Standards**

TS EN ISO 3580-A	: E CrMo2L B 42 H5
EN ISO 3580-A	: E CrMo2L B 42 H5
AWS A5.5	: E 8018-B3 L H4

**Chemical Composition of  
Weld Metal % (Typical)**

C	Si	Mn	Mo	Cr
0.04	0.6	0.6	1.1	2.2

**Mechanical Properties**

Yield Strength (N/mm <sup>2</sup> )	Tensile Strength (N/mm <sup>2</sup> )	Impact Strength (ISO-V/+20°C)	Elongation (L <sub>0</sub> =5d <sub>0</sub> ) (%)	Heat Treatment
min. 530	min. 620	min. 47 J	min. 18	690-750 °C / 1h / 300°C (air)

**Typical Base Material Grades**

- 2% Cr - 1% Mo Steels, A335 Gr. P22

**Features and Applications**

- Applicability in welding of heat-resisting steels containing 2% Cr - 1% Mn and similar alloys
- Electrode with basic-type coating
- Formation of more ductile and less hard weld metal due to low carbon content
- Serviceability at temperatures of values up to 600 °C
- Recommended pre-heating and post-heat treatment during welding processes
- Requirement of re-drying for min. 2 hours at the temperatures between 300°C and 350°C

**Welding Positions**

**Current Type**

D.C.(+)

**Operating Data**

Product Code	Diameter x Length (mm) / (inch)		Welding Current (A)	Weight g / 100 pcs
3010100825	2.50 x 350	3/32 x 14"	80 - 110	2100
3010100828	3.20 x 350	1/8 x 14"	100 - 140	3480
3010100831	4.00 x 450	5/32 x 18 "	130 - 180	6680

**Approvals:** GOST-R, CE, SEPRO

### Standards

TS EN ISO 3580-A	: E CrMo5 B 42 H5
EN ISO 3580-A	: E CrMo5 B 42 H5
AWS A5.5 (A5.4)	: E 8018-B6 (E 502-15) H4

### Chemical Composition of Weld Metal % (Typical)

C	Si	Mn	Mo	Cr
0.06	0.4	0.8	0.5	5.2

### Mechanical Properties

Yield Strength (N/mm <sup>2</sup> )	Tensile Strength (N/mm <sup>2</sup> )	Impact Strength (ISO-V/+20°C)	Elongation (L <sub>0</sub> =5d <sub>0</sub> ) (%)	Heat Treatment
min. 460	min. 590	min. 47 J	min. 19	730-755°C / 1h / 300°C (air)

### Typical Base Material Grades

- X12CrMo5, GX12CrMo5

### Features and Applications

- High-heat-resistant steels
- In petro chemical industry and on pressured-hydrogen tanks
- Serviceability of weld metal at working temperature up to 650°C
- Requirement of re-drying for min. 2 hours at the temperatures between 300°C and 350°C

### Welding Positions



### Current Type

D.C.(+)

### Operating Data

Product Code	Diameter x Length (mm) / (inch)		Welding Current (A)	Weight g / 100 pcs
3010100834	2.50 x 350	3/32 x 14"	65 - 90	2220
3010100837	3.20 x 350	1/8 x 14"	110 - 130	3630
3010100843	4.00 x 450	5/32 x 18"	140 - 180	6670
3010100846	5.00 x 450	3/16 x 18"	190 - 240	10000

Approvals: GOST-R, CE, SEPRO

**Standards**

TS EN ISO 3580-A	: E CrMo9 B 4 2 H5
EN ISO 3580-A	: E CrMo9 B 4 2 H5
AWS A5.5	: E 8018-B8 H4
AWS A5.4	: E 505-15

**Chemical Composition of  
Weld Metal % (Typical)**

C	Si	Mn	Mo	Cr
0.07	0.4	0.7	1.0	9.0

**Mechanical Properties**

Yield Strength (N/mm <sup>2</sup> )	Tensile Strength (N/mm <sup>2</sup> )	Impact Strength (ISO-V/+20°C)	Elongation (L <sub>0</sub> =5d <sub>0</sub> ) (%)	Heat Treatment
min. 460	min. 590	min. 34 J	min. 19	740-780°C / 2h / 300°C (air)

**Typical Base Material Grades**

- X12CrMo9-1, X7CrMo9-1, GX12CrMo10.

**Features and Applications**

- Welding of boilers, pressure vessel steels, pipe steels and cast steels
- Electrode coating of basic character
- Electrode content of wt% 9 Chromium wt% 1 Molybdenum
- Serviceability at temperatures of values up to 650°C
- Requirement of re-drying for min. 2 hours at the temperatures between 300°C and 350°C

**Welding Positions**

**Current Type**

D.C.(+)

**Operating Data**

Product Code	Diameter x Length (mm) / (inch)		Welding Current (A)	Weight g / 100 pcs
3010100849	2.50 x 350	3/32 x 14"	60 - 90	2330
3010100852	3.20 x 350	1/8 x 14"	90 - 130	3810
3010100855	4.00 x 450	5/32 x 18"	120 - 160	6680

**Approvals:** CE, GOST-R, SEPRO

**Standards**

TS EN ISO 3580-A	: E CrMo9 B 42 H5
EN ISO 3580-A	: E CrMo9 B 42 H5
AWS A5.5	: E 8015-B8 H4

**Chemical Composition of  
Weld Metal % (Typical)**

C	Si	Mn	Mo	Cr
0.07	0.4	0.8	1.0	9.0

**Mechanical Properties**

Yield Strength (N/mm <sup>2</sup> )	Tensile Strength (N/mm <sup>2</sup> )	Impact Strength (ISO-V/+20°C)	Elongation (L <sub>0</sub> =5d <sub>0</sub> ) (%)	Heat Treatment
min. 460	min. 590	min. 34 J	min. 19	740-780 °C / 2h / 300 °C (air)

**Typical Base Material Grades**

- X12CrMo9-1, X7CrMo9-1, A335 Gr. P9

**Features and Applications**

- Heat resistance and low hydrogen electrode with basic-type coating
- Resistance of weld metal to working temperatures up to 650°C
- Welding of pressurized boiler steels, pipe steel and steel castings
- Requirement of re-drying for min. 2 hours at the temperatures between 300°C and 350°C

**Welding Positions**

**Current Type**

D.C.(+)

**Operating Data**

Product Code	Diameter x Length (mm) / (inch)		Welding Current (A)	Weight g / 100 pcs
3010100858	3.20 x 350	1/8 x 14"	90 - 130	3800
3010100861	4.00 x 350	5/32 x 14"	120 - 160	5200

**Approvals:** GOST-R, CE, SEPRO

**Standards**

TS EN ISO 3580-A	: E CrMo91 B 42 H5
EN ISO 3580-A	: E CrMo91 B 42 H5
AWS A5.5	: E9018-B91 H4

**Chemical Composition of  
Weld Metal % (Typical)**

C	Si	Mn	Cr	Mo	Ni	V	Nb	N
0.09	0.2	0.5	9.0	1.0	0.6	0.2	0.04	+

**Mechanical Properties**

Yield Strength (N/mm <sup>2</sup> )	Tensile Strength (N/mm <sup>2</sup> )	Impact Strength (ISO-V/+20°C)	Elongation (L <sub>0</sub> =5d <sub>0</sub> ) (%)	Heat Treatment
min. 530	min. 620	min. 47 J	17	745-775°C / 2h / 300°C (air)

**Typical Base Material Grades**

- X10CrMoVNb 9-1, A213 Gr. T91, A 335 Gr. P91 (T91), A 139Gr.T91, % 9-12 Cr type martensitic stainless steels.

**Features and Applications**

- High- alloyed low-hydrogen electrode with basic-type coating
- Resistance to heat and creep, high resistance to creeping and high toughness values under long-term stress
- Weld metal's resistance to high temperatures up to 620°C
- Pre-heating and inter-pass welding temperature : 200°C - 315°C
- Requirement of re-drying for min. 2 hours at the temperatures between 300°C and 350°C

**Welding Positions**

**Current Type**

D.C.(+)/ D.C.(-) for root pass

**Operating Data**

Product Code	Diameter x Length (mm) / (inch)		Welding Current (A)	Weight g / 100 pcs
3010100873	2.50 x 350	3/32 x 14"	80 - 110	2220
3010100876	3.20 x 350	1 / 8 x 14"	110 - 140	3560
3010100879	4.00 x 350	5/32 x 14 "	140 - 190	5250

**Approvals:** CE, GOST-R, SEPRO

## Standards

TS EN ISO 3580-A	: E CrMo91 B 42 H5
EN ISO 3580-A	: E CrMo91 B 42 H5
AWS A5.5	: E9015-B91 H4

## Chemical Composition of Weld Metal % (Typical)

C	Si	Mn	Cr	Mo	Ni	V	Nb	N
0.09	0.2	0.5	9.0	1.0	1.0	0.2	0.04	+

## Mechanical Properties

Yield Strength (N/mm <sup>2</sup> )	Tensile Strength (N/mm <sup>2</sup> )	Impact Strength (ISO-V/+20°C)	Elongation (L <sub>0</sub> =5d <sub>0</sub> ) (%)	Heat Treatment
min. 530	min. 620	min. 47 J	min. 17	745-775°C / 2h / 300°C (air)

## Typical Base Material Grades

- X10CrMoVNb 9-1, A213 Gr. T91, A 335 Gr. P91 (T91), A 139Gr.T91, % 9-12 Cr type martensitic stainless steels.

## Features and Applications

- High- alloyed low-hydrogen electrode with basic-type coating
- Resistance to heat and creep, high resistance to creeping and high toughness values under long-term stress
- Weld metal's resistance to high temperatures up to 620°C
- Pre-heating and inter-pass welding temperature: 200°C - 315°C,
- Requirement of re-drying for min. 2 hours at the temperatures between 300°C and 350°C

## Welding Positions



## Current Type

D.C.(+)/ D.C.(-) for root pass

## Operating Data

Product Code	Diameter x Length (mm) / (inch)		Welding Current (A)	Weight g / 100 pcs
3010100882	2.50 x 350	3/32 x 14"	80 - 110	2300
3010100885	3.20 x 350	1/8 x 14"	110 - 140	3650
3010100888	4.00 x 350	5/32 x 14"	140 - 190	5250

**Approvals:** GOST-R, CE, SEPRO

**Standards**
**Chemical Composition of  
Weld Metal % (Typical)**

AWS A5.5 : E 9018-B92 (mod.)

C	Si	Mn	Cr	Mo	Ni	W
0.08	0.25	0.65	8.5	0.5	0.75	1.8

**Mechanical Properties**

Yield Strength (N/mm <sup>2</sup> )	Tensile Strength (N/mm <sup>2</sup> )	Impact Strength (ISO-V/+20°C)	Elongation (L <sub>0</sub> =5d <sub>0</sub> ) (%)	Heat Treatment
min. 550	min. 650	min. 47 J	min. 19	745-775°C / 4h / 300°C (air)

**Typical Base Material Grades**

- T/P92, 9%Cr, 1.7%W, 0.5%Mo., creep resisting martensitic steels:  
ASTM: A213 Gr T92, A 335 Gr P92, A387 Gr 92

**Features and Applications**

- Recommended for welding of heat resistant steels T/P92 which are used for steam tubing, turbine casings and power generating casts
- Provides creep strength and toughness at elevated temperatures with additional alloying elements
- Weld metal is resistant to temperatures up to +650°C
- Bruscato factor of X<15
- Preheat and interpass temperature 200°C-315°C
- Requirement of re-drying for min. 2 hours at the temperatures between 300°C and 350°C

**Welding Positions**

**Current Type**

D.C.(+)

**Operating Data**

Product Code	Diameter x Length (mm) / (inch)		Welding Current (A)	Weight g / 100 pcs
3010102273	3.20 x 350	1/8 x 14"	110 - 140	3800

**Approvals: SEPRO**



**Standards**

TS EN ISO 3581-A	: E 18 8 Mn B 22
EN ISO 3581-A	: E 18 8 Mn B 22
AWS A5.4	: ~E 307-15

**Chemical Composition of  
Weld Metal % (Typical)**

C	Si	Mn	Ni	Cr
0.1	0.7	6.0	8.6	18.5

**Mechanical Properties**

Yield Strength (N/mm <sup>2</sup> )	Tensile Strength (N/mm <sup>2</sup> )	Impact Strength (ISO-V/+20°C)	Elongation (L <sub>0</sub> =5d <sub>0</sub> ) (%)
min. 390	580-750	min. 80 J	min. 35

**Typical Base Material Grades**

DIN: X 6 Cr 13	X 15 Cr 13	AISI: 405
X 6 Cr Al 13	X 22 CrNi 17	410
X 10 Cr 13 X	X 5 CrNi 13 4	420
8 Cr 17	X 8 CrTi 17	430
X 20 Cr 13	G-X 20 Cr 14	430 Ti
X 10 Cr Al 13	G-X 8 CrNi 13	431
X 10 Cr Al 7	G-X 30 CrSi 6	440
		502

**Features and Applications**

- Highly resistant steels, alloyed / unalloyed steels, armour steels, hard manganese steels, nonmagnetic steels, steels with 14% Mn hard-to-weld steels
- Joint welding of different metals with each other
- Resistance of weld metal to corrosion, wear, thermal shocks and working temperatures between -100 °C and +500 °C

**Welding Positions**

**Current Type**

D.C.(+)

**Operating Data**

Product Code	Diameter x Length (mm) / (inch)		Welding Current (A)	Weight g / 100 pcs
3010100893	2.50 x 250	3/32 x 10"	60 - 80	1280
3010100898	3.20 x 350	1/8 x 14"	80 - 100	3170
3010102108	4.00 x 350	5/32 x 14"	110 - 140	4900

**Approvals:** TSE, CE, GOST-R, SEPRO

**Standards**

TS EN ISO 3581-A	: E 18 8 Mn R 32
EN ISO 3581-A	: E 18 8 Mn R 32
AWS A5.4	: ~ E 307-16

**Chemical Composition of  
Weld Metal % (Typical)**

C	Si	Mn	Ni	Cr
0.11	1.0	4.5	8.5	19.0

**Mechanical Properties**

Yield Strength (N/mm <sup>2</sup> )	Tensile Strength (N/mm <sup>2</sup> )	Impact Strength (ISO-V/+20°C)	Elongation (L <sub>0</sub> =5d <sub>0</sub> ) (%)
min. 390	600-770	min. 47 J	min. 30

**Typical Base Material Grades**

DIN:	X 7 Cr 13	X 15 Cr 13	AISI:	405
	X 7 Cr Al 13	X 22 CrNi 17		410
	X 10 Cr 13	X 5 CrNi 134		420
	X 8 Cr 17	X 8 CrTi 17		430
	X 20 Cr 13	G-X 20 Cr 14		430 Ti
	X 10 Cr Al 7	G-X 8 CrNi 13		431
	X 10 Cr A 13	G-X 30 CrSi 6		440
				502

**Features and Applications**

- High resistant steels, alloyed / unalloyed steels, heat-resistant steels, Cr-stainless steels, steels including 14%Mn , hard-to-weld steels
- Joint welding and filler welding of difference metal with each other
- Electrode coating of rutile character
- Austenitic weld metal with resistance to thermal shocks
- Maintenance of toughness at temperatures down to -100°C
- Requirement of re-drying for min. 2 hours at the temperatures between 120°C and 200°C

**Welding Positions**

**Current Type**

D.C.(+) / A.C.

**Operating Data**

Product Code	Diameter x Length (mm) / (inch)		Welding Current (A)	Weight g / 100 pcs
3010100908	2.50 x 250	3/32 x 10"	60 - 80	1350
3010100913	3.20 x 350	1/8 x 14"	80 - 110	3320
3010100918	4.00 x 350	5/32 x 14"	110 - 140	4810

**Approvals:** TSE, CE, GOST-R, SEPRO

**Standards**

TS EN ISO 3581-A	: E 18 9 MnMo B 22
EN ISO 3581-A	: E 18 9 MnMo B 22
AWS A5.4	: E 307-15

**Chemical Composition of  
Weld Metal % (Typical)**

C	Si	Mn	Ni	Mo	Cr
0.08	0.6	4.0	9.5	1.0	19.0

**Mechanical Properties**

Yield Strength (N/mm <sup>2</sup> )	Tensile Strength (N/mm <sup>2</sup> )	Impact Strength (ISO-V/+20°C)	Elongation (L <sub>0</sub> =5d <sub>0</sub> ) (%)
min. 390	590-740	min. 78 J	min. 35

**Typical Base Material Grades**

DIN:	X 20 Cr 13	AISI:	403	440
	X 8 Cr 17		405	501
	X 22 CrNi 17		410	502
	X 5 CrNi 17		420	
	G-X 20 Cr 14		430	

**Features and Applications**

- Especially developed for the welding of armor steel
- Therefore this product using for hot work tool steels
- The welding of steels that are difficult to resource availability
- Stainless - Chromium, Chromium - Nickel steels and high strength steels welding

**Welding Positions**

**Current Type**

D.C.(+)

**Operating Data**

Product Code	Diameter x Length (mm) / (inch)		Welding Current (A)	Weight g / 100 pcs
3010100928	3.20 x 350	3/32 X 10"	60 - 80	3130
3010100933	4.00 x 350	1/8 X 14"	80 - 110	4800

**Approvals:** TSE, CE, GOST-R, SEPRO

**Standards**

TS EN ISO 3581-A	: E Z 18 9 MnMo R 53
EN ISO 3581-A	: E Z 18 9 MnMo R 53
AWS A5.4	: ~E307-26

**Chemical Composition of  
Weld Metal % (Typical)**

C	Si	Mn	Ni	Mo	Cr
0.07	0.9	5.6	8.5	0.75	19.0

**Mechanical Properties**

Yield Strength (N/mm <sup>2</sup> )	Tensile Strength (N/mm <sup>2</sup> )	Impact Strength (ISO-V/+20°C)	Elongation (L <sub>0</sub> =5d <sub>0</sub> ) (%)
min. 400	590-700	min. 47 J	min. 35

**Typical Base Material Grades**

DIN:	X 6 Cr 13	X 15 Cr 13	AISI:	405
	X 6 Cr Al 13	X 22 CrNi 17		410
	X 10 Cr 13	X 5 CrNi 13 4		420
	X 8 Cr 17	X 8 CrTi 17		430
	X 20 Cr 13	G-X 20 Cr 14		430Ti
	X 10 Cr Al 7	G-X 8 CrNi 13		431
	X 10 Cr A 13	G-X 30 CrSi 6		440
				502

**Features and Applications**

- Welding of high resistant alloyed / unalloyed steels, heat-resistant steels / stainless steels, steels with 14% Mn, for welding problematic steels
- Joint and filler welding of different metals
- Rutile coated electrode, weld metal is austenitic, resistant to thermal shocks, keeps its toughness down to -100°C
- Requirement of re-drying for min. 2 hours at the temperatures between 120°C and 200°C

**Welding Positions**

**Current Type**

D.C.(+)

**Operating Data**

Product Code	Diameter x Length (mm) / (inch)		Welding Current (A)	Weight g / 100 pcs
3010100943	3.20 x 350	1/8 x 14"	110 - 150	4900
3010100948	4.00 x 350	5/32 x 14"	140 - 180	7830

**Approvals:** TSE, CE, GOST-R, SEPRO

**Standards**

TS EN ISO 3581-A	: E 19 9 L R 32
EN ISO 3581-A	: E 19 9 L R 32
AWS A5.4	: E 308 L- 16

**Chemical Composition of  
Weld Metal % (Typical)**

C	Si	Mn	Ni	Cr
0.03	0.8	0.9	10.5	20.0

**Mechanical Properties**

Yield Strength (N/mm <sup>2</sup> )	Tensile Strength (N/mm <sup>2</sup> )	Impact Strength (ISO-V/+20°C)	Elongation (L <sub>0</sub> =5d <sub>0</sub> ) (%)
min. 355	520 - 660	min. 47 J	min. 35

**Typical Base Material Grades**

- X2CrNi 19 11, X5CrNi 18 10, X6CrNiTi 18 10, X6CrNiNb 18 10, X2CrNiN 18 10, X10CrNiNb 18 10, X12CrNi 18 8, 304 L, 304, 304 LN, 321, 347, 302

**Features and Applications**

- Rutile-coated low-carbon electrode for use in chemical, petrochemical and food industries where similar steel types, including higher carbon grades as well as ferritic 13% -Cr steels are welded. Resistant to corrosion and cracks. Working temperatures up to +350°C
- Requirement of Re-drying for min. 2 hours at the temperatures between 120°C and 200°C

**Welding Positions**

**Current Type**

D.C.(+)/ A.C

**Operating Data**

Product Code	Diameter x Length (mm) / (inch)		Welding Current (A)	Weight g / 100 pcs
3010100963	2.50 x 250	3/32 x 10"	50 - 90	1500
3010100968	3.20 x 300	1/8 x 12"	80 - 120	2930
3010100973	3.20 x 350	1/8 x 14"	80 - 120	3510
3010100978	4.00 x 350	5/32 x 14"	110 - 160	5100

**Approvals:** TSE, CE, BV, ABS, GOST-R, SEPRO

**Standards**

TS EN ISO 3581-A	: E 19 9 L R 32
EN ISO 3581-A	: E 19 9 L R 32
AWS A5.4	: E 308 L- 17

**Chemical Composition of  
Weld Metal % (Typical)**

C	Si	Mn	Ni	Cr
0.03	0.8	0.9	10.5	20.0

**Mechanical Properties**

Yield Strength (N/mm <sup>2</sup> )	Tensile Strength (N/mm <sup>2</sup> )	Impact Strength (ISO-V/+20°C)	Elongation (L <sub>0</sub> =5d <sub>0</sub> ) (%)
min. 355	520 - 660	min. 47 J	min. 35

**Typical Base Material Grades**

- X2CrNi 19 11, X5CrNi 18 10, X6CrNiTi 18 10, X6CrNiNb 18 10, X6CrNiNb 18 10, X10CrNiNb 18 10, X12CrNi 18 8, 304 L, 304, 304 LN, 321, 347, 302

**Features and Applications**

- Rutile-coated low-carbon electrode for use in chemical, petrochemical and food industries where similar steel types, including higher carbon grades as well as ferritic 13% - Cr steels are welded.
- Resistant to corrosion and cracks.
- Working temperatures up to +350°C
- Requirement of Re-drying for min. 2 hours at the temperatures between 120°C and 200°C

**Welding Positions**

**Current Type**

D.C.(+) / A.C

**Operating Data**

Product Code	Diameter x Length (mm) / (inch)		Welding Current (A)	Weight g / 100 pcs
3010100993	2.50 x 250	3/32 x 10"	50 - 90	1510
3010100998	3.20 x 350	1/8 x 14"	80 - 120	3510
3010101003	4.00 x 350	5/32 x 14"	110-160	4930

**Approvals:** TSE, CE, GOST-R, SEPRO

**Standards**

TS EN ISO 3581-A	: E 19 9 H R 32
EN ISO 3581-A	: E 19 9 H R 32
AWS A5.4	: E 308 H- 16

**Chemical Composition of  
Weld Metal % (Typical)**

C	Si	Mn	Ni	Cr
0.07	0.7	0.8	10.4	19.0

**Mechanical Properties**

Yield Strength (N/mm <sup>2</sup> )	Tensile Strength (N/mm <sup>2</sup> )	Impact Strength (ISO-V/+20°C)	Elongation (L <sub>0</sub> =5d <sub>0</sub> ) (%)
min. 355	550 - 650	min. 47 J	min. 35

**Typical Base Material Grades**

- DIN; X5CrNi18 -10, X6CrNiTi18-10, X6CrNiNb18-10, X8CrNiTi18-10, X7CrNi18-9
- AISI; 304, 304H, 321, 321H, 347, 347H

**Features and Applications**

- Electrode with rutile coating on alloyed core-wire
- Applicability in welding Cr-Ni alloyed austenitic high - temperatures steel
- Usability in welding at all positions except for vertical downward position
- Applicability in joint-welding and surfacing of heat-resisting similar-type steels and steel casting
- Serviceability at temperatures of values up to 700°C
- Resistance to fracture and corrosion
- Creep resistance at high temperatures being higher than that of the electrode GeKa ELOX R 308 L

**Welding Positions**

**Current Type**

D.C.(+) / A.C

**Operating Data**

Product Code	Diameter x Length (mm) / (inch)		Welding Current (A)	Weight g / 100 pcs
3010101008	2.50 x 250	3/32 x 10"	50 - 80	1490
3010101013	3.20 x 350	1/8 x 14"	80 - 110	3430
3010101018	4.00 x 350	5/32 x 14"	110-140	5060

**Approvals:** TSE, CE, GOST-R, SEPRO

**Standards**

TS EN ISO 3581-A	: E 19 9 L B 22
EN ISO 3581-A	: E 19 9 L B 22
AWS A5.4	: E 308 L-15

**Chemical Composition of  
Weld Metal % (Typical)**

C	Si	Mn	Ni	Cr
0.02	0.45	1.2	10.3	19.7

**Mechanical Properties**

Yield Strength (N/mm <sup>2</sup> )	Tensile Strength (N/mm <sup>2</sup> )	Impact Strength (ISO-V/+20°C)	Elongation (L <sub>0</sub> =5d <sub>0</sub> ) (%)
min. 370	520 - 660	90 J	min. 40

**Typical Base Material Grades**

- X2CrNi 19 11, X5CrNi 18 10, X6CrNiTi 18 10, X6CrNiNb 18 10, X 10 CrNiNb 18 10, X2CrNiN 18 10, X12CrNi 18 8, 304L, 304, 304 LN, 321, 347, 302, 320 B 8 C & D

**Features and Applications**

- Low carbon alloyed core wire austenitic electrode with basic coating for use in all industries where similar steel types, including higher carbon grades as well as ferritic 13% -Cr steels are welded.
- High ductility of the weld metal, therefore preferably used for welding heavy sections.
- Very good out-of-position weldability.
- Good low-temperature ductility down to -196°C.
- Resistant to intergranular corrosion up to 350°C.
- Weld metal does not require preheating or postweld heat treatment.

**Welding Positions**

**Current Type**

D.C.(+)

**Operating Data**

Product Code	Diameter x Length (mm) / (inch)		Welding Current (A)	Weight g / 100 pcs
3010101023	2.50 x 250	3/32 x 10"	50-80	1510
3010101028	3.20 x 350	1/8 x 14"	80-110	3330
3010101033	4.00 x 350	5/32 x 14"	110-140	4760

**Approvals:** TSE, CE, GOST-R, SEPRO



**Standards**

TS EN ISO 3581-A	: E 19 9 H B 22
EN ISO 3581-A	: E 19 9 H B 22
AWS A5.4	: E 308 H-15

**Chemical Composition of  
Weld Metal % (Typical)**

C	Si	Mn	Ni	Cr
0.05	0.6	1.4	10.5	19.0

**Mechanical Properties**

Yield Strength (N/mm <sup>2</sup> )	Tensile Strength (N/mm <sup>2</sup> )	Impact Strength (ISO-V/+20°C)	Elongation (L <sub>0</sub> =5d <sub>0</sub> ) (%)
min. 350	min. 550	min. 47 J	min. 30

**Typical Base Material Grades**

- 301,302,304, 304H, 305,321

**Features and Applications**

- A basic coating electrodes are used for welding type 304H and similar applications where creep strength is required
- Electrodes are the same as E308 , except for carbon content that has been restricted in the range of 0.04 to 0.08
- It provides higher tensile and creep strength has at elevated temperatures
- Weld metal ferrite content is normally targeted for 5 FN to minimize effect of sigma embrittlement in high temperature service

**Welding Positions**

**Current Type**

D.C.(+)

**Operating Data**

Product Code	Diameter x Length (mm) / (inch)		Welding Current (A)	Weight g / 100 pcs
3010101598	2.50 x 250	3/32 x 10"	60 - 90	1500
3010101603	3.20 x 350	1/8 x 14"	100 - 130	3300
3010101608	4.00 x 350	5/32 x 14"	100 - 160	4750

**Approvals: CE, SEPRO**

**Standards**

TS EN ISO 3581-B	: ES308LMo-16
EN ISO 3581-B	: ES308LMo-16
AWS A5.4	: E308LMo-16

**Chemical Composition of  
Weld Metal % (Typical)**

C	Mo	Ni	Cr
0.03	2.5	9.5	18.0

**Mechanical Properties**

Yield Strength (N/mm <sup>2</sup> )	Tensile Strength (N/mm <sup>2</sup> )	Impact Strength (ISO-V/+20°C)	Elongation (L <sub>0</sub> =5d <sub>0</sub> ) (%)
min. 450	540 - 700	47 J	min. 35

**Typical Base Material Grades**

- ASTM A351-Gr. CF3M steel casting.

**Features and Applications**

- A rutile electrode for welding of dissimilar steels
- The general purpose electrode for repair welding
- It has easy slag removal and smooth appearance in filled welding

**Welding Positions**

**Current Type**

D.C.(+) / A.C.

**Operating Data**

Product Code	Diameter x Length (mm) / (inch)		Welding Current (A)	Weight g / 100 pcs
3010100988	3.20 x 350	1/8 x 14"	80 - 120	3510

**Approvals:** CE, GOST-R, SEPRO

**Standards**

TS EN ISO 3581-A	: E 19 9 R 53
EN ISO 3581-A	: E 19 9 R 53
AWS A5.4	: E308-26

**Chemical Composition of  
Weld Metal % (Typical)**

C	Si	Mn	Ni	Cr
0.07	0.8	1.0	9.0	18.0

**Mechanical Properties**

Yield Strength (N/mm <sup>2</sup> )	Tensile Strength (N/mm <sup>2</sup> )	Impact Strength (ISO-V/+20°C)	Elongation (L <sub>0</sub> =5d <sub>0</sub> ) (%)
min. 410	570 - 710	min. 55 J	min. 30

**Typical Base Material Grades**

- X2CrNi 1911, X5CrNi 1911, X5CrNi 18 8, X12CrNi 17 7, X12CrNi 18 8, G-X10CrNi 18 8, G-X12CrNi 18 8,  
 AISI: 304 L, 304, 302, 301, 308

**Features and Applications**

- Applicability in joint- and surface-welding operations of 18/8 Cr-Ni steels, high-strength tempered steels, stainless steels and carbon steels
- Welding efficiency of approximately 150%
- Resistance to high current
- Requirement of re-drying for min. 2 hours at the temperatures between 120°C and 200°C

**Welding Positions**

**Current Type**

D.C.(+) / A.C.

**Operating Data**

Product Code	Diameter x Length (mm) / (inch)		Welding Current (A)	Weight g / 100 pcs
3010101038	2.50 x 350	3/32 x 14"	80 - 120	2820
3010101043	3.20 x 350	1/8 x 14"	110 - 160	5700
3010101048	4.00 x 350	5/32 x 14"	150 - 190	7680

**Approvals:** TSE, CE, GOST-R, SEPRO

**Standards**

TS EN ISO 3581-A	: E 23 12 L R 32
EN ISO 3581-A	: E 23 12 L R 32
AWS A5.4	: E309L-16

**Chemical Composition of  
Weld Metal % (Typical)**

C	Si	Mn	Ni	Cr
0.03	0.8	0.8	12.6	23.0

**Mechanical Properties**

Yield Strength (N/mm <sup>2</sup> )	Tensile Strength (N/mm <sup>2</sup> )	Impact Strength (ISO-V/+20°C)	Elongation (L <sub>0</sub> =5d <sub>0</sub> ) (%)
min. 440	540 - 720	min.47 J	min. 30

**Typical Base Material Grades**

- High-strength unalloyed and heat-treatable steels, ferritic Cr and austenitic CrNi steels, austenitic Mn steels.
- Unalloyed tempered steels, tool steels, hard manganese steels, ferritic chromium steels, austenitic nickel chromium steels, hard-to- weld steels.

**Features and Applications**

- Similar-type austenitic stainless steels, dissimilar metals, buffer layers on mild and low-alloy steels prior to build up or overlaying with any stainless electrodes, joining of corrosion resistant stainless steel with mild or low alloy steels, clad steels
- Good crack resistance with hard to weld steels
- The weld metal is content to high ferrite %
- Requirement of re-drying for min. 2 hours at the temperatures between 120°C and 200°C

**Welding Positions**

**Current Type**

D.C.(+) / A.C.

**Operating Data**

Product Code	Diameter x Length (mm) / (inch)		Welding Current (A)	Weight g / 100 pcs
3010101058	2.00 x 250	5/64 x 10"	50-85	950
3010101063	2.50 x 250	3/32 x 10"	60-90	1570
3010101073	3.20 x 350	1/8 x 14"	80-120	3610
3010101078	4.00 x 350	5/32 x 14"	100-160	5050

**Approvals:** TSE, CE, BV, ABS, GOST-R, SEPRO, RCB, DNV-GL

**Standards**

TS EN ISO 3581-B	: ES309-16
EN ISO 3581-B	: ES309-16
AWS A5.4	: E 309 H-16

**Chemical Composition of  
Weld Metal % (Typical)**

C	Si	Mn	Ni	Cr
0.06	0.8	0.8	12.0	23.0

**Mechanical Properties**

Yield Strength (N/mm <sup>2</sup> )	Tensile Strength (N/mm <sup>2</sup> )	Impact Strength (ISO-V/+20°C)	Elongation (L <sub>0</sub> =5d <sub>0</sub> ) (%)
min. 440	550 - 720	min.47 J	min. 30

**Typical Base Material Grades**

- Alloyed and unalloyed steels, AISI 309 Type Steel, Tool Steels, Austenitic Cr-Ni and Mn steels

**Features and Applications**

- Electrode with rutile coating on alloyed core-wire
- Applicability in welding similar/dissimilar type austenitic stainless steels, high-strength unalloyed and heat treatable steels, ferritic Cr and austenitic CrNi steels, austenitic Mn steels
- It provides higher tensile and creep strength at elevated temperatures according to ELOX R 309 L
- Usability in welding at all positions except for vertical downward position

**Welding Positions**

**Current Type**

D.C.(+) / A.C.

**Operating Data**

Product Code	Diameter x Length (mm) / (inch)		Welding Current (A)	Weight g / 100 pcs
3010102197	2.50 x 250	3/32 x 10"	50-85	1550
3010102198	3.20 x 350	1/8 x 14"	80-120	3600

**Approvals:** SEPRO

**Standards**

TS EN ISO 3581-A	: E 23 12 L R 32
EN ISO 3581-A	: E 23 12 L R 32
AWS A5.4	: E309L-17

**Chemical Composition of  
Weld Metal % (Typical)**

C	Si	Mn	Ni	Cr
0.03	0.8	0.8	12.6	23.0

**Mechanical Properties**

Yield Strength (N/mm <sup>2</sup> )	Tensile Strength (N/mm <sup>2</sup> )	Impact Strength (ISO-V/+20°C)	Elongation (L <sub>0</sub> =5d <sub>0</sub> ) (%)
min. 440	540 - 720	min.47 J	min. 30

**Typical Base Material Grades**

- High-strength unalloyed and heat-treatable steels, ferritic Cr and austenitic CrNi steels, austenitic Mn steels
- Unalloyed tempered steels, tool steels, hard manganese steels, hard-to-weld steels

**Features and Applications**

- Rutile-coated low-carbon electrode for use in high-strength unalloyed and heat treatable steels, ferritic Cr and austenitic CrNi steels, austenitic Mn steels
- Similar-type austenitic stainless steels, dissimilar metals, buffer layers on mild and low-alloyed steels prior to build up or overlaying with any stainless electrodes, joining of corrosion resistant stainless steel with mild or low alloy steels, clad steels
- Good crack resistance with hard-to-weld steels
- The weld metal is content to high ferrite %
- Requirement of re-drying for minimum 2 hours at the temperatures between 120°C and 200°C

**Welding Positions**

**Current Type**

D.C.(+) / A.C.

**Operating Data**

Product Code	Diameter x Length (mm) / (inch)		Welding Current (A)	Weight g / 100 pcs
3010101083	2.50 x 250	3/32 x 10"	60-90	1550
3010101088	3.20 x 350	1/8 x 14"	80-120	3640
3010101093	4.00 x 350	5/32 x 14"	100-160	5320

**Approvals:** TSE, CE, GOST-R, SEPRO

**Standards**

TS EN ISO 3581-A	: E 23 12 2 L R 32
EN ISO 3581-A	: E 23 12 2 L R 32
AWS A5.4	: E 309LMo-16

**Chemical Composition of  
Weld Metal % (Typical)**

C	Si	Mn	Mo	Ni	Cr
<0.03	0.7	0.8	2.8	13.0	23.0

**Mechanical Properties**

Yield Strength (N/mm <sup>2</sup> )	Tensile Strength (N/mm <sup>2</sup> )	Impact Strength (ISO-V/+20°C)	Elongation (L <sub>0</sub> =5d <sub>0</sub> ) (%)
530	700	min.55 J	35

**Typical Base Material Grades**

- High strength unalloyed and alloyed steels, heat resistant steels, ferritic and austenitic steels

**Features and Applications**

- Welding of higher strength unalloyed and alloyed steels
- Welding of heat resistant steels
- Welding of high temperature pressure vessels, similar type of ferritic and austenitic steels
- Welding of corrosion and heat resistant steels, build-up or overlaying, buffer layers applications
- Weld metal contains higher amount of ferrite and has higher resistance to cracking
- Requirement of Re-drying for min. 2 hours at the temperatures between 120°C and 200°C

**Welding Positions**

**Current Type**

D.C.(+) / A.C.

**Operating Data**

Product Code	Diameter x Length		Welding Current (A)	Weight g / 100 pcs
	(mm)	(inch)		
3010101098	2.50 x 250	3/32 x 10"	60-90	1570
3010101103	3.20 x 350	1/8 x 14"	80-120	3640
3010101108	4.00 x 350	5/32 x 14"	100-160	5050

**Approvals:** TSE, CE, GOST-R, SEPRO

**Standards**

TS EN ISO 3581-A	: E 23 12 2 L R 32
EN ISO 3581-A	: E 23 12 2 L R 32
AWS A5.4	: E 309LMo-17

**Chemical Composition of  
Weld Metal % (Typical)**

C	Si	Mn	Mo	Ni	Cr
<0.03	0.7	0.8	2.8	13.0	23.0

**Mechanical Properties**

Yield Strength (N/mm <sup>2</sup> )	Tensile Strength (N/mm <sup>2</sup> )	Impact Strength (ISO-V/+20°C)	Elongation (L <sub>0</sub> =5d <sub>0</sub> ) (%)
min. 490	620-750	min.47 J	min. 30

**Typical Base Material Grades**

- Uses in high strength unalloyed and heat-treatable steels, ferritic / austenitic steels, austenitic Mn steels.

**Features and Applications**

- Similar type austenitic stainless steels, dissimilar metals , buffer layers on mild and low-alloy steels prior ta build up or overlaying with any stainless steels electrode
- Joining of corrosion-resistant stainless steel with mild or low- alloy steels, clad steels
- The weld metal is content to high ferrite %
- Good cracking resistance with problematic steels
- Requirement of Re-drying for min. 2 hours at the temperatures between 120°C and 200°C

**Welding Positions**

**Current Type**

D.C.(+) / A.C.

**Operating Data**

Product Code	Diameter x Length		Welding Current (A)	Weight g / 100 pcs
	(mm)	(inch)		
3010101113	2.50 x 250	3/32 x 10"	60-90	1570
3010101118	3.20 x 350	1/8 x 14"	80-120	3640
3010101123	4.00 x 350	5/32 x 14"	100-160	5050

**Approvals:** TSE, CE, GOST-R, SEPRO



**Standards**

TS EN ISO 3581-A	: E 22 12 B 22
EN ISO 3581-A	: E 22 12 B 22
AWS A5.4	: E 309 -15

**Chemical Composition of  
Weld Metal % (Typical)**

C	Si	Mn	Ni	Cr
0.085	0.9	1.8	12.5	22.5

**Mechanical Properties**

Yield Strength (N/mm <sup>2</sup> )	Tensile Strength (N/mm <sup>2</sup> )	Impact Strength (ISO-V/+20°C)	Elongation (L <sub>0</sub> =5d <sub>0</sub> ) (%)
min. 360	550-650	min.47 J	min.25

**Typical Base Material Grades**

- X15CrNiSi20 12, X10CrAl7, X10CrAl13, X10CrAl18, G-X40CrNiSi22, 9G-X40CrSi17, G-X30CrSi6, AISI 305, ASTM; A297HF

**Features and Applications**

- Basic-coated alloyed core wire electrode for welding analogous, heat resistant rolled, forged and cast steels as well as heat resistant ferritic CrSiAl steels
- For weld joints exposed to reducing, sulphurous gases, the final layer has to be deposited by means of this electrode
- In annealing plants, hardening plants, steam boiler construction, the crude oil industry and the ceramics industry
- Scaling resistant up to 1000°C

**Welding Positions**

**Current Type**

D.C.(+)

**Operating Data**

Product Code	Diameter x Length (mm) / (inch)		Welding Current (A)	Weight g / 100 pcs
3010101128	2.50 x 250	3/32 x 10"	60 - 80	1500
3010101133	3.20 x 350	1/8 x 14"	80 - 110	3250
3010101138	4.00 x 350	5/32 x 14"	110-140	4730

**Approvals:** TSE, CE, GOST-R, SEPRO

**Standards**

TS EN ISO 3581-A	: E 25 20 R 32
EN ISO 3581-A	: E 25 20 R 32
AWS A5.4	: ~E 310-16

**Chemical Composition of  
Weld Metal % (Typical)**

C	Si	Mn	Ni	Cr
0.12	0.9	2.5	20	26.0

**Mechanical Properties**

Yield Strength (N/mm <sup>2</sup> )	Tensile Strength (N/mm <sup>2</sup> )	Impact Strength (ISO-V/+20°C)	Elongation (L <sub>0</sub> =5d <sub>0</sub> ) (%)
min. 355	560-690	min.47 J	min. 25

**Typical Base Material Grades**

- Furnace, boilers, pipes made of Cr-Ni and Cr-Si-Al alloyed steels.
- X15CrNiSi 25-20, X15CrNiSi 25-21, X15CrNiSi 20-12, G-X40CrNi25, GX40CrNiSi229, X10CrAl, X10CrAl24, GX40CrSi1, AISI 305, 310, 304

**Features and Applications**

- Weld metal is resistant to working temperatures up to +1200°C
- Used with alternative current also
- Requirement of Re-drying for min. 2 hours at the temperatures between 120°C and 200°C

**Welding Positions**

**Current Type**

D.C.(+)/ A.C.

**Operating Data**

Product Code	Diameter x Length (mm) / (inch)		Welding Current (A)	Weight g / 100 pcs
3010101158	2.50 x 250	3/32 x 10"	50 - 80	1410
3010101163	3.20 x 300	1/8 x 1 2"	80 - 110	2930
3010101168	3.20 x 350	1/8 x 1 4"	80 - 110	3460
3010101173	4.00 x 350	5/32 x 1 4"	110 - 140	5300

**Approvals:** TSE, CE, GOST-R, SEPRO

### Standards

TS EN ISO 3581-A	: ES 310 Mo-16
EN ISO 3581-A	: ES 310 Mo-16
AWS A5.4	: E 310 Mo-16

### Chemical Composition of Weld Metal % (Typical)

C	Cr	Ni	Mo
0.08	25.0	21.0	2.8

### Mechanical Properties

Tensile Strength (N/mm <sup>2</sup> )	Elongation (L <sub>0</sub> =5d <sub>0</sub> ) (%)
min. 550	min. 30

### Typical Base Material Grades

- For austenitic steels, Cr-Mo Steels, coated stainless steels and type AISI 316, 316L and 317 clad steels.

### Features and Applications

- Rutile-basic coated electrode
- The addition of Mo is improved high temperature creep properties
- The weld deposit is full austenitic and corrosion resistant

### Welding Positions



### Current Type

D.C.(+)

### Operating Data

Product Code	Diameter x Length (mm) / (inch)		Welding Current (A)	Weight g / 100 pcs
3010101178	3.20 x 350	1/8 x 14"	80 - 110	3510
3010101183	4.00 x 350	5/32 x 14"	110 - 140	5140

**Approvals:** SEPRO

**Standards**

TS EN ISO 3581-A	: E 25 20 B 22
EN ISO 3581-A	: E 25 20 B 22
AWS A5.4	: ~E 310-15

**Chemical Composition of  
Weld Metal % (Typical)**

C	Si	Mn	Ni	Cr
0.12	0.9	3.0	20.5	25.0

**Mechanical Properties**

Yield Strength (N/mm <sup>2</sup> )	Tensile Strength (N/mm <sup>2</sup> )	Impact Strength (ISO-V/+20°C)	Elongation (L <sub>0</sub> =5d <sub>0</sub> ) (%)
min. 355	560-690	100 J	min. 25

**Typical Base Material Grades**

- X15CrNiSi 25 20, X12CrNi 25 21, X15CrNiSi 20 12, G-X 15CrNi 25 20, G-X 40CrNi 25 21, G-X40CrNiSi22 9, X10CrAl 18, X10CrAl 24, G-X40CrSi 17, AISI 305, 310, 314.

**Features and Applications**

- Austenitic CrNi steels, ferritic CrNiAl alloyed steels, heat-resisting rolled, forged and cast steels used in ceramic, petrochemical industries and furnace, boilers, chimney applications
- Weld metal is resistant to working temperature - 196°C up to +1200°C

**Welding Positions**

**Current Type**

D.C.(+)

**Operating Data**

Product Code	Diameter x Length (mm) / (inch)		Welding Current (A)	Weight g / 100 pcs
3010101188	2.50 x 250	3/32 x 10"	50 - 80	1440
3010101193	3.20 x 300	1/8 x 1 2"	80 - 110	2710
3010101198	3.20 x 350	1/8 x 1 4"	80 - 110	3120
3010101203	4.00 x 350	5/32 x 1 4"	110 - 140	4750

**Approvals:** TSE, CE, GOST-R, SEPRO

**Standards**

TS EN ISO 3581-A	: E 29 9 R 12
EN ISO 3581-A	: E 29 9 R 12
AWS A5.4	: ~E 312-16

**Chemical Composition of  
Weld Metal % (Typical)**

C	Si	Mn	Ni	Cr
0.12	1.0	0.8	10.5	30.0

**Mechanical Properties**

Yield Strength (N/mm <sup>2</sup> )	Tensile Strength (N/mm <sup>2</sup> )	Impact Strength (ISO-V/+20°C)	Elongation (L <sub>0</sub> =5d <sub>0</sub> ) (%)
min. 490	700-830	min. 24 J	min. 20

**Typical Base Material Grades**

DIN:		AISI:	
X7Cr13	G-X7Cr13	403	
X7CrAl13	G-X20Cr14	405	
X10CrAl13	G-X10CrMo13	410	
X8Cr17	G-X8CrNi13	420	
X20Cr13		430	
X15Cr13		430Ti	
X22CrNi 17		431	
X15CrNi13 4		446	
X8CrTi17			

**Features and Applications**

- Alloyed-unalloyed high-resistant steels, Cr and Mn steels, joint welding of tool steels and different steels and repair welding of sprockets and wheelshaft
- Weld metal is resistant to corosions, cracks and rust
- Requirement of re-drying for min. 2 hours at the temperatures between 120°C and 200°C

**Welding Positions**

**Current Type**

D.C.(+) / A.C.

**Operating Data**

Product Code	Diameter x Length (mm) / (inch)		Welding Current (A)	Weight g / 100 pcs
3010101208	2.50 x 250	3/32 x 10"	50 - 80	1260
3010101213	3.20 x 300	1/8 x 1 2"	80 - 110	2470
3010101218	3.20 x 350	1/8 x 1 4"	80 - 110	2890
3010101223	4.00 x 350	5/32 x 1 4"	110 - 160	4470

**Approvals:** TSE, CE, ABS, BV, GOST-R, SEPRO, RCB

**Standards**

TS EN ISO 3581-A	: E 19 12 3 L R 32
EN ISO 3581-A	: E 19 12 3 L R 32
AWS A5.4	: E316L-16

**Chemical Composition of  
Weld Metal % (Typical)**

C	Si	Mn	Mo	Ni	Cr
0.03	0.8	0.9	2.6	11.5	19.0

**Mechanical Properties**

Yield Strength (N/mm <sup>2</sup> )	Tensile Strength (N/mm <sup>2</sup> )	Impact Strength (ISO-V/+20°C)	Elongation (L <sub>0</sub> =5d <sub>0</sub> ) (%)
min. 355	540-670	min. 47 J	min. 30

**Typical Base Material Grades**

- EN: X10CrNiMoNb 18 12, X2CrNiMo 18 14 3, X5CrNiMo 17 13 3, X2CrNiMo 17 13 2, X2CrNiMoN 17 12 2, X5CrNiMo 17 12 2, X5CrNiMoTi 17 12 2, X6CrNiMoNb 17 12 2, X2CrNiMoN 17 13 3.
- AISI: 316Cb, 316, 316L, 316Ti

**Features and Applications**

- Tanks, pipes and equipments made of Cr-Ni-Mo low-carbon steels which are used in food, textile, chemical and paint industries
- Weld metal is resistant to acid, corrosion
- Serviceability at temperatures up to 400°C
- Requirement of Re-drying for min. 2 hours at the temperatures between 120°C and 200°C

**Welding Positions**

**Current Type**

D.C.(+) / A.C.

**Operating Data**

Product Code	Diameter x Length (mm) / (inch)		Welding Current (A)	Weight g / 100 pcs
3010101243	2.00 x 250	5/64 x 10"	40-70	950
3010101248	2.50 x 250	3/32 x 10"	50-90	1500
3010101258	3.20 x 350	1/8 x 14"	80-120	3480
3010101263	4.00 x 350	5/32 x 14"	110-160	5130

**Approvals:** TSE, BV, CE, ABS, GOST-R, SEPRO, RCB, DNV-GL

**Standards**

TS EN ISO 3581-A	: E 19 12 3 L R 32
EN ISO 3581-A	: E 19 12 3 L R 32
AWS A5.4	: E316L-17

**Chemical Composition of  
Weld Metal % (Typical)**

C	Si	Mn	Mo	Ni	Cr
0.03	0.8	0.9	2.6	11.5	19.0

**Mechanical Properties**

Yield Strength (N/mm <sup>2</sup> )	Tensile Strength (N/mm <sup>2</sup> )	Impact Strength (ISO-V/+20°C)	Elongation (L <sub>0</sub> =5d <sub>0</sub> ) (%)
min. 355	540-670	min. 47 J	min. 30

**Typical Base Material Grades**

- EN: X10CrNiMoNb 18 12, X2CrNiMo 18 14 3, X5CrNiMo 17 13 3, X2CrNiMo 17 13 2, X2CrNiMoN 17 12 2, X5CrNiMo 17 12 2, X5CrNiMoTi 17 12 2, X6CrNiMoNb 17 12 2, X2CrNiMoN 17 13 3.
- AISI: 316Cb, 316, 316L, 316Ti

**Features and Applications**

- Rutile-coated low-carbon electrode for use in tanks, pipes and equipments made of Cr-Ni-Mo low-carbon steels which are used in food, textile, chemical and paint industries
- Weld metal is resistant to acid, corrosion
- Serviceability at temperatures up to 400°C
- Requirement of Re-drying for min. 2 hours at the temperatures between 120°C and 200°C

**Welding Positions**

**Current Type**

D.C.(+) / A.C.

**Operating Data**

Product Code	Diameter x Length (mm) / (inch)		Welding Current (A)	Weight g / 100 pcs
3010101268	2.50 x 250	3/32 X 10"	50-90	1480
3010101273	3.20 x 350	1/8 X 14"	80-120	3470
3010101278	4.00 x 350	5/32 X 14"	110-160	5030

**Approvals:** TSE, CE, GOST-R, SEPRO

**Standards**

TS EN ISO 3581-A	: E 19 12 3 L B 22
EN ISO 3581-A	: E 19 12 3 L B 22
AWS A5.4	: E 316 L-15

**Chemical Composition of  
Weld Metal % (Typical)**

C	Si	Mn	Mo	Ni	Cr
0.03	0.45	1.35	2.75	11.5	18.9

**Mechanical Properties**

Yield Strength (N/mm <sup>2</sup> )	Tensile Strength (N/mm <sup>2</sup> )	Impact Strength (ISO-V/+20°C)	Elongation (L <sub>0</sub> =5d <sub>0</sub> ) (%)
min. 360	550-700	min. 55 J	min. 35

**Typical Base Material Grades**

- EN: X10CrNiMoNb 18 12, X2CrNiMo 18 14 3, X5CrNiMo 17 13 3, X2CrNiMo 17 13 2, X2CrNiMoN 17 12 2, X5CrNiMo 17 12 2, X5CrNiMoTi 17 12 2, X6CrNiMoNb 17 12 2, X2CrNiMoN 17 13 3.
- AISI: 316Cb, 316, 316L, 316Ti

**Features and Applications**

- Low-carbon alloyed-core wire austenitic electrode with basic coating for use in all industries where analogous steels, including higher carbon grades and ferritic 13% Cr types, are welded. High ductility of weld metal, therefore preferably used for welding of heavy sections. Very good out-of-position weldability. Good low-temperature ductility down to -196°C. Resistance to intergranular corrosion up to 400°C.
- No requirement of preheating or postweld heat treatment of weld metal

**Welding Positions**

**Current Type**

D.C.(+)

**Operating Data**

Product Code	Diameter x Length (mm) / (inch)		Welding Current (A)	Weight g / 100 pcs
3010101283	2.50 x 250	3/32 x 10"	60 - 80	1440
3010101288	3.20 x 350	1/8 x 14"	80 - 110	3480
3010101293	4.00 x 350	5/32 x 14"	110 - 140	5080

**Approvals:** TSE, CE, GOST-R, SEPRO



**Standards**

TS EN ISO 3581-A	: E 19 12 2 R 53
EN ISO 3581-A	: E 19 12 2 R 53
AWS A5.4	: E316-26

**Chemical Composition of  
Weld Metal % (Typical)**

C	Si	Mn	Mo	Ni	Cr
0.07	0.9	1.0	2.7	11.0	18.5

**Mechanical Properties**

Yield Strength (N/mm <sup>2</sup> )	Tensile Strength (N/mm <sup>2</sup> )	Impact Strength (ISO-V/+20°C)	Elongation (L <sub>0</sub> =5d <sub>0</sub> ) (%)
min. 410	640-740	min. 55 J	min. 30

**Typical Base Material Grades**

- EN: X5CrNiMo 17 13 3, X10CrNiMo 18 10, X6CrNiMoTi 17 12 2, X5CrNiMo 17 12 2, G-X10CrNiMo 18 10,
- AISI: 316, 316Ti, 317

**Features and Applications**

- Used for welding of Cr-Ni-Mo alloyed steels, joint of stainless steel to carbon steels and used for surfacing of stainless steel on carbon steels
- The efficiency of weld metal is approx. 150%
- It is synthetic electrode and is resistant to high current
- Requirement of re-drying for min. 2 hours at the temperatures between 120°C and 200°C

**Welding Positions**

**Current Type**

D.C.(+) / A.C.

**Operating Data**

Product Code	Diameter x Length (mm) / (inch)		Welding Current (A)	Weight g / 100 pcs
3010101298	2.50 x 350	3/32 x 14"	90 - 120	3310
3010101303	3.20 x 350	1/8 x 14"	110 - 160	5480
3010101308	4.00 x 350	5/32 x 14"	150 - 190	8080
3010101313	5.00 x 350	3/16 x 14"	180 - 220	11400

**Approvals:** TSE, CE, SEPRO

**Standards**

TS EN ISO 3581-A	: E Z 19 13 4 L R 12
EN ISO 3581-A	: E Z 19 13 4 L R 12
AWS A5.4	: E317L-16

**Chemical Composition of  
Weld Metal % (Typical)**

C	Si	Mn	Mo	Ni	Cr
<0.04	0.8	0.9	3.2	12.5	18.7

**Mechanical Properties**

Yield Strength (N/mm <sup>2</sup> )	Tensile Strength (N/mm <sup>2</sup> )	Impact Strength (ISO-V/+20°C)	Elongation (L <sub>0</sub> =5d <sub>0</sub> ) (%)
min. 400	570-700	min. 47 J	min. 30

**Typical Base Material Grades**

- EN: X2CrNiMoN 17 13 3, X2CrNiMoN 17 13 5, X2CrNiMoN 18 18 3, X2CrNiMoN 18 13, X4CrNiMoN 19 16 5, X4CrNiMoN 22 15, X2CrNiMo 18 14 3, X2CrNiMo 18 16 4, X10CrNiMoTi 18 12
- AISI & UNS: 316L, 316Cb, 317, S31726

**Features and Applications**

- Reduces the possibility of intergranular carbide precipitation, providing increase in resistance to intergranular corrosion without use of stabilizers such as Niobium or Titanium
- Rutile-basic coated alloyed-core wire electrode for corrosion-resistant CrNi steels of increased Mo-contents
- Requirement of Re-drying for min. 2 hours at the temperatures between 120°C and 200°C

**Welding Positions**

**Current Type**

D.C.(+) / A.C.

**Operating Data**

Product Code	Diameter x Length (mm) / (inch)		Welding Current (A)	Weight g / 100 pcs
3010101318	2.50 x 250	3/32 x 10"	50 - 90	1570
3010101323	3.20 x 350	1/8 x 14"	80 - 120	3470
3010101328	4.00 x 350	5/32 x 14"	110 - 160	5100

**Approvals:** TSE, CE, GOST-R, SEPRO

**Standards**

TS EN ISO 3581-A	: E 19 12 3 Nb R 32
EN ISO 3581-A	: E 19 12 3 Nb R 32
AWS A5.4	: ~E318-16

**Chemical Composition of  
Weld Metal % (Typical)**

C	Si	Mn	Mo	Ni	Cr	Nb
0.04	0.8	0.8	2.8	11.0	19.4	+

**Mechanical Properties**

Yield Strength (N/mm <sup>2</sup> )	Tensile Strength (N/mm <sup>2</sup> )	Impact Strength (ISO-V/+20°C)	Elongation (L <sub>0</sub> =5d <sub>0</sub> ) (%)
min. 390	580-750	min. 47 J	min. 30

**Typical Base Material Grades**

- EN: X6CrNiMoTi 17 12 2, X6CrNiMoNb 1 12 2, X5CrNiMo 17 13 2, G-XCrNiMo 18 10, X10CrNiMoNb 18 12, X5CrNiMo 17 13 3, G-X10CrNiMo 18 10, G-X10CrNiNb 18 10,
- AISI: 316Ti, 316Cb, 316L

**Features and Applications**

- Used for the welding of tanks and pipes made of Cr-Ni-Mo-alloyed, stabilized steels which are used in food, chemical textile and paint industries
- The weld metal stabilized by Nb is resistant to temperatures up to +400°C
- Requirement of Re-drying for min. 2 hours at the temperatures between 120°C and 200°C

**Welding Positions**

**Current Type**

D.C.(+) / A.C.

**Operating Data**

Product Code	Diameter x Length (mm) / (inch)		Welding Current (A)	Weight g / 100 pcs
3010101333	2.00 x 250	5/64 x 10"	40 - 60	930
3010101338	2.50 x 250	3/32 x 10"	50 - 90	1540
3010101343	3.20 x 300	1/8 x 12 "	80 - 120	3030
3010101348	3.20 x 350	1/8 x 14 "	80 - 120	3530
3010101353	4.00 x 350	5/32 x 14"	110 - 160	5150

**Approvals:** TSE, CE, GOST-R, SEPRO

**Standards**

TS EN ISO 3581-A	: E 19 12 3 Nb B 22
EN ISO 3581-A	: E 19 12 3 Nb B 22
AWS A5.4	: E 318-15

**Chemical Composition of  
Weld Metal % (Typical)**

C	Si	Mn	Mo	Ni	Cr	Nb
0.04	0.45	1.45	2.75	11.5	20.0	+

**Mechanical Properties**

Yield Strength (N/mm <sup>2</sup> )	Tensile Strength (N/mm <sup>2</sup> )	Impact Strength (ISO-V/+20°C)	Elongation (L <sub>0</sub> =5d <sub>0</sub> ) (%)
min. 390	590-730	min. 55 J	min. 30

**Typical Base Material Grades**

- EN: X6CrNiMoTi 17 12 2, X6CrNiMoNb 1 12 2, X5CrNiMo 17 13 2, G-XCrNiMo 18 10, X10CrNiMoNb 18 12, X5CrNiMo 17 13 3, G-X10CrNiMo 18 10, G-X10CrNiNb 18 10,
- AISI: 316Ti, 316Cb, 316L

**Features and Applications**

- Stabilized alloyed-core wire austenitic electrode with basic coating. Intended for use in all industries where analogous steels, including ferritic 13% chromium steels, are welded. Weld metal has high ductility, therefore preferably used for heavy sections. Very good out-of-position weldability. Resistant to intergranular corrosion up to 400°C. The weld metal does not require preheating or postweld heat treatment

**Welding Positions**

**Current Type**

D.C.(+)

**Operating Data**

Product Code	Diameter x Length (mm) / (inch)		Welding Current (A)	Weight g / 100 pcs
3010101358	2.50 x 250	3/32 x 10"	60 - 80	1450
3010101363	3.20 x 350	1/8 x 14"	80 - 110	3500
3010101368	4.00 x 350	5/32 x 14"	110 - 150	5300

**Approvals:** TSE, CE, GOST-R, SEPRO

**Standards**

TS EN ISO 3581-A : E 25 4 B 22
EN ISO 3581-A : E 25 4 B 22

**Chemical Composition of  
Weld Metal % (Typical)**

C	Si	Mn	Ni	Cr
0.12	0.4	1.3	5.0	25.5

**Mechanical Properties**

Yield Strength (N/mm <sup>2</sup> )	Tensile Strength (N/mm <sup>2</sup> )	Impact Strength (ISO-V/+20°C)	Elongation (L <sub>0</sub> =5d <sub>0</sub> ) (%)
min. 500	650-780	min. 30 J	min. 15

**Typical Base Material Grades**

- EN: X20CrNiSi 25 4, G-X40CrNiSi 27 4, X10CrAl7, X10CrAl 13, X10CrAl 18, X10CrAl 24, G-X30CrSi 6, G-X40CrSi 17
- AISI: 327

**Features and Applications**

- Used for the fabrication of furnace, boilers, etc. That made of heat resistant steels (CrNi and CrNiAl alloyed steels)
- For furnace requiring elevated resistance to reducing and oxidizing sulphurous gases as well as for final passes of weld joints in heat-resistant CrSiAl-steels
- Scaling resistance up to 1100°C

**Welding Positions**

**Current Type**

D.C.(+)

**Operating Data**

Product Code	Diameter x Length (mm) / (inch)		Welding Current (A)	Weight g / 100 pcs
3010101373	2.50 x 250	3/32 x 10"	50 - 80	1560
3010101378	3.20 x 350	1/8 x 14"	80 - 105	3270
3010101383	4.00 x 350	5/32 x 14"	100 - 130	4940

**Approvals:** TSE, CE, GOST-R, SEPRO

**Standards**

TS EN ISO 3581-A	: E 19 9 Nb R 32
EN ISO 3581-A	: E 19 9 Nb R 32
AWS A5.4	: E 347-16

**Chemical Composition of  
Weld Metal % (Typical)**

C	Si	Mn	Ni	Cr	Nb
0.04	0.8	0.9	10.0	19.8	+

**Mechanical Properties**

Yield Strength (N/mm <sup>2</sup> )	Tensile Strength (N/mm <sup>2</sup> )	Impact Strength (ISO-V/+20°C)	Elongation (L <sub>0</sub> =5d <sub>0</sub> ) (%)
min. 390	570-740	min. 47 J	min. 35

**Typical Base Material Grades**

- EN: X6CrNiNb 18 10, X6CrNiTi 18 10, G-X5CrNiNb 18 9, X5CrNi 18 10, X12CrNiTi 18 9, G-X10CrNi 18 8, X10CrNiNb 18 10, X2CrNi 19 11
- AISI: 347, 321, 304, 304LN

**Features and Applications**

- Used for the welding of tanks and pipes in which milk and beer is kept
- Also used for the welding of acid, gas, steam and water armatures
- Resistant to acid and corrosion, stabilized by Nb. Weld metal can resist to temperatures up to +400°C
- Requirement of Re-drying for min. 2 hours at the temperatures between 120°C and 200°C

**Welding Positions**

**Current Type**

D.C. (+) / A.C.

**Operating Data**

Product Code	Diameter x Length (mm) / (inch)		Welding Current (A)	Weight g / 100 pcs
3010101388	2.00 x 250	5/64 x 10"	40 - 60	940
3010101393	2.50 x 250	3/32 x 10"	50 - 90	1500
3010101398	3.20 x 300	1/8 x 12"	80 - 120	2980
3010101403	3.20 x 350	1/8 x 14"	80 - 120	3470
3010101408	4.00 x 350	5/32 x 14"	110 - 160	5150

**Approvals:** TSE, CE, GOST-R, SEPRO

**Standards**

TS EN ISO 3581-A	: E 19 9 Nb B 22
EN ISO 3581-A	: E 19 9 Nb B 22
AWS A5.4	: E 347-15

**Chemical Composition of  
Weld Metal % (Typical)**

C	Si	Mn	Ni	Cr	Nb
0.04	0.45	1.4	10.2	19.8	0.4

**Mechanical Properties**

Yield Strength (N/mm <sup>2</sup> )	Tensile Strength (N/mm <sup>2</sup> )	Impact Strength (ISO-V/+20°C)	Elongation (L <sub>0</sub> =5d <sub>0</sub> ) (%)
min. 400	600-740	min. 55 J	min. 30

**Typical Base Material Grades**

- EN & DIN: X6CrNiNb 18 10, X6CrNiTi 18 10, X5CrNi 18 10, X5CrNi 18 10, X2CrNiN 18 10, X2CrNi 19 11, G-X5CrNiNb 19 10, G-X10CrNi 18 8,
- AISI: 347, 321, 304, 304LN, 302, ASTM; A296 Gr.CF8C, A157 Gr C9, A320 Gr B 8C & D

**Features and Applications**

- Stabilized alloyed-core wire austenitic electrode with basic coating for use in all industries where similar steel types as well as ferritic 13% chromium steels are welded
- High ductility of the weld metal, therefore preferable for welding heavy sections
- Very good out-of-position weldability Good low-temperature-ductility down to -196°C
- Resistant to intergranular corrosion up to 400°C
- Weld metal does not require preheating or postweld heat treatment

**Welding Positions**

**Current Type**

D.C.(+)

**Operating Data**

Product Code	Diameter x Length (mm) / (inch)		Welding Current (A)	Weight g / 100 pcs
3010101413	2.50 x 250	3/32 x 10"	60-80	1460
3010101418	3.20 x 350	1/8 x 14"	80-120	3250
3010101423	4.00 x 350	5/32 x 14"	100-150	5100

**Approvals:** TSE, CE, GOST-R, SEPRO

**Standards**

TS EN ISO 3581-A : E 20 25 5 Cu N L R 32
EN ISO 3581-A : E 20 25 5 Cu N L R 32
AWS A5.4 : E 385 -16

**Chemical Composition of  
Weld Metal % (Typical)**

C	Si	Mn	Mo	Ni	Cr	Cu
<0.03	0.75	1.0	4.5	25.0	20.0	1.5

**Mechanical Properties**

Yield Strength (N/mm <sup>2</sup> )	Tensile Strength (N/mm <sup>2</sup> )	Impact Strength (ISO-V/+20°C)	Elongation (L <sub>0</sub> =5d <sub>0</sub> ) (%)
min. 400	550-700	min. 47 J	min. 30

**Typical Base Material Grades**

- EN & DIN: X5NiCrMoCuNb 20 18, X5NiCrMoCuTi 20 18, X2NiCrMoCu 25 20 5, X5NiCrMoCuNb 22 18, G-X7CrNiMoCuNb 18 18, G-X7NiCrMoCuNb 25 20
- AISI: 317L, 904L

**Features and Applications**

- Resistant to intercrystalline corrosion / wet corrosion up to 350°C
- High corrosion resistance similar to that of matching steels / cast steel grades, above all in reducing environments
- For joining and surfacing work on matching austenitic CrNiMoCu steels/cast steel grades
- For joining these types of steels with unalloyed / low alloy steels / cast steel grades
- Re-drying: 120°C - 200°C / min. 2h

**Welding Positions**

**Current Type**

D.C.(+) / A.C.

**Operating Data**

Product Code	Diameter x Length (mm) / (inch)		Welding Current (A)	Weight g / 100 pcs
3010101428	2.50 x 250	3/32 x 10"	50 - 90	1570
3010101433	3.20 x 350	1/8 x 14"	80 - 120	3470
3010101438	4.00 x 350	5/32 x 14"	110 - 160	5200

**Approvals:** TSE, CE, GOST-R, SEPRO



**Standards**

TS EN ISO 3581-A	: E Z 20 25 5 Cu N L B 22
EN ISO 3581-A	: E Z 20 25 5 Cu N L B 22
AWS A5.4	: E 385 -15

**Chemical Composition of  
Weld Metal % (Typical)**

C	Si	Mn	Mo	Ni	Cr	Cu	Nb
<0.025	0.40	2.2	3.5	25.0	22.0	2.2	0.35

**Mechanical Properties**

Yield Strength (N/mm <sup>2</sup> )	Tensile Strength (N/mm <sup>2</sup> )	Impact Strength (ISO-V/+20°C)	Elongation (L <sub>0</sub> =5d <sub>0</sub> ) (%)
min. 380	600-700	80 J	min. 35

**Typical Base Material Grades**

- EN & DIN: X5NiCrMoCuNb 20 18, X5NiCrMoCuTi 20 18, X2NiCrMoCu 25 20 5, X5NiCrMoCuNb 22 18, G-X7CrNiMoCuNb 18 18, G-X7NiCrMoCuNb 25 20
- AISI: 307, 307L, 904L

**Features and Applications**

- Basic coated alloyed-core wire special electrode for corrosion - resistant high-Molybdenum CrNi steels
- Recommended for highly corrosive environments
- Apart from its markedly good chemical resistance to stress corrosion cracking and crevice corrosion, the weld metal features high resistance to pitting
- Particularly recommended for steels containing up to 5% molybdenum

**Welding Positions**

**Current Type**

D.C.(+)

**Operating Data**

Product Code	Diameter x Length (mm) / (inch)		Welding Current (A)	Weight g / 100 pcs
3010101443	2.50 x 250	3/32 x 10"	50 - 90	1573
3010101448	3.20 x 350	1/8 x 14"	80 - 120	3563
3010101453	4.00 x 350	5/32 x 14"	110 - 150	4570

**Approvals:** TSE, CE, GOST-R, SEPRO

**Standards**

TS EN ISO 3581-A : E 13 B 22
EN ISO 3581-A : E 13 B 22
AWS A5.4 : E 410-15

**Chemical Composition of  
Weld Metal % (Typical)**

C	Si	Mn	Cr
0.07	0.7	0.8	13.5

**Mechanical Properties**

Yield Strength (N/mm <sup>2</sup> )	Tensile Strength (N/mm <sup>2</sup> )	Impact Strength (ISO-V/+20°C)	Hardness (HB)	
			as welded	750°C/2h/furnace
min. 450	650-800	min. 15 J	~350	200

**Typical Base Material Grades**

- X6Cr 13, X6CrAl 13, X15Cr 13, X10Cr 13, G-X10Cr 13

**Features and Applications**

- 13% Cr used in the joining and surfacing welding of martensitic and martensitic-ferritic steels with 13% Cr and steel casts. (This electrode is also strong at filling in the surfaces of gas, water and steam armatures)
- Annealing at 750°C for 2 hours, cooling down to room temperature in the furnace
- Re-drying: 300°C - 350°C / min. 2h

**Welding Positions**

**Current Type**

D.C.(+)

**Operating Data**

Product Code	Diameter x Length (mm) / (inch)		Welding Current (A)	Weight g / 100 pcs
3010101458	2.50 x 250	3/32 x 10"	50 - 90	1500
3010101463	3.20 x 350	1/8 x 14"	80 - 120	3140
3010101468	4.00 x 350	5/32 x 14"	110 - 160	4690

**Approvals:** TSE, CE, GOST-R, SEPRO

**Standards**

TS EN ISO 3581-A	: E 13 4 B 42
EN ISO 3581-A	: E 13 4 B 42
AWS A5.4	: E 410 NiMo-15

**Chemical Composition of  
Weld Metal % (Typical)**

C	Si	Mn	Mo	Ni	Cr
0.04	0.2	0.45	0.5	4.2	12.3

**Mechanical Properties**

Yield Strength (N/mm <sup>2</sup> )	Tensile Strength (N/mm <sup>2</sup> )	Impact Strength (ISO-V/+20°C)	Elongation (L <sub>0</sub> =5d <sub>0</sub> ) (%)	Hardness (HB)
min. 500	min. 760	min. 47 J	min. 15	~360

**Typical Base Material Grades**

- X5CrNi 13 4, G-X5CrNi 13 4, X6Cr13 , G-X5CrNi 13 6

**Features and Applications**

- Electrode with rutile coating on alloyed core-wire
- Applicability in welding Cr-Ni -alloyed austenitic high-temperature steels
- Usability in welding at all positions except for vertical downward position
- Applicability in joint-welding and surfacing of heat-resisting similar-type steels and steel castings.
- Serviceability at temperatures of values up to 700 °C
- Resistance to fracture and corrosion
- Creep resistance at high temperatures being higher than that of the electrode ELOX R 308 L
- Re-drying: 300° - 350°C / min. 2 h

**Welding Positions**

**Current Type**

D.C.(+)

**Operating Data**

Product Code	Diameter x Length (mm) / (inch)		Welding Current (A)	Weight g / 100 pcs
3010101473	2.50 x 250	3/32 x 10"	50 - 90	1500
3010101478	3.20 x 350	1/8 x 14"	90 - 110	3260
3010101483	4.00 x 350	5/32 x 14"	110 - 160	4930

**Approvals:** TSE, CE, GOST-R, SEPRO

**Standards**

TS EN ISO 3581-A	: E 13 4 B 62
EN ISO 3581-A	: E 13 4 B 62
AWS A5.4	: E 410NiMo-25

**Chemical Composition of  
Weld Metal % (Typical)**

C	Si	Mn	Mo	Ni	Cr
0.05	0.3	0.5	0.5	4.5	11.5

**Mechanical Properties**

Yield Strength (N/mm <sup>2</sup> )	Tensile Strength (N/mm <sup>2</sup> )	Impact Strength (ISO-V/+20°C)	Elongation (L <sub>0</sub> =5d <sub>0</sub> ) (%)	Hardness (HB)
min. 600	800-980	min. 47 J	min. 15	~270

**Typical Base Material Grades**

- X5CrNi 13 4, G-X5CrNi 13 4, X6Cr 13, G-X5CrNi 13 6

**Features and Applications**

- Basic coated electrode for welding similar corrosion-resistant, martensitic and martensitic-ferritic rolled, forged and cast steels
- Used in the construction of hydroturbines, compressors and steam power plants
- Resistant to corrosion caused by water, steam and sea water atmosphere
- Excellent slag removability and smooth bead appearance
- Metal recovery approx. 130% Out-of-position weldability
- Preheating and interpass temperatures of thick-walled components 100°C-160°C
- Tempering temperature 580°C-620°C
- Re-drying: 300°C - 350°C / min. 2 h

**Welding Positions**

**Current Type**

D.C.(+)

**Operating Data**

Product Code	Diameter x Length (mm) / (inch)		Welding Current (A)	Weight g / 100 pcs
3010101488	2.50 x 350	3/32 x 14"	70 - 110	1960
3010101493	3.20 x 350	1/8 x 14"	110 - 150	3630
3010101498	4.00 x 350	5/32 x 14"	150 - 190	5550

**Approvals:** TSE, CE, GOST-R, SEPRO

**Standards**

TS EN ISO 3581-A	: E 17 B 22
EN ISO 3581-A	: E 17 B 22
AWS A5.4	: E 430 - 15

**Chemical Composition of  
Weld Metal % (Typical)**

C	Si	Mn	Cr
0.08	0.5	0.4	17.0

**Mechanical Properties**

Yield Strength (N/mm <sup>2</sup> )	Tensile Strength (N/mm <sup>2</sup> )	Elongation (L <sub>0</sub> =5d <sub>0</sub> ) (%)	Hardness (HB)	
			as welded	750°C/2h/furnace
min. 350	540-660	min. 20	~270	~200

**Typical Base Material Grades**

- X6CrTi 17, X20CrNi17-2, 431, 430 Ti

**Features and Applications**

- Mainly used for corrosion-resistant, wear-resistant surfacing applications
- Preferably for surfacing on sealing faces of gas, water and steam valves
- Scaling resistance up to 900°C
- Weld metal protector hardness up to 500°C

**Welding Positions**

**Current Type**

D.C.(+)

**Operating Data**

Product Code	Diameter x Length (mm) / (inch)		Welding Current (A)	Weight g / 100 pcs
3010101503	2.50 x 250	3/32 x 10"	50 - 90	1400
3010101508	3.20 x 350	1/8 x 14"	80 - 120	3000
3010101513	4.00 x 350	5/32 x 14"	110 - 160	4600

**Approvals:** TSE, CE, GOST-R, SEPRO

**Standards**

TS EN ISO 3581-A	: E Z 17 Mo B 22
EN ISO 3581-A	: E Z 17 Mo B 22

**Chemical Composition of  
Weld Metal % (Typical)**

C	Si	Mn	Mo	Cr
0.2	0.5	0.5	1.2	17.0

**Mechanical Properties**

Yield Strength (N/mm <sup>2</sup> )	Tensile Strength (N/mm <sup>2</sup> )	Elongation (L <sub>0</sub> =5d <sub>0</sub> ) (%)	Hardness (HB)	
			as welded	750°C/2h/furnace
min. 490	650-750	min. 15	~400	~250

**Typical Base Material Grades**

- GS-C 25, X22CrNi 17, 41Cr4

**Features and Applications**

- Basic coated alloyed core wire electrode with good weldability in all positions except vertical-down
- Mainly used for hard surfacing, corrosion resistant, wear resistant
- Preferably employed for sealing faces of gas, water and steam valves
- In the machined condition, at least a two-layer buildup should remain on the surface
- The weld metal features retention of hardness up to 500°C
- Sea water resistant, scalling resistant up to 900°C
- Preheating as required by the base metal, with temperatures between 100°C and 200°C being generally sufficient (for joining operations 250° - 400°C)
- Annealing at 650°C - 750°C may be carried out to improve the toughness values in the weld metal and in the transition zone

**Welding Positions**

**Current Type**

D.C.(+)

**Operating Data**

Product Code	Diameter x Length (mm) / (inch)		Welding Current (A)	Weight g / 100 pcs
3010101518	2.50 x 250	3/32 x 10"	50 - 90	1650
3010101523	3.20 x 350	1/8 x 14"	80 - 120	3030
3010101528	4.00 x 350	5/32 x 14"	110 - 160	4630

**Approvals:** TSE, CE, GOST-R, SEPRO

**Standards**

TS EN ISO 3581-A	: E 22 9 3 N L R 32
EN ISO 3581-A	: E 22 9 3 N L R 32
AWS A5.4	: E 2209 - 17

**Chemical Composition of  
Weld Metal % (Typical)**

C	Si	Mn	Mo	Ni	Cr	N
0.03	0.5	0.9	2.7	10.0	22.0	0.12

**Mechanical Properties**

Yield Strength (N/mm <sup>2</sup> )	Tensile Strength (N/mm <sup>2</sup> )	Impact Strength (ISO-V/+20°C)	Elongation (L <sub>0</sub> =5d <sub>0</sub> ) (%)
min. 520	690-850	min. 47 J	min. 20

**Typical Base Material Grades**

- X2CrNiMoN22-5-3, X2CrNiMoN23-4, X2CrNiMoN22-5-3 with X2CrNiMoNb18-12, X2CrNiMoN22-5-3 with P235GH/ P265GH, S255N, P295GH, S355N, 16Mo3

**Features and Applications**

- Applicability in welding duplex steels
- Suitability to joint- and surfacing applications of similar-type austenitic steels and cast steels
- Electrode coating of rutile character
- Excellent weldability
- Very high resistance to stress corrosion cracking and to corrosion at particularly chlorious and sulphurous media
- In the liquid conditions at chemical industry, serviceability at temperatures of values up to 280°C
- Re-drying : 250°C - 300°C / min. 2h

**Welding Positions**

**Current Type**

D.C.(+) / A.C.

**Operating Data**

Product Code	Diameter x Length (mm) / (inch)		Welding Current (A)	Weight g / 100 pcs
3010101533	2.50 x 250	3/32 x 10"	50 - 90	1410
3010101538	3.20 x 350	1/8 x 14"	80 - 120	3540
3010101543	4.00 x 350	5/32 x 14"	110 - 160	5200

**Approvals:** TSE, CE, ABS, BV, GOST-R, Class NK, SEPRO

**Standards**

TS EN ISO 3581-A	: E 22 9 3 N L B 22
EN ISO 3581-A	: E 22 9 3 N L B 22
AWS A5.4	: E 2209-15

**Chemical Composition of  
Weld Metal % (Typical)**

C	Si	Mn	Mo	Ni	Cr	N
0.03	0.4	1.3	2.6	9.0	22.0	0.14

**Mechanical Properties**

Yield Strength (N/mm <sup>2</sup> )	Tensile Strength (N/mm <sup>2</sup> )	Impact Strength		Elongation (L <sub>0</sub> =5d <sub>0</sub> ) (%)
		(ISO-V/+20°C)	(ISO-V/-60°C)	
min. 520	690-850	min. 80 J	min. 40 J	min. 30

**Typical Base Material Grades**

- X2CrNiMoN22-5-3, X2CrNiMoN23-4, X2CrNiMoN22-5-3 with X2CrNiMoNb18-1, X2CrNiMoN22-5-3 with P235GH/ P265GH, S255N, P295GH, S355N, 16Mo3

**Features and Applications**

- Applicability in welding duplex steels
- Suitability to joint- and surfacing applications of similar-type austenitic steels and cast steels.
- Electrode coating of basic character
- Excellent weldability
- Very high resistance to stress corrosion cracking and to corrosion at particularly chlorious and sulphurous media
- In the liquid conditions at chemical industry, serviceability at temperatures of values up to 280°C
- Re-drying: 250°C - 300°C / min. 2h

**Welding Positions**

**Current Type**

D.C.(+)

**Operating Data**

Product Code	Diameter x Length (mm) / (inch)		Welding Current (A)	Weight g / 100 pcs
3010101548	2.50 x 250	3/32 x 10"	60-80	1550
3010101558	3.20 x 300	1/8 x 12"	80-110	2850
3010101568	4.00 x 350	5/32 x 14"	110-140	5140

**Approvals:** TSE, CE, GOST-R, SEPRO



**Standards**

TS EN ISO 3581-A	: E 25 9 4 N L B 42
EN ISO 3581-A	: E 25 9 4 N L B 42
AWS A5.4	: E 2594 - 15

**Chemical Composition of  
Weld Metal % (Typical)**

C	Si	Mn	Mo	Ni	Cr	N
0.035	0.35	1.45	3.8	8.6	24.0	0.25

**Mechanical Properties**

Yield Strength (N/mm <sup>2</sup> )	Tensile Strength (N/mm <sup>2</sup> )	Impact Strength (ISO-V/+20°C)	Elongation (L <sub>0</sub> =5d <sub>0</sub> ) (%)
min. 550	min. 760	min. 47 J	min. 18

**Typical Base Material Grades**

- 1.4410 , X2CrNiMoN 25-7-4, 1.4501, X2CrNiMoCuWN 25-7-4, 1.4507, X2CrNiMoCuN 25-6-3
- UNS S32750, S32760, S32550

**Features and Applications**

- Basic type electrode which used especially for the welding of duplex steels. It provides high yield and tensile strength and the weld metal is resistant to pitting corrosion
- Re-drying : 250°C - 300°C / min. 2h

**Welding Positions**

**Current Type**

D.C.(+)

**Operating Data**

Product Code	Diameter x Length (mm) / (inch)		Welding Current (A)	Weight g / 100 pcs
3010101573	2.50 x 250	3/32 x 10"	60 - 80	1470
3010101578	3.20 x 300	1/8 x 12"	80 - 120	2870

**Approvals:** CE, GOST-R, SEPRO

**Standards**

TS EN ISO 3581-A	: E Z 16 8 2 B 22
EN ISO 3581-A	: E Z 16 8 2 B 22
AWS A5.4	: E 16 8 2-15

**Chemical Composition of  
Weld Metal % (Typical)**

C	Cr	Ni	Mo
0.05	16.0	8.5	1.3

**Mechanical Properties**

Yield Strength (N/mm <sup>2</sup> )	Tensile Strength (N/mm <sup>2</sup> )	Impact Strength (ISO-V/+20°C)	Elongation (L <sub>0</sub> =5d <sub>0</sub> ) (%)
min. 410	min. 550	min. 47 J	min. 35

**Features and Applications**

- Basic coated electrode is used primarily for welding stainless steel, such as types 16-8-2, 316, and 347, for high pressure, high-temperature piping systems
- A controlled chemical composition and ferrite number (<5 FN) of weld metal gives good creep, oxidation and general corrosion resistance

**Welding Positions**

**Current Type**

D.C.(+)

**Operating Data**

Product Code	Diameter x Length (mm) / (inch)		Welding Current (A)	Weight g / 100 pcs
3010101618	3.20 x 350	1/8 x 14"	100 - 130	3200

**Approvals:** CE, GOST-R, SEPRO

### Standards

TS 9463 EN ISO 1071	: E C Ni-Cl 1
EN ISO 1071	: E C Ni-Cl 1
AWS A5.15	: E Ni-Cl

### Chemical Composition of Weld Metal % (Typical)

C	Ni
0.5	rest

### Mechanical Properties

Yield Strength (N/mm <sup>2</sup> )	Tensile Strength (N/mm <sup>2</sup> )	Elongation (L <sub>0</sub> =5d <sub>0</sub> ) (%)	Hardness (HB)
200	250	3	~170

### Features and Applications

- Joint welding of grey cast iron, temper cast iron, nodular cast iron as well as joint welding of cast iron with steel, stainless steel and Monel metal
- Ni cored stick electrode
- Welding in short passes, and gently striking the bead of each pass with a hammer when the bead is hot are required

### Welding Positions



### Current Type

D.C.(-) / A.C.

### Operating Data

Product Code	Diameter x Length (mm) / (inch)		Welding Current (A)	Weight g / 100 pcs
3010101623	2.50 x 300	3/32 x 12"	60- 90	1860
3010101630	3.20 x 300	1/8 x 12"	90-110	2880
3010101644	4.00 x 400	5/32 x 16"	110-130	6070

**Approvals:** CE, GOST-R, SEPRO, RCB

**Standards**

TS 9463 EN ISO 1071	: E C Ni-CI 3
EN ISO 1071	: E C Ni-CI 3
AWS A5.15	: E Ni-CI

**Chemical Composition of  
Weld Metal % (Typical)**

Fe	Ni
7.0	rest

**Mechanical Properties**

Yield Strength (N/mm <sup>2</sup> )	Tensile Strength (N/mm <sup>2</sup> )	Elongation (L <sub>0</sub> =5d <sub>0</sub> ) (%)	Hardness (HB)
200	250	3	~170

**Features and Applications**

- Ni cored stick electrode
- Welding in short passes, and gently, striking the bead of each pass with a hammer when the bead is hot
- Joint welding of grey cast iron, temper cast iron, nodular cast iron and joint welding of cast iron with steel
- Weld metal recovery of approx. 110%

**Welding Positions**

**Current Type**

D.C.(-) / A.C.

**Operating Data**

Product Code	Diameter x Length (mm) / (inch)		Welding Current (A)	Weight g / 100 pcs
3010101674	4.00 x 400	5/32 x 16"	110 - 140	6820

**Approvals:** CE, SEPRO, GOST-R

**Standards**

TS 9463 EN ISO 1071	: E C Ni-CI 1
EN ISO 1071	: E C Ni-CI 1
AWS A5.15	: ENi-CI

**Chemical Composition of  
Weld Metal % (Typical)**

C	Ni
0.5	min. 96

**Mechanical Properties**

Yield Strength (N/mm <sup>2</sup> )	Tensile Strength (N/mm <sup>2</sup> )	Elongation (L <sub>0</sub> =5d <sub>0</sub> ) (%)	Hardness (HB)
200	250	3	~170

**Features and Applications**

- Non-conductive, basic-graphite-coated nickel stick electrode
- Repair welding of problematic cast iron parts of irregular shapes
- Joint welding of cast iron parts, and cast iron parts to steel parts
- Pre-heating to 200 °C is recommended for thick- walled components
- Welding in short runs, and peening are required

**Welding Positions**

**Current Type**

D.C.(+)

**Operating Data**

Product Code	Diameter x Length (mm) / (inch)		Welding Current (A)	Weight g / 100 pcs
3010101651	2.50 x 300	3/32 x 12"	70 - 100	1950
3010101658	3.20 x 300	1/8 x 12"	90 - 110	2940
3010101665	4.00 x 400	5/32 x 16"	110 - 130	5250

**Approvals:** CE, GOST-R, SEPRO

### Standards

TS 9463 EN ISO 1071	: E C NiFe CI 1
EN ISO 1071	: E C NiFe CI 1
AWS A5.15	: E NiFe-CI

### Chemical Composition of Weld Metal % (Typical)

Fe	Ni
>40.0	>45.0

### Mechanical Properties

Yield Strength (N/mm <sup>2</sup> )	Tensile Strength (N/mm <sup>2</sup> )	Elongation (L <sub>0</sub> =5d <sub>0</sub> ) (%)	Hardness (HB)
200	350	6	~190

### Features and Applications

- Welding of grey cast iron, temper cast iron
- Joint welding of cast iron with hard-to-weld steels or cast parts
- Ni-Fe cored stick electrode
- Welding in short passes, and hammering the bead of each pass through gentle strikes are required

### Welding Positions



### Current Type

D.C.(+)

### Operating Data

Product Code	Diameter x Length (mm) / (inch)		Welding Current (A)	Weight g / 100 pcs
3010101683	2.50 x 300	3/32 x 12"	60 - 90	1790
3010101690	3.20 x 300	1/8 x 12"	80 - 120	2670
3010101697	4.00 x 400	5/32 x 16"	110 - 150	5390

**Approvals:** CE, GOST-R, SEPRO

**Standards**

TS 9463 EN ISO 1071	: E C NiCu-B1
EN ISO 1071	: E C NiCu-B1
AWS A5.15	: ~ E NiCu B

**Chemical Composition of  
Weld Metal % (Typical)**

Ni	Cu
~ 68.0	~30.0

**Mechanical Properties**

Yield Strength (N/mm <sup>2</sup> )	Tensile Strength (N/mm <sup>2</sup> )	Elongation (L <sub>0</sub> =5d <sub>0</sub> ) (%)	Hardness (HB)
min. 190	300	min. 15	~140

**Features and Applications**

- Soft joint welding of grey cast iron
- Filler welding, repair welding and gently striking the bead of each pass with a hammer when the bead is hot are required
- Ni-Cu cored stick electrode

**Welding Positions**

**Current Type**

D.C.(-) / A.C.

**Operating Data**

Product Code	Diameter x Length (mm) / (inch)		Welding Current (A)	Weight g / 100 pcs
3010101704	2.50 x 300	3/32 x 12"	60 - 90	1850
3010101711	3.20 x 300	1/8 x 12"	90 - 110	2860
3010101718	4.00 x 400	5/32 x 16"	110 - 130	5790

**Approvals:** CE, GOST-R, SEPRO

### Standards

TS 9463 EN ISO 1071	: E C Fe-2
EN ISO 1071	: E C Fe-2

### Chemical Composition of Weld Metal % (Typical)

C	Mn	Si	V
0.07	1.0	0.8	8.0

### Mechanical Properties

Weld Metal Hardness (HB)
~ 250

### Features and Applications

- Repair of welding defects, for facing of worn-out parts of mold of automobile body, shielding process of metal frictioning works
- Good results at joint welding of steel with cast iron
- Basic coated, Barium compound free, iron base, Vanadium alloyed cast iron electrode, which is used for repairing and maintenance of defective lamellar and nodular cast iron equipment and machine parts. Also used for hard face welding of wear susceptible of cast iron parts
- Advantages of this Nickel free cast iron electrode is;
- The deposit metal is a close color match to cast iron,
- The similarity of chemical composition of weld metal and cast iron assures similar that expansion and contraction characteristics, as a result there is no subject about thermal deformation
- When welding, electrode is not hot, as a result welding can be done uninterrupted and more quickly

### Welding Positions



### Current Type

D.C.(+)

### Operating Data

Product Code	Diameter x Length (mm) / (inch)		Welding Current (A)	Weight g / 100 pcs
3010101725	2.50 x 350	3/32 x 1 4"	70 - 100	2270
3010101732	3.20 x 350	1/8 x 14"	100 - 120	3650
3010101739	4.00 x 350	5/32 x 14"	120 - 160	5260

**Approvals:** CE, GOST-R, SEPRO



**Standards**

TS EN 14700	: E Fe 1
EN 14700	: E Fe 1
DIN 8555	: E1-UM-250

**Chemical Composition of  
Weld Metal % (Typical)**

C	Mn	Si	Cr
0.15	1.0	0.8	1.0

**Mechanical Properties**

Weld Metal Hardness (HB)
240 - 280

**Features and Applications**

- For tough build-ups on rails, gearwheels, shafts, gear parts, and couplings
- For buffer layers on carbon steels and low-alloyed steels with concurrent extreme compressive stress on anti-wear surfaces
- Re-drying : 300°C / 2h

**Welding Positions**

**Current Type**

D.C.(+)

**Operating Data**

Product Code	Diameter x Length (mm) / (inch)		Welding Current (A)	Weight g / 100 pcs
3010101744	3.20 x 350	1/8 x 14"	100 - 140	3670
3010101747	4.00 x 450	5/32 x 18"	140 - 180	6820
3010101750	5.00 x 450	3/16 x 18"	180 - 230	10570

**Approvals:** CE, GOST-R, SEPRO

### Standards

TS EN 14700	: E Fe 1
EN 14700	: E Fe 1
DIN 8555	: E1-UM-300

### Chemical Composition of Weld Metal % (Typical)

C	Mn	Si	Cr
0.15	1.3	0.5	1.5

### Mechanical Properties

Weld Metal Hardness (HB)
280 - 330

### Features and Applications

- Basic coated electrode for medium hardness value
- For tough build-ups, particularly on Mn-Mo-alloyed wing and junction rails with mechanical strength of minimum 880 N/mm<sup>2</sup>
- Deposit offers ease of machining
- Pre-heating temperature 250°C-350°C.
- Re-drying : 300°C / 2h

### Welding Positions



### Current Type

D.C.(+)

### Operating Data

Product Code	Diameter x Length (mm) / (inch)		Welding Current (A)	Weight g / 100 pcs
3010101753	3.20 x 350	1/8 x 14"	100 - 140	3571
3010101759	4.00 x 450	5/32 x 18"	140 - 180	6775
3010101762	5.00 x 450	3/16 x 18"	180 - 230	10500

**Approvals:** CE, GOST-R, SEPRO

**Standards**

TS EN 14700	: E Fe 1
EN 14700	: E Fe 1
DIN 8555	: E1-UM-300

**Chemical Composition of  
Weld Metal % (Typical)**

C	Mn	Si	Cr
0.14	0.5	0.5	1.8

**Mechanical Properties**

Weld Metal Hardness (HB)	Weld Metal Hardness (HB) 900°C/cooled on water/tempered
300 - 330	450 - 470

**Features and Applications**

- Basic coated electrode for medium hardness value
- For tough build-ups, particularly on Mn-Mo-alloyed wing and junction rails with mechanical strength of minimum 880 N/mm<sup>2</sup>
- Deposit offers ease of machining
- It can use with alternating current
- Pre-heating temperature 250°C-350°C
- Re-drying : 300°C / 2h

**Welding Positions**

**Current Type**

D.C.(+) / A.C.

**Operating Data**

Product Code	Diameter x Length (mm) / (inch)		Welding Current (A)	Weight g / 100 pcs
3010101765	3.20 x 350	1/8x 14"	90 - 135	3520
3010101768	4.00 x 450	5/32 x 18"	135 - 180	6690

**Approvals:** CE, GOST-R, SEPRO

**Standards**

TS EN 14700	: E Fe 1
EN 14700	: E Fe 1
DIN 8555	: E1-UM-350

**Chemical Composition of  
Weld Metal % (Typical)**

C	Mn	Si	Cr
0.17	1.5	0.8	2.0

**Mechanical Properties**

Weld Metal Hardness (HB)
330 - 380

**Features and Applications**

- Basic-coated electrode
- Wear resistant surfacing on Mn-Cr-V alloyed frogs, track rollers, idlers, tracks, slideways and drive sprockets
- The deposits are machinable
- Re-drying : 300°C / 2h

**Welding Positions**

**Current Type**

D.C.(+)

**Operating Data**

Product Code	Diameter x Length (mm) / (inch)		Welding Current (A)	Weight g / 100 pcs
3010101774	3.20 x 350	1/8 x 14"	100 - 140	3600
3010101777	4.00 x 450	5/32 x 18"	140 - 180	6750
3010101780	5.00 x 450	3/16 x 18"	180 - 230	10540

**Approvals:** CE, GOST-R , SEPRO

**Standards**

TS EN 14700	: E Fe 1
EN 14700	: E Fe 1
DIN 8555	: E1-UM-400

**Chemical Composition of  
Weld Metal % (Typical)**

C	Mn	Si	Cr
0.14	1.5	0.6	2.0

**Mechanical Properties**

Weld Metal Hardness (HB)
400 - 430

**Features and Applications**

- Used for dozer, excavator, mineral mining machine equipment like ladle, idler, idler roller and their repair welding
- Re-drying : 300°C / 2h

**Welding Positions**

**Current Type**

D.C.(+)

**Operating Data**

Product Code	Diameter x Length (mm) / (inch)		Welding Current (A)	Weight g / 100 pcs
	3010101783	4.00 x 450		
3010101786	5.00 x 450	3/16 x 18"	180-230	10900

**Approvals:** CE, GOST-R, SEPRO

### Standards

TS EN 14700	: E Z Fe 1
EN 14700	: E Z Fe 1
DIN 8555	: E1-UM-50

### Chemical Composition of Weld Metal % (Typical)

C	Mn	Si	Cr
0.3	1.3	1.2	~5.5

### Mechanical Properties

Weld Metal Hardness (HRC)
~50

### Features and Applications

- Used in hardfacing applications of guide roller, rope pulleys, ladle lugs etc. for land, mineral and coal sector
- Weld metal has strength against friction and wear
- Pre-heating is generally 200°C according to base material
- Re-drying : 300°C / 2h

### Welding Positions



### Current Type

D.C.(+)

### Operating Data

Product Code	Diameter x Length (mm) / (inch)		Welding Current (A)	Weight g / 100 pcs
3010101792	3.20 x 350	1/8 x 14"	100 - 140	3600
3010101798	4.00 x 450	5/32 x 18"	140 - 180	7010
3010101804	5.00 x 450	3/16 x 18"	180 - 230	10900

**Approvals:** CE, GOST-R, SEPRO

**Standards**

TS EN 14700	: E Fe 8
EN 14700	: E Fe 8
DIN 8555	: E6-UM-60 P

**Chemical Composition of  
Weld Metal % (Typical)**

C	Mn	Si	Mo	V	Cr
0.5	0.5	1.1	1.0	1.0	7.5

**Mechanical Properties**

Weld Metal Hardness (HRC)	780- 820 °C Cooling in Furnace	1000 - 1050°C Hardening in Oil	300- 400°C Tempered
55-59	~ 25 HRC	~60 HRC	53 - 55 HRC

**Features and Applications**

- Final pass-welding of parts of earth-moving and mining equipment with high resistance to abraision, as well as of parts of hard manganese steels and frags
- Weld metal is resistant to abraision
- Re-drying : 300°C / 2h

**Welding Positions**

**Current Type**

D.C.(+)

**Operating Data**

Product Code	Diameter x Length (mm) / (inch)		Welding Current (A)	Weight g / 100 pcs
3010101810	3.20 x 350	1/8 x 14"	100 - 140	3660
3010101813	4.00 x 450	5/32 x 18"	140 - 180	6820
3010101816	5.00 x 450	5/16 x 18"	180 - 230	10500

**Approvals:** CE, SEPRO

**Standards**

TS EN 14700	: E Fe 8
EN 14700	: E Fe 8
DIN 8555	: E6-UM-60 P

**Chemical Composition of  
Weld Metal % (Typical)**

C	Cr	Si
0.5	9.0	1.8

**Mechanical Properties**

Weld Metal Hardness (HRC)	Soft Annealing	Hardening	Tempered
54 - 58	780- 820°C Slow Cooling in Furnace	1000 - 1050°C in oil	300- 400°C

**Features and Applications**

- Applicability in final-layer hardfacing of parts of earth and mineral mining machines, impact drilling and crushing devices, guide springs, edges of cutting tools, hard manganese steels, bucket edges and teeth, all of which are made of alloyed or unalloyed steels, as well as in other materials required to have high resistance to wear
- Electrode of basic type with thick coating
- Inclusion of chromium-silicon alloy, very hard electrode
- Weld metal with ductile and cracking-resistant behaviors: Crack resistance to impact forcing due to its high ductility: Machinability of weld metal through grinding only: Requirement of re-drying at 300°C for 2 hours for moistened electrodes: Recommended pre-heating at 200-300°C for welding thick work pieces and materials tending to get hardened: Requirement of 2-3 layers hardfacing to obtain the highest resistance to wear
- Suitability of harder and/or higher-quality steels to buffer-layering with the GeKa electrodes LASER B 50, TEMPO B 63, or, in some cases, with the GeKa electrodes such as ELOX B307, ELOX R 312
- Re-drying : 300°C / 2h

**Welding Positions**

**Current Type**

D.C.(+)

**Operating Data**

Product Code	Diameter x Length (mm) / (inch)		Welding Current (A)	Weight g / 100 pcs
3010101822	3.20 x 350	1/8 x 14"	100 - 140	3650
3010101825	4.00 x 450	5/32 x 18"	140 - 180	6840
3010101828	5.00 x 450	3/16 x 18"	180 - 230	10900

**Approvals:** CE, GOST-R, SEPRO



### Standards

TS EN 14700	: E Fe 8
EN 14700	: E Fe 8
DIN 8555	: E6-UM-60 P

### Chemical Composition of Weld Metal % (Typical)

C	Mn	Si	Mo	V	Cr
0.5	0.3	1.1	1.0	1.0	7.0

### Mechanical Properties

Weld Metal Hardness (HRC)
55 - 59

### Features and Applications

- Electrode covering of rutile character
- Usability with a welding transformer (Weldability with AC)
- Weld metal with ductile and cracking-resistant behaviors
- Requirement of re-drying at the temperature range of 300°C-350°C for 2 hours
- Applicability in final layer welding of earth and mineral mining machines. Impact drilling and crushing devices, guide springs, edges of cutting tools, hard manganese steels, bucket edges and teeth

### Welding Positions



### Current Type

D.C.(+) / A.C.

### Operating Data

Product Code	Diameter x Length (mm) / (inch)		Welding Current (A)	Weight g / 100 pcs
3010101831	3.20 x 350	1/8 x 14"	90 - 135	4170
3010101834	4.00 x 450	5/32 x 18"	135 - 180	7640
3010101837	5.00 x 450	3/16 x 18"	180 - 230	11670

**Approvals:** CE, GOST-R, SEPRO

### Standards

TS EN 14700	: E Fe 6
EN 14700	: E Fe 6
DIN 8555	: E6-UM-60

### Chemical Composition of Weld Metal % (Typical)

C	Mn	Si	Mo	Nb	Cr
0.55	1.35	0.75	1.2	0.6	6.8

### Mechanical Properties

#### Weld Metal Hardness (HRC)

56 - 59

### Features and Applications

- Used in hardfacing applications of earth-moving industry and wearing parts of grinders etc.
- Can be used directly. After three or more passes, buffer-layering must be done according to material grade. (ELHARD 63, ELHARD 250, ELOX R 307 and ELHARD 14 Mn)
- For hardenable steels, preheat temperature is 100-300°C
- Re-drying : 300°C / 2h

### Welding Positions



### Current Type

D.C.(+)

### Operating Data

Product Code	Diameter x Length (mm) / (inch)		Welding Current (A)	Weight g / 100 pcs
3010100333	3.20 x 350	1/8 x 14"	100 - 140	3846
3010101846	4.00 x 450	5/32 x 18"	140 - 180	6930
3010101849	5.00 x 450	3/16 x 18"	180 - 230	10900

**Approvals:** CE, GOST-R, SEPRO

**Standards**

TS EN 14700	: E Fe2
EN 14700	: E Fe2
DIN 8555	: E2-UM-60

**Chemical Composition of  
Weld Metal % (Typical)**

C	Mn	Si	Cr
0.7	0.5	3.5	3.5

**Mechanical Properties**

Weld Metal Hardness (HRC)
57 - 62

**Features and Applications**

- Resistance to abrasion and shocks
- Suitability for uses in hardfacing worn parts of crushing, drilling, excavating, grinding machines in mines/quarries/soil crushing plants
- Weld metal hardness can be exchange between 57 - 62 HRC according to welding current, number of passes, largeness of base metal and chemical composition of base metal

**Welding Positions**

**Current Type**

D.C.(+)

**Operating Data**

Product Code	Diameter x Length (mm) / (inch)		Welding Current (A)	Weight g / 100 pcs
	3010101855	4.00 x 450		
3010101858	5.00 x 450	3/16 x 18"	170 - 210	11200

**Approvals:** CE, GOST-R, SEPRO

**Standards**

TS EN 14700	: E Fe 2
EN 14700	: E Fe 2
DIN 8555	: ~E6-UM-60

**Chemical Composition of  
Weld Metal % (Typical)**

C	Mn	Si	Mo	V	Cr
0.5	1.5	1.2	0.8	0.8	4.7

**Mechanical Properties**

Weld Metal Hardness (HRC)
60 - 62

**Features and Applications**

- Hardfacing of workpieces of steel, cast steel or hard Mn-steel exposed to a combination of impact, compression and abrasive wearing, such as cam shafts, gliding surfaces, gears, plough shares, rails, shunts, crosses, baffle plates, excavator parts, rope carrier wheels etc.
- Weld metal does not cracking
- Re-drying : 300°C-350°C / 2h

**Welding Positions**

**Current Type**

D.C.(+)

**Operating Data**

Product Code	Diameter x Length (mm) / (inch)		Welding Current (A)	Weight g / 100 pcs
3010101861	3.20 x 350	1/8 x 14"	100 - 150	3920
3010101867	4.00 x 450	5/32 x 18"	140 - 180	7790
3010101870	5.00 x 450	3/16 x 18"	170 - 210	10750

**Approvals:** CE, GOST-R, SEPRO

**Standards**

TS EN 14700	: E Z Fe 9
EN 14700	: E Z Fe 9
DIN 8555	: E 7-UM-200K
AWS A5.13	: E FeMn-A

**Chemical Composition of  
Weld Metal % (Typical)**

C	Mn	Si	Ni
0.6	13.5	0.1	3.0

**Mechanical Properties**

Hardness (HB)	Hardness After Cold Deformation (HB)
180 - 220	~ 550

**Features and Applications**

- Hardfacing of mining and rock-crushing machine parts as well as of hard manganese steels.
- Machinability of weld metal only if it is not hammered when it is cold, or, if it is not put into operation for a while
- Re-drying at condition 300°C / 2h is required

**Welding Positions**

**Current Type**

D.C.(+)

**Operating Data**

Product Code	Diameter x Length (mm) / (inch)		Welding Current (A)	Weight g / 100 pcs
3010101876	3.20 x 350	1/8 x 14"	110 - 140	3700
3010101882	4.00 x 450	5/32 x 18"	150 - 180	6870
3010101885	5.00 x 450	3/16 x 18"	180 - 210	10900

**Approvals:** CE, GOST-R, SEPRO

**Standards**

TS EN 14700	: E Fe 1
EN 14700	: E Fe 1
DIN 8555	: E 3-UM-400-GPTS

**Chemical Composition of  
Weld Metal % (Typical)**

C	Mn	Si	Mo	V	Cr	W
0.2	1.1	0.8	0.6	0.4	3.2	0.5

**Mechanical Properties**

Hardness (HB)
380 - 440

**Features and Applications**

- Used in surface coating applications and dies made from hot work tool steels.
- According to the base material pre-heat and slow cooling can be done
- Weld metal keep its hardness until 500°C
- Re-drying: 300°C - 350°C / 2h

**Welding Positions**

**Current Type**

D.C.(+)

**Operating Data**

Product Code	Diameter x Length (mm) / (inch)		Welding Current (A)	Weight g / 100 pcs
3010101906	3.20 x 350	1/8 x 14"	100 - 140	3700
3010101909	4.00 x 350	5/32 x 14"	140 - 180	5390

**Approvals:** CE, GOST-R, SEPRO

**Standards**

TS EN 14700	: E Fe 4
EN 14700	: E Fe 4
DIN 8555	: ~E 4-UM-60

**Chemical Composition of  
Weld Metal % (Typical)**

C	Mn	Si	Mo	Co	V	Cr
0.7	1.0	1.0	7.0	2.0	1.7	4.0

**Mechanical Properties**

<b>Hardness (HRC)</b>
56 - 60

**Features and Applications**

- Used in repairing of machining and cutting tools, tool bits, press dies and supports, fillers against strong abraision of excavating and detaching attachments
- Weld deposit has high resistance to friction and wear
- Re-drying : 300°C-350°C / 2h

**Welding Positions**

**Current Type**

D.C.(+) / A.C.

**Operating Data**

<b>Product Code</b>	<b>Diameter x Length (mm) / (inch)</b>		<b>Welding Current (A)</b>	<b>Weight g / 100 pcs</b>
3010101933	3.20 x 350	1/8 x 14"	80-110	4410
3010101936	4.00 x 350	5/32 x 14"	110-140	5960

**Approvals:** CE, GOST-R, SEPRO

**Standards**

TS EN 14700	: E Fe 14
EN 14700	: E Fe 14
DIN 8555	: E 10-UM-60 GRZ

**Chemical Composition of  
Weld Metal % (Typical)**

C	Mn	Si	Cr
3.2	0.5	1.0	29.0

**Mechanical Properties**

Hardness (HRC)
58 - 62

**Features and Applications**

- On parts primarily exposed to abrasion combined with light impact, such as conveyor screws, mixer blades and mud pumps
- Requirement of re-drying for 2 hours at the temperatures between 300°C and 350°C

**Welding Positions**

**Current Type**

D.C.(+)/ A.C.

**Operating Data**

Product Code	Diameter x Length (mm) / (inch)		Welding Current (A)	Weight g / 100 pcs
3010101942	3.20 x 350	1/8 x 14"	110 - 140	5080
3010101945	4.00 x 350	5/32 x 14"	170 - 200	7960
3010101948	5.00 x 350	3/16 x 14"	190 - 260	11400

**Approvals:** CE, GOST-R, SEPRO



**Standards**

TS EN 14700	: E Fe 16
EN 14700	: E Fe 16
DIN 8555	: ~ E 10-UM-60 GRZ

**Chemical Composition of  
Weld Metal % (Typical)**

C	Cr	Nb
6.5	24.0	7.5

**Mechanical Properties**

Hardness (HRC)
~ 62

**Features and Applications**

- On parts primarily exposed to abrasion combined with light impact, such as conveyor screws, mixer blades and sand pumps
- Weld metal has resistant to corrosion, friction and impact
- It is not recommended overlap passes
- Requirement of re-drying for minimum 2 hours at temperatures between 300°C and 350°C

**Welding Positions**

**Current Type**

D.C.(+) / A.C.

**Operating Data**

Product Code	Diameter x Length (mm) / (inch)		Welding Current (A)	Weight g / 100 pcs
3010101951	3.20 x 350	1/8 x 14"	125 - 160	5040
3010101954	4.00 x 350	5/32 x 14"	170 - 200	7710

**Approvals:** CE, GOST-R, SEPRO

### Standards

TS EN 14700	: E Z Fe 14
EN 14700	: E Z Fe 14
DIN 8555	: E 10-UM-60 GRZ
AWS A5.13	: ~E FeCr-A8

### Chemical Composition of Weld Metal % (Typical)

C	Cr	Si	Mn
4.5	34.0	1.0	0.5

### Mechanical Properties

Hardness (HRC)
60 -64

### Features and Applications

- Special coating, high-chromium carbide electrode for hardfacing operations to provide maximum resistance to extreme mineral abrasion
- A typical application is stringer beads on earth-moving, cement mill and brick making equipment
- Weld metal efficiency is ~ % 220.
- Re-drying : 300°C-350°C / min. 2h

### Welding Positions



### Current Type

D.C.(+)(-) / A.C.

### Operating Data

Product Code	Diameter x Length (mm) / (inch)		Welding Current (A)	Weight g / 100 pcs
3010101960	3.20 x 350	1/8 x 14"	125 - 160	5030
3010101963	4.00 x 350	5/32 Xx 14"	170 - 200	7420
3010101969	5.00 x 350	3/16 x14"	190 - 260	12000

**Approvals:** CE, GOST-R, SEPRO

**Standards**

TS EN 14700	: E Fe 16
EN 14700	: E Fe 16
DIN 8555	: E 10-UM-65 GRZ

**Chemical Composition of  
Weld Metal % (Typical)**

C	Mn	Si	Mo	V	W	Cr	Nb
4.5	0.3	1.0	5.0	1.7	2.5	23.5	4.0

**Mechanical Properties**

Hardness (HRC)
63 - 67

**Features and Applications**

- Super hardfacing electrode with very high content of carbide formers (Mo, V, W, Nb) for deposits subject to extreme sliding mineral abrasion
- Used in blast furnace cover mechanism, breakers, mixers, gimlet, non-steel and cement industry, mining coal industries, weld metal efficiency is ~ % 230
- Re-drying : 300°C-350°C / min. 2h

**Welding Positions**

**Current Type**

D.C.(+) / A.C.

**Operating Data**

Product Code	Diameter x Length (mm) / (inch)		Welding Current (A)	Weight g / 100 pcs
3010101975	3.20 x 350	1/8 x 14"	110 - 150	5500
3010101978	4.00 x 350	5/32 x 14"	170 - 200	8200
3010101981	5.00 x 350	3/16 x 14"	190 - 250	12500

**Approvals:** CE, GOST-R, SEPRO

**Standards**

TS EN ISO 14172	: E Ni 6625 (NiCr22Mo9Nb)
EN ISO 14172	: E Ni 6625 (NiCr22Mo9Nb)
AWS A5.11	: E NiCrMo-3

**Chemical Composition of  
Weld Metal % (Typical)**

C	Mn	Si	Mo	Ni	Fe	Cr	Ti	Nb
0.04	0.4	0.7	9.0	rest	5.0	21.0	+	3.5

**Mechanical Properties**

Yield Strength (N/mm <sup>2</sup> )	Tensile Strength (N/mm <sup>2</sup> )	Impact Strength		Elongation (L <sub>0</sub> =5d <sub>0</sub> ) (%)
		(ISO-V/+20°C)	(ISO-V/-196°C)	
min. 420	min. 760	min. 60 J	min. 35 J	min. 30

**Typical Base Material Grades**

- 1.4529 X2 NiCrMoCu 25 20 6
- 1.4583 X10 NiCrMoNb 1812
- 1.4876 X10 NiCrAlTi 32 20 (Incoloy800)
- 1.5662 X8 Ni 9 (ASTM 9Ni)
- 2.4816 NiCr 15 Fe (Inconel 600)
- 2.4856 NiCr 22 Mo 9 Nb (Inconel 625)
- 2.4858 NiCr 21 Mo (Inconel 825)
- 2.4951 NiCr20Ti (ASTM 75)
- 2.4952 NiCr 20 TLN (ASTM 80A)
- ASTM 8443, 8444, 8446 (UNS N06625)

**Features and Applications**

- High Molybdenum Nickel-base alloy electrode for creep-resistant steels, heat resisting steels, heat resisting and Cryogenic materials, dissimilar joints and high strength problem steels
- Especially designed for Inconel 625 and Incoloy 825
- Re-drying cond. : 250°C-300°C / 2h

**Welding Positions**

**Current Type**

D.C.(+)

**Operating Data**

Product Code	Diameter x Length (mm) / (inch)		Welding Current (A)	Weight g / 100 pcs
3010101986	2.50 x 250	3/32 x 10"	60 - 80	1600
3010101991	3.20 x 300	1/8 x 12"	70 - 100	3220
3010101996	4.00 x 350	5/32 x 14"	90 - 130	5460

**Approvals:** CE, GOST-R, SEPRO

**Standards**

TS EN ISO 14172	: E Ni 6082 (NiCr20Mn3Nb)
EN ISO 14172	: E Ni 6082 (NiCr20Mn3Nb)
AWS A5.11	: ~ E NiCrFe 3

**Chemical Composition of  
Weld Metal % (Typical)**

C	Mn	Si	Mo	Ni	Fe	Cr	Ti	Nb
0.05	4.5	0.4	1.5	>65	3.0	20.0	0.25	1.8

**Mechanical Properties**

Yield Strength (N/mm <sup>2</sup> )	Tensile Strength (N/mm <sup>2</sup> )	Impact Strength (ISO-V/+20°C)	Elongation (L <sub>0</sub> =5d <sub>0</sub> ) (%)
min. 390	630 - 710	min. 60 J	min. 30

**Typical Base Material Grades**

- Un-alloyed and alloyed, high temperature steels to X8Ni9, high alloyed Cr and CrNi Steels, particularly for mixed alloy joints. Nickel and nickel alloys and joints to steels.
- NiCr 15 Fe, LC-NiCr 15Fe, NiCr 60 15, INCONEL 600 / 600 L, INCOLOY 800

**Features and Applications**

- Resisting to low and high temperature and creep, low and unalloyed steels contain up to % 9 Ni Ni and Ni Alloys and pressure vessels
- Weld metal has non-scaling structure at -196°C and 1200°C
- Weld metal is stainless, austenitic steels and resistance to thermal shock

**Welding Positions**

**Current Type**

D.C.(+)

**Operating Data**

Product Code	Diameter x Length (mm) / (inch)		Welding Current (A)	Weight g / 100 pcs
3010102016	2.50 x 250	3/32 x 10"	50-80	1750
3010102021	3.20 x 300	1/8 x 12"	75-105	3350
3010102026	4.00 x 350	5/32 x 14"	90-130	5490

**Approvals:** CE, GOST-R , SEPRO, ABS

**Standards**

TS EN ISO 14172	: E Ni 6182 (NiCr15Fe6Mn)
EN ISO 14172	: E Ni 6182(NiCr15Fe6Mn)
AWSA5.11	: E NiCrFe3

**Chemical Composition of  
Weld Metal % (Typical)**

C	Mn	Si	Ni	Fe	Cr	Nb
0.04	7.5	0.6	rest	7.5	16.7	2.2

**Mechanical Properties**

Yield Strength (N/mm <sup>2</sup> )	Tensile Strength (N/mm <sup>2</sup> )	Impact Strength		Elongation (L <sub>0</sub> =5d <sub>0</sub> ) (%)
		(ISO-V/+20°C)	(ISO-V/-196°C)	
min. 360	min. 550	min. 47 J	min. 32 J	min. 30

**Typical Base Material Grades**

- NiCr 15 Fe, LC-NiCr 15 Fe, NiCr 60 15, INCONEL 600/600L, INCOLOY 800

**Features and Applications**

- This electrode is a Nickel-based and basic-type electrode
- Applicability in welding high-temperature steels and low-temperature alloyed or unalloyed steels, Nickel (Ni), and Ni-alloys
- High creep-resistance
- Serviceability at temperatures ranging between -196°C and 480°C
- Requirement of re-drying at 300°C-350°C for 2 hours

**Welding Positions**

**Current Type**

D.C.(+)

**Operating Data**

Product Code	Diameter x Length (mm) / (inch)		Welding Current (A)	Weight g / 100 pcs
3010102031	2.50 x 250	3/32 x 10"	50 - 80	1600
3010102036	3.20 x 300	1/8 x 12"	75 - 105	3250
3010102041	4.00 x 350	5/32 x 14"	90 - 130	5490

**Approvals:** CE, GOST-R, SEPRO

**Typical Base Material Grades**

- Non-alloyed and low alloyed steels, stainless steels, aluminium and aluminium alloys, copper and copper alloys, cast-iron and steel casts

**Features and Applications**

- Usability in cutting, in making welding grooves, or in drilling all metals that cannot be oxygen-cut or -drilled
- Resistance against high values of current at welding.
- Requirement of holding the electrode in the direction perpendicular to work direction

**Welding Positions**

**Current Type**  
 D.C.(-) / A.C.

**Operating Data**

Product Code	Diameter x Length (mm) / (inch)		Welding Current (A)	Weight g / 100 pcs
3010102044	3.20 x 350	1/8 x 14"	160 - 240	3680
3010102050	4.00 x 350	5/32 x 14"	180 - 300	5430
3010102053	4.00 x 450	5/32 x 18"	180 - 300	11000
3010102056	5.00 x 450	3/16 x 18"	240 - 400	15000

**Typical Base Material Grades**

- Non-alloyed and low alloyed steels, stainless steels, aluminium and aluminium alloys, copper and copper alloys, cast-iron and steel casts

**Features and Applications**

- Usability in making welding grooves, or in removing defective weld beads in all metals that cannot be worked through oxygen
- Very easy usage
- Arc start by holding the electrode in a direction perpendicular to that of the work, and, by subsequently pushing it forward after approaching it at an angle of 15° to work direction
- Groove depth of half of the electrodes coating thickness
- Deeper grooves obtained only by repeating the operation after the work piece is cooled

**Welding Positions**

**Current Type**  
 D.C.(+) / A.C.

**Operating Data**

Product Code	Diameter x Length (mm) / (inch)		Welding Current (A)	Weight g / 100 pcs
3010102059	3.20 x 350	1/8 x 14"	180 - 240	3770
3010102062	4.00 x 350	5/32 x 14"	250 - 320	5350
3010102065	5.00 x 350	3/16 x 14"	360 - 500	8280

**Approvals (ELIT CUT / NUT):** GOST-R, SEPRO



**WELDING WIRES**



**Standards**

TS EN ISO 14341-A	: G2Si
TS EN ISO 636-A	: W2Si
EN ISO 14341-A	: G2Si
EN ISO 636-A	: W2Si
AWS A5.18	: ER 70 S-3

**Chemical Composition of Welding Wire % (Typical)**

C	Si	Mn
0.10	0.6	1.2

**Mechanical Properties**

Yield Strength (N/mm <sup>2</sup> )	Tensile Strength (N/mm <sup>2</sup> )	Impact Strength (ISO-V/-30°C)	Elongation ((L <sub>0</sub> =5d <sub>0</sub> ) (%))
min. 400	480 - 600	min. 47 J	min. 22

**Typical Base Material Grades**

- S235J2G3-S355J2G3, P235T2-P355T2, L210NB - L290NB, L290MB-L360MB, P235G1TH, P255G1TH, P235GH P355GH, S235JRS1-S235J4S, S315G1S-S355G3S, P255NH-P355NH, GE200-GE300

**Features and Applications**

- Welding of thin walled parts
- Root pass welding
- For making galvanized coating
- TIG welding of tubes and pipes
- Shielding gases: TIG: Ar / MAG: 20% CO<sub>2</sub>, - 80% Ar or pure CO<sub>2</sub>

**Welding Positions**

**Current Type**

TIG D.C.(-) / MAG D.C.(+)

**Operating Data**

Product Code		Diameter x Length (mm) / (inch)		Weight (Kg)	Package Type
<b>BS 300</b>	<b>D 300</b>				BS/D/300
3010200009	3010200033	0.8	0.030"	15	D 200
3010200011	3010200035	1.0	0.040"	15	D 100
3010200013	3010200037	1.2	0.047"	15	ECO PACK
3010200014	3010200039	1.6	0.062"	15	BIG PACK
		(0,6,0,9, 1.14,1.4)		(1,5,15,18,50,250,400)	
	3010300115	1,60 x 1000	1/16 x 39"	5	Carton Box
	3010300116	2,00 x 1000	5/64 x 39"	5	
	3010300117	2,40 x 1000	3/32 x 39"	5	
	3010300118	3,20 x 1000	1/8 x 39"	5	
	3010300119	4,00 x 1000	5/32 x 39"	5	
	3010300120	5,00 x 1000	3/16 x 39"	5	

### Standards

TS EN ISO 14341-A	: G2Ti
TS EN ISO 636-A	: W2Ti
EN ISO 14341-A	: G2Ti
EN ISO 636-A	: W2Ti
AWS A5.18	: ER 70 S-2

### Chemical Composition of Welding Wire % (Typical)

C	Mn	Si	Zr	Ti	Al
0.05	1.1	0.55	0.07	0.12	0.11

### Mechanical Properties

Yield Strength (N/mm <sup>2</sup> )	Tensile Strength (N/mm <sup>2</sup> )	Impact Strength (ISO-V/-30°C)	Elongation ((L <sub>0</sub> =5d <sub>0</sub> ) (%))
min. 400	min. 480	min. 47 J	min. 22

### Typical Base Material Grades

- S235J2G3-S355J2G3, P235T2-P355T2, L210NB-L290NB, L290MB-L360MB, P235G1TH, P255G1TH, P235GH P355GH, S235JRS1-S235J4S, S315G1S-S355G3S, P255NH-P355NH, S255N-S420N, GE200-GE300

### Features and Applications

- Wire for welding mild and low alloy steels as well as thin walled materials
- Being triple deoxidized with Aluminium, Titanium and Zirconium as well as Manganese and Silicon, the wire is capable of producing efficient welds when the steel to be welded is rusty, dirty, undercoat painted
- It is recommended for pipe welding and for root passes in heavy vessel construction
- Also for welding of steels of which surface will be coated (such as galvanized, etc.)
- Shielding gases: MAG; Ar + CO<sub>2</sub> mix gases, TIG; %100 Ar gas can be used

### Welding Positions



### Current Type

TIG D.C.(-) / MAG D.C.(+)

### Operating Data

Product Code		Diameter x Length (mm) / (inch)		Weight (Kg)	Package Type
<b>BS 300</b>	<b>D 300</b>				
3010202833	3010202856	0.8	0.030"	15	BS/D/300
3010202835	3010202858	1.0	0.040"	15	D 200
3010202837	3010202860	1.2	0.047"	15	D 100
3010202838	3010202862	1.6	0.062"	15	ECO PACK
		(0,6,0,9,1,14,1,4)		(1,5,15,18,50,250,400)	BIG PACK
	3010300222	1,60 x 1000	1/16 x 39"	5	Carton Box
	3010300223	2,00 x 1000	5/64 x 39"	5	
	3010300224	2,40 x 1000	3/32 x 39"	5	
	3010300225	3,20 x 1000	1/8 x 39"	5	
	3010300226	4,00 x 1000	5/32 x 39"	5	
	3010300227	5,00 x 1000	3/16 x 39"	5	

Approvals: SG 70 S2 · TSE, CE, GOST-R, SEPRO

**Standards**

TS EN ISO 14341-A	: G3Si 1
TS EN ISO 636-A	: W3Si1
EN ISO 14341-A	: G3Si 1
EN ISO 636-A	: W3Si 1
AWS A5.18	: ER 70 S-6

**Chemical Composition of Welding Wire % (Typical)**

C	Si	Mn
0.08	0.85	1.45

**Mechanical Properties**

Yield Strength (N/mm <sup>2</sup> )	Tensile Strength (N/mm <sup>2</sup> )	Impact Strength (ISO-V/-30°C)	Elongation ((L <sub>0</sub> =5d <sub>0</sub> ) (%))
min. 420	500 - 640	min. 47 J	min. 22

**Typical Base Material Grades**

- E295, E335, S235J2G3-S355J2G3, P235T1-P355T1, P235T2,P355T2, L210NB-L415NB, L290MB-L360MB, P235G1TH, P255G1TH, P235GH-P355GH, S235JRS1-S235J4S, S315G1S-S355G3S, S255N-S380N,P255NH P355NH, GE200- GE260

**Features and Applications**

- Steel construction and machinery production
- Welding of ships, boiler tanks, pipe parts
- Welding of thin walled steels
- Thin sheet welding in automotive industry
- Perfect smooth feedability, perfect welding characteristics
- Shielding gases: MAG; Ar+CO<sub>2</sub> mix gases, TIG ; % 100 Ar gas can be used
- It can be used at operating temperatures of 350°C-400°C.

**Welding Positions**

**Current Type**

TIG D.C.(-) / MAG D.C.(+)

**Operating Data**

Product Code		Diameter x Length (mm) / (inch)		Weight (Kg)	Package Type
<b>BS 300</b>	<b>D 300</b>				BS/D 300
3010200449	3010200523	0.8	0.030"	15	D 200
3010200451	3010200525	1.0	0.040"	15	D 100
3010200453	3010200527	1.2	0.047"	15	ECO PACK
3010200454	3010200529	1.6	0.062"	15	BIG PACK
		(0,6,0,9, 1,14,1,4)		(1,5,15,18,50,250,400)	
	3010300156	1,60 x 1000	1 / 16 x 39"	5	Carton Box
	3010300157	2,00 x 1000	5/64 x 39"	5	
	3010300158	2,40 x 1000	3/32 x 39"	5	
	3010300159	3,20 x 1000	1/8 x 39"	5	
	3010300160	4,00 x 1000	5/32 x 39"	5	
	3010300161	5,00 x 1000	3/16 x 39"	5	

**Approvals:** **SG2[M24]:** BV, DNV-GL, TL, DB, ABS, LR, RS, RINA, NK, GOST-R, SEPRO, TÜV  
**SG2 [CO<sub>2</sub>]:** TSE, CE, GOST-R, DB **SG2 [TIG]:** BV, ABS, CE, DB, GOST-R, DNV-GL

### Standards

TS EN ISO 14341-A	: G4Si 1
TS EN ISO 636-A	: W4Si1
EN ISO 14341-A	: G4Si 1
EN ISO 636-A	: W4Si1
AWS A5.18	: ER 70 S-6

### Chemical Composition of Welding Wire % (Typical)

C	Si	Mn
0.10	1.0	1.70

### Mechanical Properties

Yield Strength (N/mm <sup>2</sup> )	Tensile Strength (N/mm <sup>2</sup> )	Impact Strength (ISO-V/-40°C)	Elongation ((L <sub>0</sub> =5d <sub>0</sub> ) (%))
min. 460	540- 680	min. 47 J	min. 22

### Typical Base Material Grades

- E295,E360,S235J2G3-S355J2G3, P235T1-P355T1, P235T2,P355T2, L210NB-L415NB, L290MB-L415MB, P235G1TH, P255G1TH, P235GH-P355GH, S235JRS1-S235J4S, S315G1S-S355G3S, S255N-S420N, P255NH-P420NH, GE200-GE260

### Features and Applications

- Used for the same welding purposes as SG2
- Its strength is increased by Si-Mn
- Low spatter although used under CO<sub>2</sub> atmosphere
- Excellent wire feeding capability
- Shielding gases: MAG; Ar+CO<sub>2</sub> mix gases, TIG; %100 Ar gas can be used

### Welding Positions



### Current Type

TIG D.C.(-) / MAG D.C.(+)

### Operating Data

Product Code		Diameter x Length (mm) / (inch)		Weight (Kg)	Package Type
<b>BS 300</b>	<b>D 300</b>				
3010201069	3010201107	0.8	0.030"	15	BS/D300 D 200
3010201071	3010201109	1.0	0.040"	15	D 100
3010201073	3010201111	1.2	0.047"	15	ECO PACK
3010201074	3010201113	1.6	0.062"	15	BIG PACK
		(0,6,0.9, 1.14,1.4)		(1,5,15,18,50,250,400)	
	3010300203	1.6 x 1000	1/16 x 39"	5	Carton Box
	3010300204	2.0 x 1000	5/64 x 39"	5	
	3010300205	2.4 x 1000	3/32 x 39"	5	
	3010300206	3.2 x 1000	1/8 x 39"	5	
	3010300207	4.0 x 1000	5/32 x 39"	5	

Approvals: **SG3 [M24]**: TSE, DB, TÜV, CE, DNV-GL, GOST-R, SEPRO

### Standards

TS EN ISO 21952-A	: G MoSi
EN ISO 21952-A	: G MoSi
TS EN ISO 21952-A	: W MoSi
EN ISO 21952-A	: W MoSi
AWS A5.28	: ER 80 S-G (mod.) (ER 70 S-A1)

### Chemical Composition of Welding Wire % (Typical)

C	Si	Mo	Mn
0.10	0.6	0.5	1.1

### Mechanical Properties

Yield Strength (N/mm <sup>2</sup> )	Tensile Strength (N/mm <sup>2</sup> )	Impact Strength (ISO-V/-20°C)	Elongation ((L <sub>0</sub> =5d <sub>0</sub> ) (%))
min. 460	550 - 670	min. 47 J	min. 22

### Typical Base Material Grades

- S355J2G3, L320-L415NB, L320MB-L415MB, P255G1TH, P235GH-P355GH, P255NH, 16Mo3, 17MnMoV6-4, 20MnMoNi5-5, 20MnMoNi4-5, GE240-GE300, 22Mo4, S255N-S460N, P255NH-P460 NH

### Features and Applications

- Copper coated wire for GMAW and rod TIG welding in boiler pressure vessel, pipework and crane construction as well as in structural steel engineering
- High quality, very tough deposit of high crack resistance and non-aging
- Recommended for service in temperature range (-40°C) for TIG, or (-20°C) for GMAW to (+550°C)
- Good copper bonding with low total copper content. Very good welding and flow characteristics
- Preheating interpass and postweld heat treatment as required by base metal
- Shielding gases: MAG; Ar+CO<sub>2</sub>, mix gases, TIG; %100 Ar

### Welding Positions



### Current Type

TIG D.C.(-) / MAG D.C.(+)

### Operating Data

Product Code		Diameter x Length (mm) / (inch)		Weight (Kg)	Package Type
<b>BS 300</b>	<b>D 300</b>				BS/D 300
3010201530	3010201557	0.8	0.030"	15	D 200
3010201532	3010201559	1.0	0.040"	15	D 100
3010201534	3010201561	1.2	0.047"	15	ECO PACK
3010201535	3010201563	1.6	0.062"	15	BIG PACK
		(0,6,0,9, 1,14,1,4)		(1,5,15,18,50,250,400)	
	3010300421	1,60 x 1000	1/16 x 39"	5	Carton Box
	3010300422	2,00 x 1000	5/64 x 69"	5	
	3010300423	2,40 x 1000	3/32 x 39"	5	
	3010300424	3,20 x 1000	1/8 x 39"	5	
	3010300425	4,00 x 1000	5/32 x 39"	5	

Approvals: SGMo: CE, GOST-R, SEPRO

### Standards

TS EN ISO 14341-A	: G 4Mo
EN ISO 14341-A	: G 4Mo
TS EN ISO 14341-A	: W 4Mo
EN ISO 14341-A	: W 4Mo
AWS A5.28	: ER 80 S-D2

### Chemical Composition of Welding Wire % (Typical)

C	Si	Mo	Mn
0.10	0.65	0.5	1.8

### Mechanical Properties

Yield Strength (N/mm <sup>2</sup> )	Tensile Strength (N/mm <sup>2</sup> )	Impact Strength (ISO-V/-30°C)	Elongation ((L <sub>0</sub> =5d <sub>0</sub> ) (%))
min. 470	550 - 680	min. 47 J	min. 20

### Typical Base Material Grades

- S355J2G3, L320-L415NB, L320MB-L415MB, P255G1TH, P235GH-P355GH, 16Mo3, 17MnMoV6-4, 20MnMoNi5-5, 20MnMoNi4-5, GE240-GE300, 22Mo4, S255N-S460N, P255NH-P460 NH

### Features and Applications

- Copper coated for GMAW and TIG welding in boiler pressure vessel, pipework and crane construction as well as in structural steel engineering
- High quality, very tough deposit of high crack resistance and non-aging
- Recommended for service in temperature range -45°C (TIG) or -40 °C (GMAW) to +550 °C.
- Good copper bonding with low total copper content
- Very good welding and flow characteristics
- Preheating interpass and postweld heat treatment as required by base metal
- Shielding gases: MAG; Ar+CO<sub>2</sub> mix gases, TIG; pure Ar gas can be used

### Welding Positions



### Current Type

TIG D.C.(-) / MAG D.C.(+)

### Operating Data

Product Code		Diameter x Length (mm) / (inch)		Weight (Kg)	Package Type
<b>BS 300</b>	<b>D 300</b>				BS/D/300
3010203050	3010203075	0.8	0.030"	15	D 200
3010203052	3010203077	1.0	0.040"	15	D 100
3010203054	3010203079	1.2	0.047"	15	ECO PACK
3010203055	3010203081	1.6	0.062"	15	BIG PACK
		(0,6,0,9, 1,14,1,4)		(1,5,15,18,50,250,400)	
	3010300281	1,60 x 1000	1/16 x 39"	5	Carton Box
	3010300282	2,00 x 1000	5/64 x 39"	5	
	3010300283	2,40 x 1000	3/32 x 39"	5	
	3010300284	3,20 x 1000	1/8 x 39"	5	
	3010300285	4,00 x 1000	5/32 x 39"	5	
	3010300286	5,00 x 1000	3/16 x 39"	5	

Approvals: SG80 S-D2 : CE, GOST-R, SEPRO

**Standards**

TS EN ISO 21952-A	: G Z CrMo 1 Si
EN ISO 21952-A	: G Z CrMo 1 Si
TS EN ISO 21952-A	: W Z CrMo1 Si
EN ISO 21952-A	: W Z CrMo1 Si
AWS A5.28	: ER 80 S-B2

**Chemical Composition of Welding Wire % (Typical)**

C	Si	Mn	Mo	Cr
0.10	0.6	0.5	0.5	1.2

**Mechanical Properties**

Yield Strength (N/mm <sup>2</sup> )	Tensile Strength (N/mm <sup>2</sup> )	Impact Strength (ISO-V/+20°C)	Elongation ((L <sub>0</sub> =5d <sub>0</sub> ) (%))	Heat Treatment
min. 470	550 - 670	min. 47 J	min. 19	620°C/1hour-300°C air

**Typical Base Material Grades**

- 13CrMo4-5, 15CrMo5, 42CrMo4, 16CrMoV4, 25CrMo4, 24CrMo5, G22CrMo5-4, G17CrMo5-5, A 333Gr, P11

**Features and Applications**

- Used for the welding of high heat resisting. Cr-Mo alloyed steels which are used for the production of boilers tubes and pipes and nitrided steels
- Weld metal is resistant to temperatures up to +570°C
- Shielding gases: MAG; Ar+CO<sub>2</sub> and Ar+ O<sub>2</sub> mix gases, TIG; pure Ar gas can be used

**Welding Positions**

**Current Type**

TIG D.C.(-) / MAG D.C.(+)

**Operating Data**

Product Code		Diameter x Length (mm) / (inch)		Weight (Kg)	Package Type
<b>BS 300</b>	<b>D 300</b>				BS/D/300
3010201750	3010201776	0.8	0.030"	15	D 200
3010201752	3010201778	1.0	0.040"	15	D 100
3010201754	3010201780	1.2	0.047"	15	ECO PACK
3010201755	3010201782	1.6	0.062"	15	BIG PACK
		(0,6,0,9, 1,14,1,4)		(1,5,15,18,50,250,400)	
3010300326		1,60 x 1000	1/16 x 39"	5	Carton Box
3010300327		2,00 x 1000	5/64 x 39"	5	
3010300328		2,40 x 1000	3/32 x 39"	5	
3010300329		3,20 x 1000	1/8 x 39"	5	
3010300330		4,00 x 1000	5/32 x 39"	5	

**Approvals:** CE, GOST-R, SEPRO

## Standards

TS EN ISO 21952-A	: G CrMo 1 Si
EN ISO 21952-A	: W CrMo 1 Si
TS EN ISO 21952-A	: G CrMo 1 Si
EN ISO 21952-A	: W CrMo 1 Si
AWSA5.28	: ER 80 S-G

## Chemical Composition of Welding Wire % (Typical)

C	Si	Mn	Mo	Cr
0.10	0.6	1.0	0.5	1.2

## Mechanical Properties

Yield Strength (N/mm <sup>2</sup> )	Tensile Strength (N/mm <sup>2</sup> )	Impact Strength (ISO-V/+20°C)	Elongation (L <sub>0</sub> =5d <sub>0</sub> ) (%)	Heat Treatment
min. 470	550 - 670	min. 47 J	min. 20	680°C/1hour-300°C air

## Typical Base Material Grades

- 13CrMo4-5, 15CrMo5, 42CrMo4, 16CrMoV4, 25CrMo4, 24CrMo5, G22CrMo5-4, G17CrMo5-5

## Features and Applications

- Used for the welding of high heat resisting. Cr-Mo alloyed steels which are used for the production of boilers tubes and pipes and nitrided steels
- Weld metal is resistant to temperatures up to +570°C
- Shielding gases: MAG; Ar+CO<sub>2</sub> and Ar+O<sub>2</sub> mix gases, TIG; pure Ar gas can be used

## Welding Positions

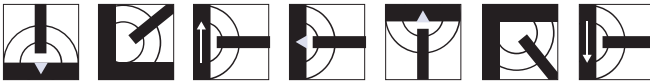

## Current Type

TIG D.C.(-) / MAG D.C.(+)

## Operating Data

Product Code		Diameter x Length (mm) / (inch)		Weight (Kg)	Package Type
<b>BS 300</b>	<b>D 300</b>				BS/D/300
3010201969	3010201992	0.8	0.030"	15	D 200
3010201971	3010201994	1.0	0.040"	15	D 100
3010201973	3010201996	1.2	0.047"	15	ECO PACK
3010201974	3010201998	1.6	0.062"	15	BIG PACK
		(0.6,0.9, 1.14, 1.4)		(1.5,15,18,50,250,400)	
	3010300360	1.6 x 1000	1/16 x 39"	5	Carton Box
	3010300361	2.0 x 1000	5/64 x 39"	5	
	3010300362	2.4 x 1000	3/32 x 39"	5	
	3010300363	3.2 x 1000	1/8 x 39"	5	
	3010300364	4.0 x 1000	5/32 x 39"	5	

Approvals: CE, GOST-R, SEPRO



## Standards

TS EN ISO 21952-A	: G Z CrMo 2 Si
EN ISO 21952-A	: G Z CrMo 2 Si
TS EN ISO 21952-A	: W Z CrMo 2 Si
EN ISO 21952-A	: W Z CrMo 2 Si
AWS A5.28	: ER 90 S-B3

## Chemical Composition of Welding Wire % (Typical)

C	Si	Mn	Mo	Cr
0.08	0.6	0.5	1.0	2.4

## Mechanical Properties

Yield Strength (N/mm <sup>2</sup> )	Tensile Strength (N/mm <sup>2</sup> )	Impact Strength (ISO-V/+20°C)	Elongation ((L <sub>0</sub> =5d <sub>0</sub> ) (%))	Heat Treatment
min. 540	620 - 760	min. 47 J	min. 20	690°C/1hour-300°C air

## Typical Base Material Grades

- 10 CrMo9-10, 10 CrSiMoV 7, 10 CrV 63, G-17 CrMo 9-10, A335 Gr. P22

## Features and Applications

- Used for the welding of high heat resisting
- XCr-Mo alloyed steels which are used for the production of boilers tubes, pipes and nitrided steels
- Weld metal is resistant to temperatures up to +600°C
- Shielding gases: MAG; Ar+CO<sub>2</sub> and Ar+O<sub>2</sub> mix gases, TIG; pure Ar gas can be used

## Welding Positions



## Current Type

TIG D.C.(-) / MAG D.C.(+)

## Operating Data

Product Code		Diameter x Length (mm) / (inch)		Weight (Kg)	Package Type
<b>BS 300</b>	<b>D 300</b>				BS/D/300
3010202185	3010202208	0.8	0.030"	15	D 200
3010202187	3010202210	1.0	0.040"	15	D 100
3010202189	3010202212	1.2	0.047"	15	ECO PACK
3010202190	3010202214	1.6	0.062"	15	BIG PACK
		(0,6,0,9, 1,14,1,4)		(1,5,15,18,50,250,400)	
	3010300367	1,60 x 1000	1/16 x 39"	5	Carton Box
	3010300368	2,00 x 1000	5/64 x 39"	5	
	3010300369	2,40 x 1000	3/32 x 39"	5	
	3010300370	3,20 x 1000	1/8 x 39"	5	
	3010300371	4,00 x 1000	5/32 x 39"	5	

Approvals: CE, GOST-R, SEPRO

### Standards

TS EN ISO 21952-A	: G CrMo 2 Si
EN ISO 21952-A	: W CrMo 2 Si
TS EN ISO 21952-A	: G CrMo 2 Si
EN ISO 21952-A	: W CrMo 2 Si
AWS A5.28	: ER 90 S-G

### Chemical Composition of Welding Wire % (Typical)

C	Si	Mn	Mo	Cr
0.08	0.6	1.0	1.0	2.4

### Mechanical Properties

Yield Strength (N/mm <sup>2</sup> )	Tensile Strength (N/mm <sup>2</sup> )	Impact Strength (ISO-V/+20°C)	Elongation ((L <sub>0</sub> =5d <sub>0</sub> ) (%))	Heat Treatment
min. 540	620 - 760	min. 47 J	min. 20	720°C/1hour-300°C air

### Typical Base Material Grades

- 10 CrMo9-10, 10 CrSiMoV 7, 10 CrV 63, G-17 CrMo 9-10, A 335 Gr. P22

### Features and Applications

- Used for the welding of high heat resisting
- XCr-Mo alloyed steels which are used for the production of boilers tubes, pipes and nitrided steels
- Weld metal is resistant to temperatures up to +600°C
- Shielding gases: MAG; Ar+CO<sub>2</sub> and Ar+O<sub>2</sub> mix gases, TIG; pure Ar gas can be used

### Welding Positions



### Current Type

TIG D.C.(-) / MAG D.C.(+)

### Operating Data

Product Code		Diameter x Length (mm) / (inch)		Weight (Kg)	Package Type
<b>BS 300</b>	<b>D 300</b>				BS/D/300
3010202401	3010202424	0.8	0.030"	15	D 200
3010202403	3010202426	1.0	0.040"	15	D 100
3010202405	3010202428	1.2	0.047"	15	ECO PACK
3010202406	3010202430	1.6	0.062"	15	BIG PACK
		(0.6,0.9, 1.14,1.4)		(1.5,15,18,50,250,400)	
	3010300400	1.6 x 1000	1/16 x 39"	5	Carton Box
	3010300507	2.0 x 1000	5/64 x 39"	5	
	3010300401	2.4 x 1000	3/32 x 39"	5	
	3010300402	3.2 x 1000	1/8 x 39"	5	
	3010300403	4.0 x 1000	5/32 x 39"	5	

Approvals: CE, GOST-R, SEPRO

**Standards**

TS EN ISO 21952-A	: G / W CrMo 5 Si
EN ISO 21952-A	: G / W CrMo 5 Si
AWS A5.28/(A5.9)	: ER 80 S-B6

**Chemical Composition of Welding Wire % (Typical)**

C	Si	Mn	Mo	Cr
0.07	0.45	0.5	0.6	6.0

**Mechanical Properties**

Yield Strength (N/mm <sup>2</sup> )	Tensile Strength (N/mm <sup>2</sup> )	Impact Strength (ISO-V/+20°C)	Elongation ((L <sub>0</sub> =5d <sub>0</sub> ) (%))	Heat Treatment
min. 470	min. 590	min. 70 J	min. 18	730-760°C/1h/300°C air

**Typical Base Material Grades**

- X12CrMo5, GX12CrMo5

**Features and Applications**

- Used for the welding of high heat resisting steels, hot hydrogen plants, working temperature is +600°C and also used for the welding of steels with 5 Cr 1/2 Mo
- Shielding gases: TIG: pure Ar gas can be used. MAG; Ar+CO<sub>2</sub>, and Ar+O<sub>2</sub> mix gases can be used

**Welding Positions**

**Current Type**

TIG D.C.(-) / MAG D.C.(+)

**Operating Data**

Product Code		Diameter x Length (mm) / (inch)		Weight (Kg)	Package Type
<b>BS 300</b>	<b>D 300</b>				BS/D/300
3010202617	3010202640	0.8	0.030"	15	D 200
3010202619	3010202642	1.0	0.040"	15	D 100
3010202621	3010202644	1.2	0.047"	15	EGO PACK
3010202622	3010202646	1.6	0.062"	15	BIG PACK
		(0,6,0,9, 1,14,1,4)		(1,5,15,18,50,250,400)	
	3010300404	1.6 x 1000	1/16 x 39"	5	Carton Box
	3010300405	2.0 x 1000	5/64 x 39"	5	
	3010300406	2.4 x 1000	3/32 x 39"	5	
	3010300407	3.2 x 1000	1/8 x 39"	5	
	3010300408	4.0 x 1000	5/32 x 39"	5	

**Approvals:** CE, GOST-R, SEPRO

**Standards**
**Chemical Composition of  
Welding Wire % (Typical)**

TS EN ISO 21952-A : W CrMo 91

EN ISO 21952-A : W CrMo 91

AWS A5.28/(A5.9) : ER 90 S-B9

C	Si	Mn	Mo	Cr	V	Ni	Nb	N
0.09	0.25	0.6	0.95	9.0	0.2	0.65	0.06	0.05

**Mechanical Properties**

Yield Strength (N/mm <sup>2</sup> )	Tensile Strength (N/mm <sup>2</sup> )	Impact Strength (ISO-V/+20°C)	Elongation ((L <sub>0</sub> =5d <sub>0</sub> ) (%))	Heat Treatment
650	740	min. 60 J	min. 18	745-775°C/1h/300°C air

**Typical Base Material Grades**

- X10CrMoVNb 9-1, A213 Gr. T91, A 335 Gr. P91 (T31), A 139 GR. T91, %9-12 Cr martensitic stainless steels.

**Features and Applications**

- Used for TIG welding of high heat resistance steels such as P91 / T91
- Power plants, turbines, oil refineries, coal and gasification plants, boiler production, also used for the welding of steels with 9Cr 1Mo
- Weld metal is resistant to working temperature up to 600°C
- Shielding gas (TIG): Pure Ar

**Welding Positions**

**Current Type**

TIG D.C.(-)

**Operating Data**

Product Code	Diameter x Length (mm) / (inch)		Weight (Kg)	Package Type
6011100368	2.00 x 1000	5/64 x 39"	5	Carton Box
6011100369	2.40 x 1000	3/32 x 39"	5	

**Approvals:** CE, GOST-R, SEPRO

### Standards

TS EN ISO 14341-A	: G3Ni 1
TS EN ISO 636A	: W3Ni1
EN ISO 14341-A	: G3Ni 1
EN ISO 636A	: W3Ni1
AWS A5.28	: ER 80S-Ni1

### Chemical Composition of Welding Wire % (Typical)

C	Si	Mn	Ni
0.08	0.65	1.10	1.0

### Mechanical Properties

Yield Strength (N/mm <sup>2</sup> )	Tensile Strength (N/mm <sup>2</sup> )	Impact Strength (ISO-V/-45°C)	Elongation (L <sub>0</sub> =5d <sub>0</sub> ) (%)
min. 470	min. 550	min. 27 J	min. 24

### Typical Base Material Grades

- A106; A515; A714; A131; A369; A210; L290; P235 T1 /T2; P275 T1;
- L360; L415; P275T2; P355N; API X-42; X46; X62; X60; P235GH; P355GH;
- A283; A285; A414; A372; A662; S275; S420; A516; A255; A333; A350; A612

### Features and Applications

- Building up of cranes, transport , industrial facilities, equipment in general, pipelines, shipbuilding, etc
- Working temperatures are between of -45°C and +400°C
- Shielding gas: Ar+CO<sub>2</sub> mix gases can be used for MAG
- Shielding gas: Ar gas can be used for TIG

### Welding Positions



### Current Type

TIG D.C.(-) / MAG D.C.(+)

### Operating Data

Product Code	Diameter x Length (mm) / (inch)		Weight (Kg)	Package Type
6031100120	1.20	0.047"	15	BS 300 Spool
6011100373	2.0 x 1.000	5/64 x 39"	5	Carton Box
6011100380	2.4 x 1.000	3/32 x 39"	5	Carton Box

Approvals: CE, GOST-R , SEPRO

**Standards**

TS EN ISO 14341-A	: G2Ni 2
EN ISO 14341-A	: G2Ni 2
AWS A5.28	: ER80S-Ni2

**Chemical Composition of  
Welding Wire % (Typical)**

C	Si	Mn	Ni
0.08	0.55	1.10	2.30

**Mechanical Properties**

Yield Strength (N/mm <sup>2</sup> )	Tensile Strength (N/mm <sup>2</sup> )	Impact Strength (ISO-V/-60°C)	Elongation ((L <sub>0</sub> =5d <sub>0</sub> ) (%))	Heat Treatment
min. 470	min. 550	min. 27 J	min. 24	620 ± 15°C / 1 hours

**Typical Base Material Grades**

- S255NL2-S355NL2; 14Ni6; 12Ni14; X12Ni5; S255N, S380N, S255NL, S380NL;  
S255NL1-S355NL1; S380NL1;
- A333: Gr.1-3; A442; Gr55-60; A334: Gr.3;
- 10Ni14, 13MnNi63 ; TTSI E355; TTSI E 460; HY 80; TTSE 35 N

**Features and Applications**

- Applications down to -60°C on mild steels, low-alloy steels and fine-grained steels, plates, storage tanks, pipelines and equipment for cryogenic use
- Shielding gas: Ar+CO<sub>2</sub> mix gases can be used

**Welding Positions**

**Current Type**

MAG D.C.(+)

**Operating Data**

Product Code	Diameter (mm) / (inch)		Weight (Kg)	Package Type
6031100312	1.20	0.047"	15	BS 300 Spool

**Approvals:** CE, SEPRO

## Standards

TS EN ISO 16834-A	: G 62 6 C1/M21 Mn3Ni1Mo
EN ISO 16834-A	: G 62 6 C1/M21 Mn3Ni1Mo
AWS A5.28	: ER 100 S-G

## Chemical Composition of Welding Wire % (Typical)

C	Si	Mn	Ni	Mo
0.09	0.65	1.70	1.15	0.40

## Mechanical Properties

Yield Strength (N/mm <sup>2</sup> )	Tensile Strength (N/mm <sup>2</sup> )	Impact Strength (ISO-V/-60°C)	Elongation ((L <sub>0</sub> =5d <sub>0</sub> ) (%))
min. 620	700 - 890	min. 47 J	min. 18

## Typical Base Material Grades

- P355NL1, P460NL1, StE460-590, USS-T.TTS, TE47-51, N-X-ATRA 70, WTSt37-2, WT37-3, WTSt52- 3
- WT St52-3A, Corten A, Patinax 37, Alcodur 50, Koralpin 52, S255, S550, A516, A350, A612, A255, A299, A333

## Features and Applications

- Fine-grained low alloy steels and also austempering steels for applications. Building up of cranes, transport, tanks, industrial facilities, equipment in general, pipelines, shipbuilding, etc
- If necessary, post-weld stress relief shall be heat treated at 560°C-600°C for 1 hour and left in the furnace for cooling down to 300°C
- Shielding gas: Ar+CO<sub>2</sub> mix gases can be used

## Welding Positions



## Current Type

MAG D.C.(+)

## Operating Data

Product Code	Diameter (mm) / (inch)		Weight (Kg)	Package Type
6031100218	1.20	0.047"	15	BS 300 Spool

Approvals: CE, GOST-R , SEPRO

**Standards**

TS EN ISO 16834-A	: G/W Mn3Ni1CrMo
EN ISO 16834-A	: G/W Mn3Ni1CrMo
AWS A5.28	: ER 100S-G

**Chemical Composition of Welding Wire % (Typical)**

C	Mn	Mo	Cr	Ni	Si
0.07	1.55	0.25	0.25	1.50	0.50

**Mechanical Properties**

Yield Strength (N/mm <sup>2</sup> )	Tensile Strength (N/mm <sup>2</sup> )	Impact Strength (ISO-V/-30°C)	Elongation ((L <sub>0</sub> =5d <sub>0</sub> ) (%))
min. 620	min. 690	min. 47 J	min. 18

**Typical Base Material Grades**

- S460N,S500N, S550NC, S500NL, N-A-XTRA 56-70,BHV 70, PAS700, HSM700, E 295-E 360

**Features and Applications**

- ER 100 SG is low alloyed and high strength GMAW wire
- It is used for joining of the high strength low alloy steels and the fine grained constructional steels
- It has high yield strength and impact toughness at low temperatures
- Shielding gases MAG: (Ar+% 15-25 CO<sub>2</sub>) / TIG: Ar

**Welding Positions**

**Current Type**

TIG D.C.(-) / MAG D.C.(+)

**Operating Data**

Product Code		Diameter x Length (mm) / (inch)		Weight (Kg)	Package Type
<b>BS 300</b>	<b>D 300</b>				
3010203273	3010203296	0.8	0.030"	15	BS/D/300
3010203275	3010203298	1.0	0.040"	15	D 200
3010203277	3010203300	1.2	0.047"	15	ECO PACK
3010203278	3010203302	1.6	0.062"	15	BIG PACK
		(0,6,0,9, 1,14,1,4)		(1,5,15,18,50,250,400)	
	3010300450	1,60 x 1000	1/16 x 39"	5	Carton Box
	3010300451	2,00 x 1000	5/64 x 39"	5	
	3010300452	2,40 x 1000	3/32 x 39"	5	
	3010300453	3,20 x 1000	1/8 x 39"	5	

Approvals: CE, SEPRO, GOST-R



**Standards**

TS EN ISO 16834-A	: G/W Mn4Ni2CrMo
EN ISO 16834-A	: G/W Mn4Ni2CrMo
AWS A5.28	: ER 110S-G

**Chemical Composition of Welding Wire % (Typical)**

C	Si	Mn	Mo	Ni	Cr	Cu
0.09	0.75	1.70	0.50	2.0	0.30	0.20

**Mechanical Properties**

Yield Strength (N/mm <sup>2</sup> )	Tensile Strength (N/mm <sup>2</sup> )	Impact Strength (ISO-V/-30°C)	Elongation ((L <sub>0</sub> =5d <sub>0</sub> ) (%))
min. 690	min. 760	min. 47 J	19

**Typical Base Material Grades**

- High strength structural steels and fine grained steels
- S690Q, L690M, N-A-XTRA 70, USS-T1, BH 70 V, HY 100, ASTM A514 Gr.F

**Features and Applications**

- ER 110 SG is low alloyed and high strength GMAW wire and GTAW rods
- It is used for joining of the high strength low alloy steels and the fine grained constructional steels with minimum yield strength of 690 N/mm<sup>2</sup>, especially Hardox and Weldox sheets
- Boilers, pressure vessels, pipelines, structure steels are the other application areas
- Weld metal has high impact and toughness at low temperatures
- Pre-heat can be according to the base material
- Shielding gases - MAG : (Ar+% 15-25 CO<sub>2</sub>) / TIG : (Ar)

**Welding Positions**

**Current Type**

MAG D.C.(+) / TIG D.C.(-)

**Operating Data**

Product Code		Diameter x Length (mm) / (inch)		Weight (Kg)	Package Type
<b>BS 300</b>	<b>D 300</b>				BS/D/300
3010203706	3010203729	0.8	0.030"	15	D 200
3010203708	3010203731	1.0	0.040"	15	D 100
3010203710	3010203733	1.2	0.047"	15	EGO PACK
3010203711	3010203735	1.6	0.062"	15	BIG PACK
		(0,6,0,9, 1,14,1,4)		(1,5,15,18,50,250,400)	
	3010300470	1,60 x 1000	1/16 x 39"	5	Carton Box
	3010300471	2,00 x 1000	5/64 x 39"	5	
	3010300472	2,40 x 1000	3/32 x 39"	5	

**Approvals:** CE, GOST-R, SEPRO

**Standards**
**Chemical Composition of  
Welding Wire % (Typical)**

TS EN ISO 16834-A	: G 89 4 M21 Mn4Ni2,5CrMo
EN ISO 16834-A	: G 89 4 M21 Mn4Ni2,5CrMo
AWS A5.28	: ER 120S-G

C	Si	Mn	Mo	Ni	Cr	Cu
0.10	0.55	1.70	0.50	2.50	0.30	0.20

**Mechanical Properties**

Yield Strength (N/mm <sup>2</sup> )	Tensile Strength (N/mm <sup>2</sup> )	Impact Strength (ISO-V/-40°C)	Elongation ((L <sub>0</sub> =5d <sub>0</sub> ) (%))
min. 890	940 - 1180	min. 47 J	min. 15

**Typical Base Material Grades**

- S890QL , P460NH , P460NL1,
- WELDOX 900, StE 960, S960Q

**Features and Applications**

- Fine grained steels, high yield strength, austempering steels excellent properties low temperatures
- Lifting and handling machines, bridges, tanks, transport, shipbuilding, railway sector, mines, cranes, frames, etc
- Shielding gas: Ar+CO<sub>2</sub> mix gases can be used

**Welding Positions**

**Current Type**

MAG D.C.(+)

**Operating Data**

Product Code	Diameter (mm) / (inch)		Weight (Kg)	Package Type
6031100383	1.00	0.040"	15	BS 300 Spool
6031100382	1.20	0.047"	15	

**Approvals:** CE, SEPRO

**Standards**

TS EN ISO 14341-A	: ~G3Ni 1
EN ISO 14341-A	: ~G3Ni 1
AWS A5.28	: ER80S-G

**Chemical Composition of  
Welding Wire % (Typical)**

C	Si	Mn	Ni	Cu	Cr
0.08	0.80	1.30	0.80	0.40	0.20

**Mechanical Properties**

Yield Strength (N/mm <sup>2</sup> )	Tensile Strength (N/mm <sup>2</sup> )	Impact Strength		Elongation ((L <sub>0</sub> =5d <sub>0</sub> ) (%))
		(ISO-V/-20°C)	(ISO-V/-40°C)	
510	590	110 J	60 J	25

**Typical Base Material Grades**

- S235JRW, S235J2G3, Patinax 37, Alcodur 50, Korpalpin 52, S355J2G3Cu, 9CrNiCuP3-2-4, Corten A-B1, Itacor, WTSt37, WTST52.3, S355K2W

**Features and Applications**

- Excellent resistance to atmospheric events due to the presence of Cu, Cr, Ni
- Suitable for bridges, cranes, ground moving machines, boilers, building structures, petrochemical sector, fans gas pipes, fume section, etc
- Shielding gas: Ar+CO<sub>2</sub> mix gases can be used
- Depending on the thickness of the main material to be used, a pre-heating application can be applied to the main material before starting the welding.

**Welding Positions**

**Current Type**

MAG D.C.(+)

**Operating Data**

Product Code	Diameter (mm) / (inch)		Weight (Kg)	Package Type
6031100122	1.20	0.047"	15	BS 300 Spool

**Approvals:** CE, GOST-R , SEPRO

**Standards**

TS EN ISO 14343-A	: G 18 8 Mn
EN ISO 14343-A	: G 18 8 Mn
TS EN ISO 14343-A	: W 18 8 Mn
EN ISO 14343-A	: W 18 8 Mn
AWS A5.9	: ~ER 307

**Chemical Composition of  
Welding Wire % (Typical)**

C	Si	Mn	Cr	Ni
0.08	0.9	7.0	19.2	9.0

**Mechanical Properties**

Yield Strength (N/mm <sup>2</sup> )	Tensile Strength (N/mm <sup>2</sup> )	Impact Strength (ISO-V/+20°C)	Elongation ((L <sub>0</sub> =5d <sub>0</sub> ) (%))
min. 370	580 - 750	min. 63 J	min. 30

**Features and Applications**

- Filler welding of high-strength low-alloyed and alloyed heat-treatable steels, armor steels, steels including 14 % Mn, ferritic chromium steels, heat-resistant steels, non-magnetic steels etc.
- Joint welding of different types of steels with each other
- Filler welding of abrasion-resistant steels for valves and turbines
- As shielding gas, Argon is used at TIG welding, where as Ar+ % 2.5 O<sub>2</sub> or Ar+ % 2.5 CO<sub>2</sub> mixed gas is used at MIG welding

**Welding Positions**

**Current Type**

MIG DC(+) / TIG DC(-)

**Operating Data**

Product Code	Diameter x Length (mm) / (inch)		Weight (Kg)	Package Type
6011100313	0,8	0.030"	12.5	BS 300
6011100381	1	0.040"	15	BS 300
6011100314	1,2	0.047"	15	BS 300
6011100312	1,6	0.062"	15	BS 300
6011100315	2,00 x 1000	5/64 x 39"	5	Plastic Box
6011100316	2,40 x 1000	3/32 x 39"	5	Plastic Box
6011100317	3,20 x 1000	1/8 x 39"	5	Plastic Box

**Approvals:** GOST-R, SEPRO, DB

### Standards

TS EN ISO 14343-A	: W 19 9 H
EN ISO 14343-A	: W 19 9 H
AWS A5.9	: ER 308 H

### Chemical Composition of Welding Wire % (Typical)

C	Si	Mn	Cr	Ni
0.06	0.5	1.7	20.1	9.8

### Mechanical Properties

Yield Strength (N/mm <sup>2</sup> )	Tensile Strength (N/mm <sup>2</sup> )	Impact Strength (ISO-V/0°C)	Elongation ((L <sub>0</sub> =5d <sub>0</sub> ) (%))
min. 350	min. 550	min. 63 J	min. 25

### Typical Base Material Grades

- X2 CrNi 19 11, X5 CrNi 19 11, X 5 CrNi 18 8, X 12 CrNi 17 7, X 12 CrNi 18 8, G-X 10 CrNi 18 8, G-X 12 CrNi 18 8
- AISI: 304 L, 301,302,304,308

### Features and Applications

- Applicability in welding tempered high-strength steels as well as stainless steels, carbon steels, and 18/8, Cr-Ni -alloy steels
- Requirement of use of Ar as “shielding gas for TIG welding”

### Welding Positions



### Current Type

TIG D.C.(-)

### Operating Data

Product Code	Diameter x Length (mm) / (inch)		Weight (Kg)	Package Type
6011100318	2.0 x 1000	5/64 x 39”	5	Plastic Box
6011100319	2.4 x 1000	3/32 x 39”	5	Plastic Box
6011100320	3.2 x 1000	1/8 x 39”	5	Plastic Box

Approvals: GOST-R , SEPRO

### Standards

TS EN ISO 14343-A	: W 19 9 L
EN ISO 14343-A	: W 19 9 L
AWS A5.9	: ER 308 L

### Chemical Composition of Welding Wire % (Typical)

C	Si	Mn	Cr	Ni
0.02	0.5	1.7	20.1	9.8

### Mechanical Properties

Yield Strength (N/mm <sup>2</sup> )	Tensile Strength (N/mm <sup>2</sup> )	Impact Strength (ISO-V/+20°C)	Elongation ((L <sub>0</sub> =5d <sub>0</sub> ) (%))
min. 390	540 - 660	min. 63 J	min. 35

### Typical Base Material Grades

- X2CrNi 19 11, X5CrNi 18 10, X6CrNiTi 18 10, X6CrNiNb 18 10, X2CrNiN 18 10, X10CrNiNb 18 10
- AISI & ASTM: 304, 304L, 304LN, 347, 321, A320Gr.B8C, A320Gr.B8D

### Features and Applications

- TIG welding of 13% Cr ferritic stainless steels, high-carbon steels of type 304, or stabilized steels of type 347, or steels of similar qualities, all of which used in drug, cellulose, paper and food (production) industries
- The shielding gas is Argon (Ar).
- Maintenance of ductile behavior at temperature values down to -196°C
- Maintenance of resistance against intergranular corrosion at temperatures up to 400°C

### Welding Positions



### Current Type

TIG D.C.(-)

### Operating Data

Product Code	Diameter x Length (mm) / (inch)		Weight (Kg)	Package Type
6011100326	1.6 x 1000	1/16 x 39"	5	Plastic Box
6011100327	2.0 x 1000	5/64 x 39"	5	Plastic Box
6011100328	2.4 x 1000	3/32 x 39"	5	Plastic Box
6011100329	3.2 x 1000	1/8 x 39"	5	Plastic Box

Approvals: GOST-R, CE, SEPRO

### Standards

TS EN ISO 14343-A	: G 19 9 L Si
EN ISO 14343-A	: G 19 9 L Si
AWS A5.9	: ER 308 LSi

### Chemical Composition of Welding Wire % (Typical)

C	Si	Mn	Cr	Ni
0.02	0.8	1.7	20.4	10.2

### Mechanical Properties

Yield Strength (N/mm <sup>2</sup> )	Tensile Strength (N/mm <sup>2</sup> )	Impact Strength (ISO-V/+20°C)	Elongation ((L <sub>0</sub> =5d <sub>0</sub> ) (%))
min. 350	520 - 660	min. 63 J	min. 35

### Typical Base Material Grades

- X2 CrNi 19 11, X5CrNi 18 10, X6 CrNiTi 18 10, X6 CrNiNb 18 10, X2 CrNiN 18 10, X10 CrNiNb 18 10
- AISI & ASTM: 304, 304L, 304LN, 321, 347, A320Gr.B8C, A320Gr.B8D

### Features and Applications

- MIG welding of 13% Cr ferritic stainless steels, high-carbon steels of type 304 or stabilized steels of type 347, or steels of similar types, used in industries of drug, cellulose, paper, and food (production)
- Ar+%2.5O<sub>2</sub> or Ar+%2.5CO<sub>2</sub> mixed gas is used as shielding gas
- Maintenance of ductile behavior at temperature values down to -196°C.
- Maintenance of resistance to intergranular corrosion at temperatures up to 350°C

### Welding Positions



### Current Type

MIG D.C.(+)

### Operating Data

Product Code	Diameter (mm) / (inch)		Weight (Kg)	Package Type
6011100323	0.8	0.030"	12.5	BS 300
6011100324	1.0	0.040"	15	BS 300
6011100382	1.2	0.047"	15	BS 300
6011100322	1.6	0.062"	15	BS 300

Approvals: GOST-R , CE, SEPRO

### Standards

TS EN ISO 14343-A	: W 23 12 L
EN ISO 14343-A	: W 23 12 L
AWS A5.9	: ER 309 L

### Chemical Composition of Welding Wire % (Typical)

C	Si	Mn	Cr	Ni
0.03	0.45	1.80	23.5	13.0

### Mechanical Properties

Yield Strength (N/mm <sup>2</sup> )	Tensile Strength (N/mm <sup>2</sup> )	Impact Strength (ISO-V/+20°C)	Elongation ((L <sub>0</sub> =5d <sub>0</sub> ) (%))
min. 320	min. 520	min. 47 J	min. 30

### Typical Base Material Grades

- Ferritic Cr and austenitic CrNi steels, austenitic manganese steels, unalloyed high strength steels, high temperature steels

### Features and Applications

- Applicability on ferritic Cr or austenitic CrNi steels, austenitic manganese steels, unalloyed high-strength steels, heat-treated steels
- Usability in welding austenitic stainless steels, in joint-welding of different kinds of metals, in buffer layers, in joint-welding of corrosion-resistant stainless steels to each other or to low-alloyed steels, and in welding coated steels
- Requirement of use of Ar as shielding gas

### Welding Positions



### Current Type

TIG D.C.(-)

### Operating Data

Product Code	Diameter x Length (mm) / (inch)		Weight (Kg)	Package Type
6011100333	1.6 x 1000	1/16 x 39"	5	Plastic Box
6011100334	2.0 x 1000	5/64 x 39"	5	Plastic Box
6011100335	2.4 x 1000	3/32 x 39"	5	Plastic Box
6011100396	3.2 x 1000	1/8 x 39"	5	Plastic Box

Approvals: GOST-R, CE, SEPRO



**Standards**

TS EN ISO 14343-A	: G 23 12 L Si
EN ISO 14343-A	: G 23 12 L Si
AWS A5.9	: ER 309 L Si

**Chemical Composition of  
Welding Wire % (Typical)**

C	Si	Mn	Cr	Ni
0.03	0.80	1.80	23.5	13.0

**Mechanical Properties**

Yield Strength (N/mm <sup>2</sup> )	Tensile Strength (N/mm <sup>2</sup> )	Impact Strength (ISO-V/+20 °C)	Elongation (L <sub>0</sub> =5d <sub>0</sub> ) (%)
min. 320	min. 520	min. 47 J	min. 30

**Typical Base Material Grades**

- Ferritic Cr and austenitic CrNi steels, austenitic manganese steels, unalloyed high strength steels, high temperature steels.

**Features and Applications**

- Applicability on ferritic Cr or austenitic CrNi steels, austenitic manganese steels, unalloyed high-strength steels, heat-treated steels
- Usability in welding austenitic stainless steels, in joint- welding of different kinds of metals, in buffer layers, in joint-welding of corrosion-resistant stainless steels to each other or to low-alloyed steels, and in welding coated steels
- Ar+ %2.5 O<sub>2</sub> or (Ar+%2.5 CO<sub>2</sub>) gas is used as shielding gas

**Welding Positions**

**Current Type**

MIG D.C.(+)

**Operating Data**

Product Code	Diameter (mm) / (inch)		Weight (Kg)	Package Type
6011100383	0.8	0.030"	12.5	BS 300
6011100331	1.0	0.040"	15	BS 300
6011100332	1.2	0.047"	15	BS 300

**Approvals:** GOST-R , CE, SEPRO

**Standards**

TS EN ISO 14343-A	: G 25 20
EN ISO 14343-A	: G 25 20
TS EN ISO 14343-A	: W 25 20
EN ISO 14343-A	: W 25 20
AWS A5.9	: ER 310

**Chemical Composition of  
Welding Wire % (Typical)**

C	Si	Mn	Cr	Ni
0.12	0.5	1.6	25.0	20.5

**Mechanical Properties**

Yield Strength (N/mm <sup>2</sup> )	Tensile Strength (N/mm <sup>2</sup> )	Impact Strength (ISO-V/+20°C)	Elongation (L <sub>0</sub> =5d <sub>0</sub> ) (%)
min. 350	550 - 720	min. 63 J	min. 30

**Typical Base Material Grades**

- X15CrNiSi 25 20, X12CrNi 25 21, X15CrNi 20 12, G-X15CrNi 25 20, G-X40 CrNi 25 21, X10CrAl 7, X10CrAl 18, X10CrAl 24, 305, 310, 314, A297 HF, A297 HJ

**Features and Applications**

- Applicability in cement and ceramic industries, in manufacturing processes of industrial furnaces, oil refineries, in welding of steel and steel castings used in steam boiler manufacturing
- Suitability of weld metal for use at temperatures between -196°C and 1200°C
- Suitability for both TIG and MIG welding
- Requirement of use of Ar as shielding gas in TIG welding, and of Ar+ %2.5 O<sub>2</sub> or Ar+ %2.5 CO<sub>2</sub> mixed gas as shielding in MIG welding

**Welding Positions**

**Current Type**

TIG D.C.(-) / MIG D.C.(+)

**Operating Data**

Product Code	Diameter x Length (mm) / (inch)		Weight (Kg)	Package Type
6011100402	0,8	0.030"	12.5	BS 300
6011100338	1	0.040"	15	BS 300
6011100374	1,2	0.047"	15	BS 300
6011100339	1,60 x 1000	1/16 x 39"	5	Plastic Box
6011100340	2,00 x 1000	5/64 x 39"	5	Plastic Box
6011100341	2,40 x 1000	3/32 x 39"	5	Plastic Box
6011100342	3,20 x 1000	1/8 x 39"	5	Plastic Box

**Approvals:** GOST-R, CE, SEPRO

**Standards**

TS EN ISO 14343-A	: G 29 9
EN ISO 14343-A	: G 29 9
TS EN ISO 14343-A	: W 29 9
EN ISO 14343-A	: W 29 9
AWS A5.9	: ER 312

**Chemical Composition of  
Welding Wire % (Typical)**

C	Si	Mn	Cr	Ni
0.12	0.40	1.80	30.0	9.0

**Mechanical Properties**

Yield Strength (N/mm <sup>2</sup> )	Tensile Strength (N/mm <sup>2</sup> )	Impact Strength (ISO-V/+20°C)	Elongation ((L <sub>0</sub> =5d <sub>0</sub> ) (%))
min. 450	min. 660	47 J	min. 20

**Typical Base Material Grades**

DIN:	G-X	AISI:
X7Cr13	G-X 7 Cr 13	403
X7CrAl13	G-X 20 Cr 14	405
X10CrAl13	G-X 10 Cr Mo 13	410
X 8 Cr17	G-X 8 Cr Ni 13	420
X20Cr13		430
X 15Cr 13		430 Ti
X22CrNi17		431
X15CrNi134		446
X 8 Cr Ti 17		

**Features and Applications**

- Applicability in joint- welding of unalloyed and alloyed high-strength steels, Cr and Mn steels, tool steels, and of different metals
- Resistance to wearing, cracking and corrosion
- Requirement of use of Ar as shielding gas in TIG welding, and Ar+ %2.5 O<sub>2</sub> or Ar+ %2.5 CO<sub>2</sub> mix as shield gas in MIG welding

**Welding Positions**

**Current Type**

TIG D.C.(-) / MIG D.C.(+)

**Operating Data**

Product Code	Diameter x Length (mm) / (inch)		Weight (Kg)	Package Type
6011100153	0,8	0.030"	15	BS 300
6011100343	1	0.040"	15	BS 300
6011100156	1,2	0.047"	15	BS 300
6011100157	1,60 x 1000	1/16 x 39"	5	Plastic Box
6011100344	2,00 x 1000	5/64 x 39"	5	Plastic Box
6011100345	2,40 x 1000	3/32 x 39"	5	Plastic Box

**Approvals:** GOST-R , CE, SEPRO

### Standards

TS EN ISO 14343-A	: W Z 19 12 3 L
EN ISO 14343-A	: W Z 19 12 3 L
AWS A5.9	: ER 316 L

### Chemical Composition of Welding Wire % (Typical)

C	Si	Mn	Mo	Cr	Ni
0.02	0.5	1.6	2.2	18.5	11.5

### Mechanical Properties

Yield Strength (N/mm <sup>2</sup> )	Tensile Strength (N/mm <sup>2</sup> )	Impact Strength (ISO-V/+20°C)	Elongation ((L <sub>0</sub> =5d <sub>0</sub> ) (%))
min. 420	570 - 700	min. 63 J	min. 30

### Typical Base Material Grades

- X2 CrNiMo 1814 3, XS CrNiMo 1713 3, X2 CrNiMo 1713 2, XS CrNiMoTi 1712 2, X6 CrNiMoTi 1712 2, X6 CrNiMoNb 1712 2, X2 CrNiMoN 1713 3, X2 CrNiMoN 1712 2
- AISI: 316, 316L, 316Cb, 316Ti

### Features and Applications

- TIG welding of 13% Cr ferritic stainless steels, high-carbon or stabilized steels of type 316, low-carbon stainless steels of type 316 L, all of which are used in machinery and equipment parts at production plants for food, chemical, drug textile and similar kinds of industries
- As shielding gas, Argon (Ar) is used
- Maintenance of resistance to intergranular corrosion at temperature valves up to 400°C.
- Resistance to low temperatures varying at values down to -196°C

### Welding Positions



### Current Type

TIG D.C.(-)

### Operating Data

Product Code	Diameter x Length (mm) / (inch)		Weight (Kg)	Package Type
6011100351	1,60 x 1000	1/16 x 39"	5	Plastic Box
6011100400	2,00 x 1000	5/64 x 39"	5	Plastic Box
6011100352	2,40 x 1000	3/32 x 39"	5	Plastic Box

Approvals: GOST-R, CE, SEPRO

### Standards

TS EN ISO 14343-A	: G Z 19 12 3 L Si
EN ISO 14343-A	: G Z 19 12 3 L Si
AWS A5.9	: ER 316 LSi

### Chemical Composition of Welding Wire % (Typical)

C	Si	Mn	Cr	Ni	Mo
0.02	0.80	1.6	18.5	11.5	2.2

### Mechanical Properties

Yield Strength (N/mm <sup>2</sup> )	Tensile Strength (N/mm <sup>2</sup> )	Impact Strength (ISO-V/+20°C)	Elongation ((L <sub>0</sub> =5d <sub>0</sub> ) (%))
min. 400	550 - 700	min. 63 J	min. 30

### Typical Base Material Grades

- X2 CrNiMo 1814 3, X5 CrNiMo 17 13 3, X2 CrNiMo 1713 2, , X5 CrNiMo 1712 2, X6 CrNiMoTi 12 2, X6 CrNiMoNb 17 12 2, X2 CrNiMoN 1713 3, X2 CrNiMoN 1712 2
- AISI: 316, 316Cb, 316L, 316Ti

### Features and Applications

- MIG welding of 13% ferritic stainless steels, high-carbon or stabilized stainless steels of type 316 and low carbon stainless steels of type 316 L, used in machinery and equipment parts of production plants for food, chemical, drug, textile and similar kinds of industries
- As shielding gas, Ar+ %2.5 O<sub>2</sub> or Ar+ %2.5 CO<sub>2</sub> mixed gas is used
- Maintenance of resistance to intergranular corrosion at temperature values up to 400°C.
- Resistance to low temperatures varying at values down to -196°C

### Welding Positions



### Current Type

MIG D.C.(+)

### Operating Data

Product Code	Diameter (mm) / (inch)		Weight (Kg)	Package Type
	mm	inch		
6011100348	0,8	0.030"	12.5	BS 300
6011100398	1	0.040"	15	BS 300
6011100349	1,2	0.047"	15	BS 300
6011100350	1,6	0.062"	15	BS 300

Approvals: GOST-R , CE, SEPRO

### Standards

TS EN ISO 14343-A	: W 19 12 3 Nb
EN ISO 14343-A	: W 19 12 3 Nb
AWSA5.9	: ER 318

### Chemical Composition of Welding Wire % (Typical)

C	Si	Mn	Cr	Ni	Mo	Nb
0.035	0.50	1.7	19.6	11.4	2.7	+

### Mechanical Properties

Yield Strength (N/mm <sup>2</sup> )	Tensile Strength (N/mm <sup>2</sup> )	Impact Strength (ISO-V/+20°C)	Elongation ((L <sub>0</sub> =5d <sub>0</sub> ) (%))
min. 440	640 - 780	min. 63 J	min. 30

### Typical Base Material Grades

- X6 CrNiMoTi 1712 2, X6 CrNiMoNb 1712 2, X5 CrNiMo 1712 2, G-X5 CrNiMoNb 18 10, X10 CrNiMoNb 18 12
- AISI: 316, 316Cb, 316L, 316Ti

### Features and Applications

- TIG welding of 13% ferritic stainless steels as well as of stainless steels of similar chemical compositions as those of welding wires used in chemical, textile, paint, food and synthetic resin production
- As the shielding gas, argon(Ar) is used
- Maintenance of resistance to intergranular corrosion at temperature values up to 400 °C

### Welding Positions



### Current Type

TIG D.C.(-)

### Operating Data

Product Code	Diameter x Length (mm) / (inch)		Weight (Kg)	Package Type
6011100401	1.6 x 1000	1/16 x 39"	5	Plastic Box
6011100356	2.0 x 1000	5/64 x 39"	5	Plastic Box
6011100180	2.4 x 1000	3/32 x 39"	5	Plastic Box

Approvals: GOST-R, CE, SEPRO

**Standards**

TS EN ISO 14343-A	: G 19 12 3 Nb Si
EN ISO 14343-A	: G 19 12 3 Nb Si
AWS A5.9	: ~ER 318

**Chemical Composition of  
Welding Wire % (Typical)**

C	Si	Mn	Cr	Ni	Mo	Nb
0.035	0.8	1.4	19.9	11.5	2.8	+

**Mechanical Properties**

Yield Strength (N/mm <sup>2</sup> )	Tensile Strength (N/mm <sup>2</sup> )	Impact Strength (ISO-V/+20°C)	Elongation ((L <sub>0</sub> =5d <sub>0</sub> ) (%))
min. 390	600 - 780	min. 63 J	min. 30

**Typical Base Material Grades**

- X6 CrNiMoTi 1712 2, X6 CrNiMoNb 1712 2, X5 CrNiMo 1712 2, G-X5 CrNiMoNb 1810, G-X10 CrNiMo 18 10, X10 CrNiNb 1810, X10 CrNiMoNb 1812
- AISI: 316, 316Cb, 316L, 316Ti

**Features and Applications**

- Used for the welding of 13% ferritic stainless steels or stainless steels which have the similar chemical analysis to welding wires that are used in the chemical, textile, paint and food industries
- Weld metal is resistant to corrosion up to +400°C and chlorine
- Suitable for MIG welding
- Ar+ %2.5 O<sub>2</sub> or Ar+ %2.5 CO<sub>2</sub> mixed gases are the shielding gases.

**Welding Positions**

**Current Type**

MIG D.C.(+)

**Operating Data**

Product Code	Diameter (mm) / (inch)		Weight (Kg)	Package Type
6011100357	1.0	0.040"	15	BS 300
6011100406	1.2	0.047"	15	BS 300

**Approvals:** GOST-R, CE, SEPRO

### Standards

TS EN ISO 14343-A	: W 19 9 Nb
EN ISO 14343-A	: W 19 9 Nb
AWS A5.9	: ER 347

### Chemical Composition of Welding Wire % (Typical)

C	Si	Mn	Cr	Ni	Nb
0.035	0.5	1.4	19.4	9.5	+

### Mechanical Properties

Yield Strength (N/mm <sup>2</sup> )	Tensile Strength (N/mm <sup>2</sup> )	Impact Strength (ISO-V/+20°C)	Elongation ((L <sub>0</sub> =5d <sub>0</sub> ) (%))
min. 430	600 - 740	min. 63 J	min. 30

### Typical Base Material Grades

- X6 CrNiNb 18 10, X6 CrNiTi 18 10, G-X5 CrNiNb 18 9, X-5 CrNi 18 10, G-X10 CrNi 18 8, X12 CrNiTi 18 9, X10 CrNiNb 1810
- AISI & ASTM: 304, 321, 347, A157Gr.C9, A296Gr.CF8C, A320Gr.B8C, A320Gr.B8D

### Features and Applications

- Used for the welding of 13% Cr steels which are used in the textile, paper, paint and food industries
- Resistant to corrosion up to +400°C, suitable for TIG welding
- Argon is the shielding gas and it is also used for the welding of materials which have the similar chemical composition to welding wire

### Welding Positions



### Current Type

TIG D.C.(-)

### Operating Data

Product Code	Diameter x Length (mm) / (inch)		Weight (Kg)	Package Type
6011100360	1.6 x 1000	1/16 x 39"	5	Plastic Box
6011100361	2.0 x 1000	5/64 x 39"	5	Plastic Box
6011100362	2.4 x 1000	3/32 x 39"	5	Plastic Box
6011100363	3.2 x 1000	1/8 x 39"	5	Plastic Box

Approvals: GOST-R, CE, SEPRO



### Standards

TS EN ISO 14343-A	: G 19 9 Nb Si
EN ISO 14343-A	: G 19 9 Nb Si
AWS A5.9	: ER 347 Si

### Chemical Composition of Welding Wire % (Typical)

C	Si	Mn	Cr	Ni	Nb
0.035	0.9	1.2	19.4	9.7	+

### Mechanical Properties

Yield Strength (N/mm <sup>2</sup> )	Tensile Strength (N/mm <sup>2</sup> )	Impact Strength (ISO-V/+20°C)	Elongation ((L <sub>0</sub> =5d <sub>0</sub> ) (%))
min. 400	570- 710	min. 63 J	min. 30

### Typical Base Material Grades

- X6 CrNiNb 18 10, X6 CrNiTi 18 10, G-X5 CrNiNb 18 9, X5 CrNi 18 10, G-X 10 CrNi 18 8, X12 CrNiTi 18 9, X10 CrNiNb 18 10
- AISI & ASTM: 304, 321, 347, A157Gr.C9, A296Gr.CF8C, A320Gr.B8C, A320Gr.B8D

### Features and Applications

- Used for the welding of 13% Cr steels which are used in the textile, paper, paint and food industries
- Resistant to corrosion up to +400°C, suitable for MIG welding
- Ar+ %2.5 O<sub>2</sub> or Ar+ %2.5 CO<sub>2</sub> mixed gases are used for shielding, also used for the welding of materials which have the similar chemical composition to welding wire

### Welding Positions



### Current Type

MIG D.C.(+)

### Operating Data

Product Code	Diameter (mm) / (inch)		Weight (Kg)	Package Type
6011100359	1.0	0.040"	15	BS 300
6011100231	1.2	0.047"	15	BS 300

Approvals: GOST-R, CE, SEPRO

**Standards**

AWS A5.9 : ER 409 Nb

**Chemical Composition of  
Welding Wire % (Typical)**

C	Si	Mn	Cr	Ni	Mo
0.07	1.0	0.8	12.0	0.6	0.5

**Mechanical Properties**

Yield Strength (N/mm <sup>2</sup> )	Tensile Strength (N/mm <sup>2</sup> )	Elongation (L <sub>0</sub> =5d <sub>0</sub> ) (%)
min. 355	min. 450	min. 20

**Features and Applications**

- It used for the welding of ferritic stainless steel 409Gb and 409Ti which are commonly used for exhaust parts in automotive industry
- High resistant to thermal fatigue
- With help of Nb addition, Chromium carbide formation is prevented
- Ar+ %2.5 O<sub>2</sub> or Ar+ %2.5 CO<sub>2</sub> mixed gases are used as shielding gas

**Welding Positions**

**Current Type**

MIG D.C.(+)

**Operating Data**

Product Code	Diameter (mm) / (inch)		Weight (Kg)	Package Type
6011100364	1.20	0.047"	15	D 300

**Approvals:** GOST-R, CE, SEPRO

## Standards

TS EN ISO 14343-A	: G/W 13
EN ISO 14343-A	: G/W 13
AWS A5.9	: ER 410

## Chemical Composition of Welding Wire % (Typical)

C	Si	Mn	Cr
0.10	0.35	0.50	13.0

## Mechanical Properties (MIG)

Yield Strength (N/mm <sup>2</sup> )	Tensile Strength (N/mm <sup>2</sup> )	Elongation ((L <sub>0</sub> =5d <sub>0</sub> ) (%))	Heat Treatment
min. 250	min. 520	min. 20	840 °C - 870 °C/2h

## Typical Base Material Grades

- X 6 CrTi 17, X 20 CrNi 17 2, 431, 430 Ti
- AISI: 431, 430Ti

## Features and Applications

- Preferred use in formation of surfaces resistant to corrosion, wear, and heat.
- Maintained hardness at temperatures of up to 500°C
- Resistance to formation of oxide layers at temperatures up to 900°C
- Required use of Ar+ %2.5 O<sub>2</sub> or Ar+ %2.5 CO<sub>2</sub> mixed gas as shielding gas
- For TIG; Ar gas as shielding

## Welding Positions



## Current Type

MIG D.C. (+) / TIG D.C. (-)

## Operating Data

Product Code	Diameter x Length (mm) / (inch)		Weight (Kg)	Package Type
6011100365	1.0	0.040"	15	BS 300
6011100375	1.2	0.047"	15	BS 300
6011100196	2.40 x 1000	3/32 x 39"	5	Plastic Box

Approvals: GOST-R, CE, SEPRO

## Standards

TS EN ISO 14343-A	: G/W 17
EN ISO 14343-A	: G/W 17
AWS AS.9	: ER 430

## Chemical Composition of Welding Wire % (Typical)

C	Si	Mn	Cr
0.05	0.40	0.40	17.0

## Mechanical Properties (MIG)

Yield Strength (N/mm <sup>2</sup> )	Tensile Strength (N/mm <sup>2</sup> )	Elongation ((L <sub>0</sub> =5d <sub>0</sub> ) (%))	Heat Treatment
min. 300	min. 450	min. 20	760 - 790°C /2h

## Typical Base Material Grades

- X 6 CrTi 17, X 20 CrNi 17 2
- AISI: 431, 430Ti

## Features and Applications

- Applicability in surfacing to provide resistance to corrosion, wearing, and heat
- Requirement of use of for MIG : Ar+ %2.5 O<sub>2</sub> or Ar+ %2.5 CO<sub>2</sub> mix gas as shielding
- For TIG : Ar gas as shielding

## Welding Positions



## Current Type

MIG D.C.(+) / TIG D.C. (-)

## Operating Data

Product Code	Diameter x Length (mm) / (inch)		Weight (Kg)	Package Type
6011100403	1.0	0.040"	15	BS 300
6011100366	1.2	0.047"	15	BS 300
6011100376	1.6	0.062"	15	BS 300
6011100367	2.40 x 1000	3/32 x 39"	5	Plastic Box

Approvals: GOST-R, CE, SEPRO

**Standards**

TS EN ISO 14343-A	: W 22 9 3 N L
EN ISO 14343-A	: W 22 9 3 N L
AWS A5.9	: ER 2209

**Chemical Composition of  
Welding Wire % (Typical)**

C	Si	Mn	Cr	Ni	Mo	N
0.02	0.40	1.70	22.80	7.80	2.90	0.15

**Mechanical Properties**

Yield Strength (N/mm <sup>2</sup> )	Tensile Strength (N/mm <sup>2</sup> )	Elongation (L <sub>0</sub> =5d <sub>0</sub> ) (%)	Impact Strength (ISO-V/-46°C)
550	700	28	100 J

**Typical Base Material Grades**

- SAE 2209, SAE 2205, EN14462, X2CrNiMoN22-5-3, X2CrNiN23-4, X2CrNiMoN22-5-3 with X10CrNiMoNb18- 12 and X2CrNiMoN22-5-3 with P235GH/ P265GH, S255N, P295GH, S355N and 16Mo3 combinations, UNS S31803, S32205.

**Features and Applications**

- GeKa ELOX SG 2209 is duplex stainless steel TIG Welding rod contains low Carbon and approximate %22Cr, %9Ni and %3Mo
- Microstructure is Austenite + Ferritic
- The weld metal has an excellent resistance to stress corrosion, cracking and pitting
- The use of this welding rod, pipe and general manufacturing industries, offshore applications, oil, gas, chemical and petrochemical industry
- Shielding gas: TIG; pure Ar or Ar+%1-2N<sub>2</sub> mix gases can be used

**Welding Positions**

**Current Type**

MIG D.C. (+) / TIG D.C. (-)

**Operating Data**

Product Code	Diameter x Length (mm) / (inch)		Weight (Kg)	Package Type
6011100308	1,2	0.047"	15	BS 300
6011100309	2.00 x 1000	5/64 x 39"	5	Plastic Box
6011100310	2.40 x 1000	3/32 x 39"	5	Plastic Box

**Approvals:** GOST-R, CE, SEPRO

### Standards

TS EN ISO 14343-A	: W 25 9 4 N L
EN ISO 14343-A	: W 25 9 4 N L
AWS A5.9	: ER2594

### Chemical Composition of Welding Wire % (Typical)

C	Si	Mn	Cr	Ni	Mo
0.02	0.35	0.70	25.0	9.00	3.80

### Mechanical Properties

Yield Strength (N/mm <sup>2</sup> )	Tensile Strength (N/mm <sup>2</sup> )	Elongation ((L <sub>0</sub> =5d <sub>0</sub> ) (%))	Impact Strength (ISO-V/+20°C)
min. 550	min. 760	min. 18	min. 47 J

### Typical Base Material Grades

- (1.4501)X2CrNiMoCuWN25-7-4, (1.4515)GX3CrNiMoCuN26-6-3, (1.4517)GX3CrNiMoCuN25-6-3-3, UNS S 32750, S 32760 ZERON 100, SAF 25/07, FALC100

### Features and Applications

- GeKa ELOX SG 2594 is a super duplex welding wire.
- Used for the welding Austenitic-Ferritic stainless alloys of %25 Cr, %9 Ni, %3.5 Mo and low C types
- It has high resistance to intergranular corrosion and pitting
- GeKa ELOX SG 2594 is intended for welding super duplex alloys such as 2507, ASTM S32760, S32550 and A31260
- As the shielding gas, Argon (Ar) is used

### Welding Positions



### Current Type

TIG D.C. (-)

### Operating Data

Product Code	Diameter x Length (mm) / (inch)		Weight (Kg)	Package Type
6011100225	1.60 x 1000	1/16 x 39"	5	Plastic Box
6011100226	2.00 x 1000	5/64 x 39"	5	Plastic Box
6011100227	2.40 x 1000	3/32 x 39"	5	Plastic Box

Approvals: GOST-R, CE, SEPRO

**Standards**

TS EN ISO 18273	: S Al 4043 (AISI5)
EN ISO 18273	: S Al 4043 (AISI5)
AWS A5.10	: ER 4043

**Chemical Composition of Welding Wire % (Typical)**

Si	Mn	Al	Fe
5.0	0.03	rest	0.5

**Mechanical Properties**

Yield Strength (N/mm <sup>2</sup> )	Tensile Strength (N/mm <sup>2</sup> )	Elongation ((L <sub>0</sub> =5d <sub>0</sub> ) (%))	Working Temperature (°C)
110	150	15	575 - 633

**Typical Base Material Grades**

- AlMgSi 0.5, AlMg1SiCu, AlMgSi 1, AlZn4.5Mg 1, Al 99.5, Al 99, AlCuMg 1, AlMgSi 0.7, AlMgSi 0.8, AlMgSiCu, AlMn 1, G-AISI 6 Cu 4

**Features and Applications**

- It is Al-Si welding MIG wire
- Application range is joining of cast aluminum parts and aluminum profiles, motor blocks.
- Material range is AlMgSi 0.5, AlMgSiCu, Al99.5 etc
- It is recommended that preheating to 105°C before welding of plates thicker than 10 mm
- Required use of Ar, He or Ar+He gas as shielding gas

**Welding Positions**

**Current Type**

MIG D.C. (+)

**Operating Data**

Product Code	Diameter (mm) / (inch)		Package Weight (Kg)
6011100292	0.8	0.030"	5
6011100293	1.0	0.040"	7
6011100294	1.2	0.047"	7
6011100295	1.6	0.062"	7

**Standards**

TS EN ISO 18273	: ~S Al 1100 (Al 99.0 Cu)
EN ISO 18273	: ~S Al 1100 (Al 99.0 Cu)
AWS A5.10	: ~ER1100

**Chemical Composition of Welding Wire % (Typical)**

Al	Cu	Fe	Si
99.5	0.10	<0.40	<0.30

**Mechanical Properties**

Yield Strength (N/mm <sup>2</sup> )	Tensile Strength (N/mm <sup>2</sup> )	Elongation ((L <sub>0</sub> =5d <sub>0</sub> ) (%))	Working Temperature (°C)
50	85	25	647 - 658

**Typical Base Material Grades**

- Al 99.5, Al 99.7, Al 99.8, E Al 99.9, Al 99, E-Al MgSi

**Features and Applications**

- It is aluminum MIG welding wire
- Application field is truck chassis and body, tanks, buses and containers, railway trucks, marine applications, pipes, flanges, panels, ship ports, barriers, ship boards etc
- It is recommended that preheating to 150°C before welding of plates thicker than 10mm

**Welding Positions**

**Current Type**

MIG D.C.(+)

**Operating Data**

Product Code	Diameter (mm) / (inch)		Package Weight (Kg)
6011100268	0.80	0.030"	5
6011100032	1.00	0.040"	7
6011100033	1.20	0.047"	7
6011100269	1.60	0.062"	7



### Standards

TS EN ISO 18273	: S Al 5754 (AlMg3)
EN ISO 18273	: S Al 5754 (AlMg3)
AWS A5.10	: ER 5754

### Chemical Composition of Welding Wire % (Typical)

Mg	Mn	Si	Fe	Al
3.0	<0.5	<0.40	<0.40	rest

### Mechanical Properties

Yield Strength (N/mm <sup>2</sup> )	Tensile Strength (N/mm <sup>2</sup> )	Elongation ((L <sub>0</sub> =5d <sub>0</sub> ) (%))	Working Temperature (°C)
100	200	20	610 - 642

### Typical Base Material Grades

- AlMg 1, AlMg 2.5, AlMg 3, AlMg 2.7 Mn, AlMg Si 0.5, AlMg 2, AlMg2 Mn 0.8, AlMgSi 0.7, AlMgSi 0.8, G-AlMg 3, G-AlMg3 (Cu), G-AlMg 3 Si.

### Features and Applications

- It is used for joining aluminum alloys includes up to 3 % Mg. Resistance to sea water. Parent metals AlMg 1, AlMg 2.5, and AlMg 2 Mn 0.8 etc
- Required use of Ar, He or Ar+He gas as shielding gas
- It is recommended that preheating to 150°C before welding of plates thicker than 10mm

### Welding Positions



### Current Type

MIG D.C. (+)

### Operating Data

Product Code	Diameter (mm) / (inch)		Package Weight (Kg)
6011100271	1.20	0.047"	7
6011100272	1.60	0.062"	7

**Standards**

TS EN ISO 18273	: S Al 5356 (AlMg5Cr(A))
EN ISO 18273	: S Al 5356 (AlMg5Cr(A))
AWS A5.10	: ER 5356

**Chemical Composition of  
Welding Wire % (Typical)**

Mg	Mn	Si	Fe	Al
5.0	0.3	<0.25	<0.40	rest

**Mechanical Properties**

Yield Strength (N/mm <sup>2</sup> )	Tensile Strength (N/mm <sup>2</sup> )	Elongation (L <sub>0</sub> =5d <sub>0</sub> ) (%)	Working Temperature (°C)
180	260	20	575 - 633

**Typical Base Material Grades**

- AlMg 5, AlMg 4.5, G-AlMg 5, G-AlMg 10, AlMgSi 1, G-AlMg 3(Cu), AlMg 2.5Mn, AlMg 2 Mn 0.8, AlMg 3, AlMg 3 Si, G-Almg 3, AlMg 4.5 Mn, G-AlMg 3 Si, AlMg Si 0.5, AlMgSi 0.7, AlMgSi 0.8, AlMgSi 0.8, AlMgSi 1 Cu, AlZn 4.5 Mg 1.

**Features and Applications**

- It is used for joining aluminum alloys includes over 3 % Mg. Resistance to sea water
- Application field is cup and boilers, columns, marine applications
- Required use of Ar, He or Ar+He gas as shielding gas
- It is recommended that preheating to 150°C before welding of plates thicker than 10mm

**Welding Positions**

**Current Type**

MIG D.C.(+)

**Operating Data**

Product Code	Diameter (mm) / (inch)		Package Weight (Kg)
6011100277	0.80	0.030"	5
6011100278	1.00	0.040"	7
6011100279	1.20	0.047"	7
6011100058	1.60	0.062"	7

### Standards

TS EN ISO 18273	: S Al 5183(AlMg4.5Mn0.7A)
EN ISO 18273	: S Al 5183(AlMg4.5Mn0.7A)
AWS A5.10	: ER 5183

### Chemical Composition of Welding Wire % (Typical)

Mg	Mn	Si	Fe	Al	Cr
5.0	0.8	<0.40	<0.40	rest	0.20

### Mechanical Properties

Yield Strength (N/mm <sup>2</sup> )	Tensile Strength (N/mm <sup>2</sup> )	Elongation ((L <sub>0</sub> =5d <sub>0</sub> ) (%))	Working Temperature (°C)
170	250	20	574 - 638

### Typical Base Material Grades

- AlMg 2.7 Mn, AlMg 3, AlMg 4.5 Mn, AlMg 4 Mn, AlMg 5, AlMgSi 0.5, AlMgSi, 0.7, AlMgSi 0.8, AlMgSi 1, AlMgSi 1 Cu, AlZn 4.5 Mg 1, AlZMgCu 1.5, AlZnMgCu 0.5, G-AlMg 5 Si, G-AlMg 3, G-AlMg 5.

### Features and Applications

- It is used in welding exposed to sea water aluminum parts, high strength aluminum alloys work in low temperatures (-196°C)

### Welding Positions



### Current Type

MIG D.C. (+)

### Operating Data

Product Code	Diameter (mm) / (inch)		Package Weight (Kg)
6011100275	1.00	0.040"	7
6011100276	1.20	0.047"	7

**Standards**

TS EN ISO 18273	: S Al 4043 (AlSi5)
EN ISO 18273	: S Al 4043 (AlSi5)
TS EN ISO 17672	: Al 105
EN ISO 17672	: Al 105
AWS A5.10	: ER 4043

**Chemical Composition of  
Welding Wire % (Typical)**

Al	Si	Mn	Fe
rest	5.0	0.03	0.5

**Mechanical Properties**

Density (kg/dm <sup>3</sup> )	Yield Strength (N/mm <sup>2</sup> )	Tensile Strength (N/mm <sup>2</sup> )	Elongation ((L <sub>0</sub> =5d <sub>0</sub> ) (%))	Melting Range (N/mm <sup>2</sup> )
2.7	100	160	15	573-625

**Features and Applications**

- AlSi5 is aluminum TIG rod with high content of silicon
- It is used for joining and filling of aluminum silicon cast alloys including up to 7% silicon
- It is recommended that preheating to 150°C before welding of plates thicker than 15 mm
- For gas welding, GeKaTec F-LH1 is recommended

**Welding Method**

TIG Welding - Gas Welding

Current Type	MIG Wire	Electrode
TIG A.C.	GeKa AlSi5	GeKaTec Aluweld Si

**Welding Positions**

**Operating Data**

Product Code	Diameter x Length		Package Weight (Kg)
	(mm) / (inch)		
6011100296	1.6 x 1000	1/16 x 39"	5
6011100249	2.0 x 1000	5/64 x 39"	5
6011100250	2.4 x 1000	3/32 x 39"	5
6011100251	3.2 x 1000	1/8 x 39"	5
6011100297	4.0 x 1000	5/32 x 39"	5

**Approvals:** GOST-R, SEPRO

**Standards**

TS EN ISO 18273	: S Al 4047 (AISI 12)
EN ISO 18273	: S Al 4047 (AISI 12)
TS EN ISO 17672	: Al 112
EN ISO 17672	: Al 112
AWS A5.10	: ER 4047

**Chemical Composition of  
Welding Wire % (Typical)**

Al	Si	Fe	Mn
rest	12.0	<0.5	<0.3

**Mechanical Properties**

Density (kg/dm <sup>3</sup> )	Yield Strength (N/mm <sup>2</sup> )	Tensile Strength (N/mm <sup>2</sup> )	Elongation (L <sub>0</sub> =5d <sub>0</sub> ) (%)	Melting Range (°C)	Hardness (HB)
2.6	80	170	8	575 - 585	45

**Features and Applications**

- AISI 12 is aluminum TIG rod with high content of Silicon
- It is used for joining and filling of aluminum silicon cast alloys including more than 7% silicon
- It has a good fluidity. Oxyacetylene welding and brazing is possible with GeKaTec F-LH1
- It is recommended that preheating to 150°C before welding of plates thicker than 15mm
- Shielding gas: Ar

**Welding Method**

TIG Welding - Gas Welding

Current Type	Electrode
TIG A.C.	GeKaTec Aluweld 12 Si

**Welding Positions**

**Operating Data**

Product Code	Diameter x Length (mm) / (inch)		Package Weight (Kg)
6011100288	2,00 x 1000	5/64 x 39"	5
6011100289	2,40 x 1000	3/32 x 39"	5
6011100290	3,20 x 1000	1/8 x 39"	5

**Approvals:** GOST-R, SEPRO

## Standards

TS EN ISO 18273	: ~S Al 1100 (Al 99.0 Cu)
EN ISO 18273	: ~S Al 1100 (Al 99.0 Cu)
AWS A5.10	: ~ER1100

## Chemical Composition of Welding Wire % (Typical)

Al
min. 99

## Mechanical Properties

Density (kg/dm <sup>3</sup> )	Yield Strength (N/mm <sup>2</sup> )	Tensile Strength (N/mm <sup>2</sup> )	Elongation ((L <sub>0</sub> =5d <sub>0</sub> ) (%))	Melting Range (°C)	Electrical Conductivity (Sm/mm <sup>2</sup> )
2.7	min. 40	min. 70	30	658 - 674	35

## Features and Applications

- Al99.5 TIG is pure aluminum welding TIG rod
- It is used for joining of aluminum alloys required high electrical conductivity
- It is recommended that preheating to 200°C before welding of plates thicker than 15mm
- For gas welding, GeKaTec F-LH1 is recommended
- Shielding gas: Ar

## Welding Method

TIG Welding - Gas Welding

Current Type	MIG Wire	Electrode
TIG A.C.	GeKa Al99.5	GeKaTec Aluweld 99Al

## Welding Positions



## Operating Data

Product Code	Diameter x Length (mm) / (inch)		Package Weight (Kg)
6011100036	2.0 x 1000	5/64 x 39"	5
6011100392	2.4 x 1000	3/32 x 39"	5
6011100038	3.2 x 1000	1/8 x 39"	5
6011100039	4.0 x 1000	5/32 X 39"	5

Approvals: GOST-R, SEPRO

**Standards**

TS EN ISO 18273	: S Al 5356 (AlMg5Cr(A))
EN ISO 18273	: S Al 5356 (AlMg5Cr(A))
DIN 1732	: SG-AlMg5
AWS A5.10	: ER 5356

**Chemical Composition of  
Welding Wire % (Typical)**

Al	Mg	Si	Mn
rest	5.0	0.5	0.5

**Mechanical Properties**

Densitt (kg/dm <sup>3</sup> )	Yield Strength (N/mm <sup>2</sup> )	Tensile Strength (N/mm <sup>2</sup> )	Elongation (L <sub>0</sub> =5d <sub>0</sub> ) (%)	Melting Range (°C)	Hardness (HB)
2.6	120	250	25	560 - 630	70

**Features and Applications**

- AlMg5 is magnesium alloyed aluminum TIG rod
- It is used for joining of aluminum alloys required high mechanical properties
- The weld deposit has a good resistance to atmospheric influences and sea water
- And the weld metal is proper for surface treatment such as anodizing and polishing
- it is recommended that preheating to 150°C before welding of plates thicker than 15mm
- For gas welding, GeKaTec F-LH1 is recommended
- Shielding gas: Ar

**Welding Method**

TIG Welding - Gas Welding

Current Type	MIG Wire
TIG A.C.	GeKa AlMg 5

**Welding Positions**

**Operating Data**

Product Code	Diameter x Length (mm) / (inch)		Package Weight (Kg)
6011100062	1,60 x 1000	1/16 x 39"	5
6011100281	2,00 x 1000	5/64 x 39"	5
6011100282	2,40 x 1000	3/32 x 39"	5

**Approvals:** GOST-R, SEPRO

**Standards**

TS EN ISO 18273	: SAI 5183(AlMg4.5Mn0.7A)
EN ISO18273	: SAI 5183(AlMg4.5Mn0.7A)
AWS A5.10	: ER 5183

**Chemical Composition of  
Welding Wire % (Typical)**

Al	Si	Fe	Mn	Mg	Cr
rest	<0.4	<0.4	0.8	5.0	0.2

**Mechanical Properties**

Densitt (kg/dm <sup>3</sup> )	Yield Strength (N/mm <sup>2</sup> )	Tensile Strength (N/mm <sup>2</sup> )	Elongation (L <sub>0</sub> =5d <sub>0</sub> ) (%)	Melting Range (°C)	Hardness (HB)
2.6	170	250	20	575 - 585	45

**Features and Applications**

- AlMg4.5Mn is Magnesium alloyed Aluminum TIG rod
- It is used for joining of Aluminum alloys including more than 3% Mg
- The weld deposit has a good resistance to atmospheric influences and sea water
- It is recommended that preheating to 150 °C before welding of plates thicker than 15mm
- For gas welding, GeKaTec F-LH1 is recommended
- Shielding gas: Ar

**Welding Method**

TIG Welding - Gas Welding

**Welding Positions**

**Current Type**

TIG A.C.

**Operating Data**

Product Code	Diameter x Length (mm) / (inch)		Package Weight (Kg)
6011100284	2.0 x 1000	5/64 x 39"	5
6011100393	2.4 x 1000	3/32 x 39"	5
6011100285	3.2 x 1000	1/8 x 39"	5

**Approvals:** GOST-R, SEPRO



**Standards**

TS EN ISO 24373	: S Cu 6560 (CuSi3Mn1)
EN ISO 24373	: S Cu 6560 (CuSi3Mn1)
AWS A5.7	: ER CuSiA

**Chemical Composition of Welding Wire % (Typical)**

Si	Mn	Fe	Sn	Cu
3.0	1.0	<0.20	0.10	rest

**Mechanical Properties**

Yield Strength (N/mm <sup>2</sup> )	Tensile Strength (N/mm <sup>2</sup> )	Elongation (L <sub>0</sub> =5d <sub>0</sub> ) (%)	Hardness (HB)
130	220	30	55

**Typical Base Material Grades**

- CuSi 2 Mn, CuSi 3 Mn, CuMn 5, CuMn 2, Galvanized steels and Cu-Zn (brass) alloyed, Cu-Mn alloyed

**Features and Applications**

- It is Copper-Silicon alloyed MIG welding wire and used in welding of galvanized steels
- Shielding Gas: Ar

**Welding Positions**

**Current Type**

MIG D.C. (+)

**Operating Data**

Product Code	Diameter (mm) / (inch)		Weight (Kg)
6031100261	0.8	0.030"	15
6031100262	1.0	0.040"	15
6031100263	1.2	0.047"	15

**Standards**

TS EN ISO 24373	: ~S Cu1898 (CuSn1)
EN ISO 24373	: ~S Cu1898 (CuSn1)
AWS A5.7	: ER Cu

**Chemical Composition of Welding Wire % (Typical)**

Si	Mn	Sn	Cu
0.3	0.3	0.8	rest

**Mechanical Properties**

Yield Strength (N/mm <sup>2</sup> )	Tensile Strength (N/mm <sup>2</sup> )	Elongation (L <sub>0</sub> =5d <sub>0</sub> ) (%)	Hardness (HB)
115	200	35	60

**Typical Base Material Grades**

- OF-Cu, SE-Cu, SW-Cu, SF-Cu, Cu Fe 2P, CuSP, CuTeP, E-Cu C, F-Cu, D-Cu, SD Cu, SB-Cu, SA-Cu.

**Features and Applications**

- It is Cu-Sn alloy welding wire
- It is used in welding of pure copper and copper based low alloy, tank and boilers, graphite electrode holders, slag baths, oxygen tubes, electrical equipment
- Shielding Gas: Ar, He, Ar+He

**Welding Positions**

**Current Type**

MIG D.C. (+)

**Operating Data**

Product Code	Diameter (mm) / (inch)		Weight (Kg)
6031100266	1.0	0.040"	15
6031100386	1.2	0.047"	15
6031100267	1.6	0.062"	15

Approvals: GOST-R, SEPRO

**Standards**

TS EN ISO 24373	: S Cu1897 (CuAg1)
EN ISO 24373	: S Cu1897 (CuAg1)

**Chemical Composition of  
Welding Wire % (Typical)**

Ag	P	Mn	Cu
0.8-1.2	0.01	0.1	rest

**Mechanical Properties**

Yield Strength (N/mm <sup>2</sup> )	Tensile Strength (N/mm <sup>2</sup> )	Elongation (L <sub>0</sub> =5d <sub>0</sub> ) (%)	Hardness (HB)
80	200	20	~ 50

**Typical Base Material Grades**

- 2.0076, 2.0090, 2.0040

**Features and Applications**

- Applicability in arc welding of copper materials with high electric conductivity, of copper- silver alloys containing low amounts of phosphor as well as of pure copper
- Additional applicability in gas welding of deoxidized copper
- High electric conductivity (30-45 S.m/mm<sup>2</sup>)
- Use of Ar (I1) as shielding gas

**Welding Positions**

**Current Type**

MIG D.C. (+)

**Operating Data**

Product Code	Diameter (mm) / (inch)		Weight (Kg)
6031100264	1.2	0.047"	15

**Standards**

TS EN ISO 24373	: Cu5410 (CuSn12 P)
EN ISO24373	: Cu5410 (CuS212P)

**Chemical Composition of Welding Wire % (Typical)**

Sn	P	Fe	Cu
12.0	0.20	<0.10	rest

**Mechanical Properties**

Yield Strength (N/mm <sup>2</sup> )	Tensile Strength (N/mm <sup>2</sup> )	Elongation (L <sub>0</sub> =5d <sub>0</sub> ) (%)	Hardness (HB)
260	380	10	130

**Typical Base Material Grades**

- Cu Sn 8, Cu Sn 12

**Features and Applications**

- It is Cu-Sn alloy welding wire
- It is used in welding of pure copper and copper based low alloy, tank and boilers, graphite electrode holders, slag baths, oxygen tubes, electrical equipment
- Shielding Gas: Ar, Ar+He

**Welding Positions**

**Current Type**

MIG D.C. (+)

**Operating Data**

Product Code	Diameter (mm) / (inch)		Weight (Kg)
6011100407	1.0	0.040"	15
6011100408	1.2	0.047"	15
6011100409	1.6	0.062"	15

**Approvals:** GOST-R, SEPRO

**Standards**

TS EN ISO 24373	: CuSn6 P - CF452K
EN ISO 24373	: CuSn6 P - CF452K
AWS A 5.7	: ~ER CuSn -A

**Chemical Composition of Welding Wire % (Typical)**

Sn	P	Fe	Cu	Pb
6.0	0.20	<0.10	rest	<0.02

**Mechanical Properties**

Yield Strength (N/mm <sup>2</sup> )	Tensile Strength (N/mm <sup>2</sup> )	Elongation (L <sub>0</sub> =5d <sub>0</sub> ) (%)	Hardness (HB)
270	410	30	100

**Typical Base Material Grades**

- CuSn 2, CuSn 4, CuSn 6, CuSn 8, CuSn 6 Zn, G-CuSn 2 ZnPb, G-CuSn 5 ZnPb, G-CuSn 6 ZnNi.

**Features and Applications**

- It is Cu-Sn alloy welding wire
- Joining and surfacing of tin bronzes, cast tin bronzes, such as CuSn 2, CuSn 6, CuSn 8 and CuSn 6 Zn
- Shielding Gas: Ar, Ar+He

**Welding Positions**

**Current Type**

MIG D.C. (+)

**Operating Data**

Product Code	Diameter (mm) / (inch)		Weight (Kg)
6031100272	1.0	0.040"	15
6031100273	1.2	0.047"	15
6031100052	1.6	0.062"	15

**Approvals:** GOST-R, SEPRO

**Standards**

TS EN ISO 24373	: Cu6180 (CuAl10Fe)
EN ISO 24373	: Cu6180 (CuAl10Fe)
AWS A 5.7	: ER CuAl-A2

**Chemical Composition of Welding Wire % (Typical)**

Al	Si	Fe	Cu
9.0	<0.10	<1.50	rest

**Mechanical Properties**

Yield Strength (N/mm <sup>2</sup> )	Tensile Strength (N/mm <sup>2</sup> )	Elongation (L <sub>0</sub> =5d <sub>0</sub> ) (%)	Hardness (HB)
410	590	45	145

**Typical Base Material Grades**

- CuAl 5, CuAl 8, G-CuAl 8 Mn

**Features and Applications**

- It is Cu- Al MIG welding wire
- It is used for welding of sea water vaporizers, door accessories, rolling equipment, CuAl 5, CuAl 8, G-CuAl 8 Mn

**Welding Positions**

**Current Type**

MIG D.C. (+)

**Operating Data**

Product Code	Diameter (mm) / (inch)		Weight (Kg)
6031100042	1.0	0.040"	15
6031100043	1.2	0.047"	15
6031100044	1.6	0.062"	15

Approvals: GOST-R, SEPRO

**Standards**

TS EN ISO 24373	: S Cu 6100 (CuAl8)
EN ISO 24373	: S Cu 6100 (CuAl8)
AWS A5.7	: CuAl-A1

**Chemical Composition of Welding Wire % (Typical)**

Al	Si	Zn	Cu	Mn
8.0	<0.10	<0.20	rest	<0.50

**Mechanical Properties**

Yield Strength (N/mm <sup>2</sup> )	Tensile Strength (N/mm <sup>2</sup> )	Elongation (L <sub>0</sub> =5d <sub>0</sub> ) (%)	Hardness (HB)
200	430	40	100

**Typical Base Material Grades**

- CuAl 5, CuAl 8, G-CuAl 8 Mn, CuAl 5 As, CuZn 20 Al 2

**Features and Applications**

- It is Cu-Al MIG welding wire
- It is used for surfacing of steel and cast steels
- It is used for joining and surfacing of Aluminum Bronzes, e.g. (CuAl5), (CuAl8), G-CuAl 8 Mn, Cu Al 5 As, C Zn 20 Al 2, surfacing of Copper, Brass, non alloyed and low alloyed steels
- Shielding Gas: Ar, He+Ar, He
- Metal to metal wear, sea water and is used in parts exposed to corrosive liquids such as acids

**Welding Positions**

**Current Type**

MIG D.C. (+)

**Operating Data**

Product Code	Diameter (mm) / (inch)		Package Weight (Kg)
6031100268	1.0	0.040"	15
6031100270	1.2	0.047"	15
6031100271	1.6	0.062"	15
6031100269	1.0	0.040"	200 (Big Pack)

**Standards**

AWS A5.7 : ER CuMnNiAl

**Chemical Composition of  
Welding Wire % (Typical)**

Al	Fe	Ni	Cu	Mn
7.5	2.5	2.0	rest	13.0

**Mechanical Properties**

Yield Strength (N/mm <sup>2</sup> )	Tensile Strength (N/mm <sup>2</sup> )	Elongation (L <sub>0</sub> =5d <sub>0</sub> ) (%)	Hardness (HB)
470	650	20	205

**Typical Base Material Grades**

- Ductile cast iron steels, ductile cast Iron-Manganese steels.

**Features and Applications**

- Mn-Ni, Aluminum bronze MIG welding wire
- Used for welding of screw, clutch pulley and compression plates
- Shielding gas: Ar

**Welding Positions**

**Current Type**

MIG D.C. (+)

**Operating Data**

Product Code	Diameter (mm) / (inch)		Weight (Kg)
6031100274	1.2	0.047"	15



**Standards**

TS EN ISO 24373	: S Cu 7158 (CuNi30)
EN ISO 24373	: S Cu 7158 (CuNi30)
AWS A5.7	: ER CuNi

**Chemical Composition of  
Welding Wire % (Typical)**

Mn	Ti	Fe	Ni	S	Cu
0.9	0.4	0.5	30.0	<0.01	rest

**Mechanical Properties**

Yield Strength (N/mm <sup>2</sup> )	Tensile Strength (N/mm <sup>2</sup> )	Impact Strength (ISO-V/+20°C)	Elongation ((L <sub>0</sub> =5d <sub>0</sub> ) (%))
250	400	100 J	30

**Typical Base Material Grades**

- CuNi 10 Fe 1 Mn (2.0872) - CuNi 20 Fe (2.0878) - CuNi 30 Fe (2.0882)

**Features and Applications**

- It is used of Copper alloys includes up to 30% Nickel, joining and surfacing of steel alloys.
- Joining of stainless steel to copper alloys is possible
- Because of excellent resistance to sea water corrosion, it is used marine off-shore applications, sea water exchangers and food & chemical industries
- Shielding Gas: Ar

**Welding Positions**

**Current Type**

TIG D.C.(-)

**Operating Data**

Product Code	Diameter x Length (mm) / (inch)		Weight (Kg)
6031100255	1.6 x 1000	1/16 x 39"	5
6031100256	2.0 x 1000	5/64 x 39"	5
6031100257	2.4 x 1000	3/32 x 39"	5

**Approvals:** GOST-R, SEPRO

**Standards**

TS EN ISO 24373	: S Cu 7061(CuNi10)
EN ISO 24373	: S Cu 7061(CuNi10)
DIN 1733	: SG CuNi10 Fe

**Chemical Composition of  
Welding Wire % (Typical)**

Cu	Fe	Mn	Ti	Ni
rest	1.8	1.0	0.17	10.0

**Mechanical Properties**

Yield Strength (N/mm <sup>2</sup> )	Tensile Strength (N/mm <sup>2</sup> )	Elongation (L <sub>0</sub> =5d <sub>0</sub> ) (%)	Hardness (HB)
150	350	30	200

**Typical Base Material Grades**

- CUNIFER 30, CUNIFER 40, Cu90-Ni10 and low Ni Alloys Cu-Ni alloys
- 2.0862 CuNi5Fe, 2.0872 CuNi10Fe

**Features and Applications**

- It is used for copper nickel alloys with 10% nickel such as CuNi5Fe, CuNi10Fe.
- Weld deposit is highly corrosion resistant
- It is used for joining and surfacing copper-nickel alloys and CuNiFe pipes which perform in corrosive areas such as seawater
- Shielding Gas: Ar

**Welding Positions**

**Current Type**

TIG D.C.(-)

**Operating Data**

Product Code	Diameter x Length (mm) / (inch)		Weight (Kg)
6031100258	1,60 x 1000	1/16 x 39"	5
6031100259	2,00 x 1000	5/64 x 39"	5
6031100385	2,40 x 1000	3/32 x 39"	5
6031100260	3,20 x 1000	1/8 x 39"	5

**Approvals:** GOST-R, SEPRO

**Standards**

TS EN ISO 17632-A	: T 42 4 P C 1 H5
EN ISO 17632-A	: T 42 4 P C 1 H5
AWS A5.20	: E 71T-1C-J

**Chemical Composition of  
Weld Metal (Typical)**

C	Si	Mn
0.06	0.5	1.3

**Mechanical Properties**

Heat Treatment	Yield Strength (N/mm <sup>2</sup> )	Tensile Strength (N/mm <sup>2</sup> )	Impact Strength (ISO-V/-40°C)	Elongation ((L <sub>0</sub> =5d <sub>0</sub> ) (%))
AW	min. 420	500- 640	min. 50 J	min. 22

AW: as welded

**Typical Base Material Grades**

- S235JR, S275JR, S235J2G3-S355J2G3, P 235T1-P355T1, P235T2-P355T2, L210NB-L360NB, L290MB L360MB , P235G1TH, P255G1TH, P235GH-P355GH , P295GH, S235JRS1-S235J4S, S315G1S-S355G3S, S255N-S380N, S255NL-S355NL, GE200-GE260

**Features and Applications**

- Rutile type flux-cored wire which is used for the production welding of machine and welding applications on ship, industry vehicle building and steel constructions in all positions
- Provides high mechanical properties, proper, smooth, X-ray safety seams
- It is economical as it has high melting ability and can work under high current in all positions
- Shielding gas : %100 CO<sub>2</sub>

**Welding Positions**

**Current Type**

FCAW / D.C. (+)

**Operating Data**

Product Code	Diameter (mm) / (inch)		Weight (Kg)	Package Type
	mm	inch		
3010500008	1.20	0.047"	4.5	D 200
3010500018	1.20	0.047"	15	D 300
3010500023	1.20	0.047"	15	BS 300
3010500020	1.60	0.062"	15	BS 300
3010500035	1.60	0.047"	200	BIG PACK

**Approvals:** ELCOR R71 (CO2) : TL, DNV-GL , BV, ABS, LR, RS, DB NK , RINA , CE, GOST-R, HAKK (1.20mm), SEPRO

### Standards

TS EN ISO 17632-A	: T 46 2 P M 1
EN ISO 17632-A	: T 46 2 P M 1
AWS A5.20	: E71 T-1M

### Chemical Composition of Weld Metal (Typical)

C	Si	Mn
0.06	0.5	1.3

### Mechanical Properties

Heat Treatment	Yield Strength (N/mm <sup>2</sup> )	Tensile Strength (N/mm <sup>2</sup> )	Impact Strength (ISO-V/-20°C)	Elongation ((L <sub>0</sub> =5d <sub>0</sub> ) (%))
AW	min. 460	530- 600	min. 50 J	min. 22

AW: as welded

### Typical Base Material Grades

- S235JR, S275JR, S235J2G3- S355J2G3, P 235T1-P355T1, P235T2-P355T2, L210NB-L360NB, L290MB-L360MB, P235G1TH, P255G1TH, P235GH-P355GH, P295GH, S235JRS1-S235J4S, S315G1S-S355G3S, S255N-S380N, S255NL-S355NL, GE200-GE260

### Features and Applications

- Rutile type flux cored wire which is used for the production welding of machine and welding applications on ship, and steel constructions in all positions. Provides high mechanical properties, proper, smooth, X-ray safety seams
- It is economical as it has high melting ability and can work with high current in all positions. Shielding Gas: M21 (CO<sub>2</sub>)

### Welding Positions



### Current Type

FCAW / D.C. (+)

### Operating Data

Product Code	Diameter (mm) / (inch)		Weight (Kg)	Package Type
3010500112	1.20	0.047"	15	BS 300

Approvals: CE, GOST-R, SEPRO

### Standards

TS EN ISO 17632-A	: T 46 4 P C1 H5 / T46 3 P M1 H5
EN ISO 17632-A	: T 46 4 P C1 H5 / T46 3 P M1 H5
AWS A5.20	: E71 T-1C/-1M H4

### Chemical Composition of Weld Metal (Typical)

C	Si	Mn
0.05	0.5	1.3

### Mechanical Properties

Heat Treatment	Yield Strength (N/mm <sup>2</sup> )	Tensile Strength (N/mm <sup>2</sup> )	Impact Strength		Elongation ((L <sub>0</sub> =5d <sub>0</sub> ) (%))
			(ISO-V/-30°C) (with M21 gas)	(ISO-V/-40°C) (with CO <sub>2</sub> gas)	
AW	min. 460	530-680	min. 47 J	min. 47 J	min. 22

AW: as welded

### Typical Base Material Grades

- S235JR, S275JR, S235J2G3-S355J2G3, P 235T1-P355T1, P235T2-P355T2, L210NB-L360NB, L290MB L415MB, P235G1TH, P255G1TH, P235GH-P355GH, P295GH, S235JRS1-S235J4S, S315G1S-S355G3S, S255N-S380N, S255NL-S355NL, GE200-GE260

### Features and Applications

- Rutile type flux cored wire which is used for the production welding of machine and welding applications on ship, and steel constructions in all positions. Provides high mechanical properties, proper, smooth, X-ray safety seams. It is economical as it has high melting ability and can work with high current in all positions. Shielding Gas: CO<sub>2</sub> or M21

### Welding Positions



### Current Type

FCAW / D.C. (+)

### Operating Data

Product Code	Diameter (mm) / (inch)		Weight (Kg)	Package Type
6011100024	1.20	0.047"	15	D 300

Approvals: CE, GOST-R, SEPRO

**Standards**

TS EN ISO 17632-A	: T 42 4 R C3 H10
EN ISO 17632-A	: T 42 4 R C3 H10
AWS A5.20	: E 70 T-9 C J H 8

**Chemical Composition of  
Weld Metal (Typical)**

C	Si	Mn
0.04	0.70	1.40

**Mechanical Properties**

Yield Strength (N/mm <sup>2</sup> )	Tensile Strength (N/mm <sup>2</sup> )	Impact Strength (ISO-V/-40°C)	Elongation ((L <sub>0</sub> =5d <sub>0</sub> ) (%))
min. 420	500- 640	min. 47 J	min. 22

**Features and Applications**

- Metal-Rutile type flux cored welding wire
- High fill rate and deep penetration
- Suitability flat and horizontal fillet weld
- Excellent notch toughness value at low temperatures.
- Shielding Gas: CO<sub>2</sub>

**Welding Positions**

**Current Type**

FCAW / D.C. (+)

**Operating Data**

Product Code	Diameter (mm) / (inch)		Weight (Kg)	Package Type
3010500122	1.20	0.047"	15	BS 300

**Approvals:** CE, GOST-R, SEPRO

**Standards**

TS EN ISO 17632-A	: T 42 4 B M 3 H5
EN ISO 17632-A	: T 42 4 B M 3 H5
AWS A5.20	: E70T-5M J

**Chemical Composition of  
Weld Metal (Typical)**

C	Si	Mn
0.05	0.55	1.35

**Mechanical Properties**

Heat Treatment	Yield Strength (N/mm <sup>2</sup> )	Tensile Strength (N/mm <sup>2</sup> )	Impact Strength		Elongation (L <sub>0</sub> =5d <sub>0</sub> ) (%)
			(ISO-V/-30°C)	(ISO-V/-40°C)	
AW or A	min. 420	520 - 670	120 J	min. 47 J	min. 22

AW: as welded    A: aging

**Typical Base Material Grades**

- EN: S185, S235-S355, P 235 GH, P 265 GH, P 295 GH, P 235 T1/T2-P355N, I2 10-L485, S 255-S460, X42-X70  
 ASTM: A 131 , A106/A515/A 714, A283/A285/A414/A662/A372, A369/A210/A106, A516/A255/A 333/ A350/

**Features and Applications**

- Used for semi-automatic or fully automatic welding of alloyed or unalloyed construction steels, thin-walled steels
- it has soft arc, deep penetration, good bead features
- Impact strength values are higher than those of E71 T-1 in at low temperatures
- M21 gas is used for shielding

**Welding Positions**

**Current Type**

FCAW / D.C. (+)

**Operating Data**

Product Code	Diameter (mm) / (inch)		Weight (Kg)	Package Type
3010500141	1.20	0.047"	15	BS 300
3010500143	1.60	0.062"	15	BS 300

**Approvals:** CE, GOST-R, DB , SEPR0

**Standards**

TS EN ISO 17632-A	: T 42 4 B C M 3 H5
EN iso 17632-A	: T 42 4 B C M 3 H5
AWS A5.20	: E 70T-5C/-5M H4

**Chemical Composition of  
Weld Metal (Typical)**

C	Si	Mn
0.05	0.60	1.40

**Mechanical Properties**

Heat Treatment	Yield Strength (N/mm <sup>2</sup> )	Tensile Strength (N/mm <sup>2</sup> )	Impact Strength		Elongation ((L <sub>0</sub> =5d <sub>0</sub> ) (%))
			(ISO-V/-20°C)	(ISO-V/-40°C)	
AW or SR	min. 470	550 - 640	min. 100 J	min. 60 J	min. 27

AW: as welded SR: stress relieved

**Typical Base Material Grades**

- EN: S185, S235-S355, P 235 GH, P 265 GH, P 295 GH, P 235 T1/T2-P355N, I2 10-L485, S 255-S460, X42-X70
- ASTM: A 131, A106/A515/A 714, A283/A285/A414/A662/A372, A369/A210/ A106, A516/A255/A 333/ A350

**Features and Applications**

- ELCOR B 70 SC is high-basidity flux-cored wire
- Extremely crack resistant weld metal conditioned by the basic slag
- High mechanical properties are easily obtained when used in single-sided welding operations using a ceramic back-up
- Weld has X-ray quality with low spatter formation. Well-suited for joining high carbon steels and when welding critical mixed base metal combinations
- Ideal metallurgical choice for repair welding and production as well as for use as a buffer layer
- Shielding gas; CO<sub>2</sub> or M21

**Welding Positions**

**Current Type**

FCAW / D.C. (+)

**Operating Data**

Product Code	Diameter (mm) / (inch)		Weight (Kg)	Package Type
6011100258	1.20	0.047"	15	BS 300

Approvals: CE, SEPRO, GOST-R



### Standards

TS EN ISO 17632-A	: T 42 A Z B M 3
EN ISO 17632-A	: T 42 A Z B M 3
AWS A5.20	: E 70 T-5M

### Chemical Composition of Weld Metal (Typical)

C	Si	Mn
0.03	0.10	0.35

### Mechanical Properties

Heat Treatment	Yield Strength (N/mm <sup>2</sup> )	Tensile Strength (N/mm <sup>2</sup> )	Impact Strength (ISO-V/-30°C)	Elongation ((L <sub>0</sub> =5d <sub>0</sub> ) (%))
AW	min. 420	500- 640	min. 47 J	min. 22

AW: as welded

### Typical Base Material Grades

- Armco Iron and mild steels.

### Features and Applications

- Suitable for use in welding of Armco Iron and mild steels. Applicability in welding of galvanized tanks made of Armco Iron
- Suitable for automation
- Shielding gas: M21

### Welding Positions



### Current Type

FCAW / D.C. (+)

### Operating Data

Product Code	Diameter (mm) / (inch)		Weight (Kg)	Package Type
3010500226	1.20	0.062"	15	BS 300

Approvals: CE, SEPRO, GOST-R

**Standards**

TS EN ISO 17632-A	: T 46 5 M M 3
EN ISO 17632-A	: T 46 5 M M 3
AWS A5.18	: E 70 C-6 M

**Chemical Composition of  
Weld Metal % (Typical)**

C	Si	Mn
0.05	0.65	1.60

**Mechanical Properties**

Heat Treatment	Yield Strength (N/mm <sup>2</sup> )	Tensile Strength (N/mm <sup>2</sup> )	Impact Strength (ISO-V/-50°C)	Elongation ((L <sub>0</sub> =5d <sub>0</sub> ) (%))
AW	min. 460	530- 650	min. 47 J	min. 22

AW: as welded

**Typical Base Material Grades**

- S235JR, S275JR, S235J2G3-S355J2G3, P 235T1-P355T1, P235T2-P355T2, L210NB-L415NB, L290MB-L415MB, P235G1TH, P255G1TH, P235GH-P355GH, P295GH, S235JRS1-S235J4S , S315G1S-S355G3S, S255N-S420N, S255NL-S355NL, GE200-GE260, X42-X60

**Features and Applications**

- Suitable for butt and fillet welding. Better arc stability and wider optimum current range for spray transfer arc with less spattering than solid wire
- Shielding gas M21

**Welding Positions**

**Current Type**

FCAW / D.C. (+)

**Operating Data**

Product Code	Diameter (mm) / (inch)		Weight (Kg)	Package Type
	mm	inch		
3010500249	1.20	0.047"	15	BS 300
3010500251	1.60	0.062"	15	BS 300

**Approvals:** ELCOR M 70 (M21): BV, ABS, CE, GOST-R, SEPRO

**Standards**

TS EN ISO 17632-A	: T 46 6 M M 1 H5
EN ISO 17632-A	: T 46 6 M M 1 H5
AWS A5.18	: E 70 C-6 M H4

**Chemical Composition of  
Weld Metal (Typical)**

C	Si	Mn
0.05	0.7	1.5

**Mechanical Properties - (Typical):** (Typical values : with M21 gas)

Heat Treatment	Yield Strength (N/mm <sup>2</sup> )	Tensile Strength (N/mm <sup>2</sup> )	Impact Strength		Elongation ((L <sub>0</sub> =5d <sub>0</sub> ) (%))
			(ISO-V/-40°C)	(ISO-V/-60°C)	
AW or SR	min. 460	530 - 650	min. 60 J	min. 47 J	min. 26

AW: as welded SR: stress relieved

**Typical Base Material Grades**

- S235JR, S275JR, S235J2G3-S355J2G3, P 235T1-P355T1, P235T2-P355T2, L210NB-L415NB, L290MB-L415MB, P235G1TH, P255G1TH, P235GH-P355GH, P295GH, S235JRS1-S235J4S, S315G1S-S355G3S, S255N-S420N, S255NL-S355NL, GE200-GE260, X42-X70

**Features and Applications**

- Good arc striking even with cold wire tip, suitable for robot applications
- Multi-pass welding without in-between cleaning
- Ideal for use in the field short arc and spray arc
- Excellent gap bridging for root welding
- Typical applications are shipbuilding, steel and pressure vessel construction, mechanical engineering and pipe work
- High-efficiency type for economic production
- Shielding Gas: M21

**Welding Positions**

**Current Type**

FCAW / D.C.(+)

**Operating Data**

Product Code	Diameter (mm) / (inch)		Weight (Kg)	Package Type
6011100390	1.20	0.047"	15	BS 300

Approvals: CE, GOST-R, SEPRO

### Standards

TS EN ISO 17632-A	: T 50 4 M M 3
EN ISO 17632-A	: T 50 4 M M 3
AWS A5.28	: E 80 C Ni 1

### Chemical Composition of Weld Metal (Typical)

C	Si	Mn	Ni
0.05	0.50	1.20	1.00

### Mechanical Properties

Heat Treatment	Yield Strength (N/mm <sup>2</sup> )	Tensile Strength (N/mm <sup>2</sup> )	Impact Strength (ISO-V/-45°C)	Elongation ((L <sub>0</sub> =5d <sub>0</sub> ) (%))
AW	min. 500	560 - 720	min. 47 J	min. 24

AW: as welded

### Features and Applications

- Suitable for automation welding applications
- It is metal cored wire
- It has soft arc, deep penetration, good bead features
- Suitable for butt and fillet welding
- Shielding gases: M21 (Ar+%5-25CO<sub>2</sub>)

### Welding Positions



### Current Type

FCAW / D.C. (+)

### Operating Data

Product Code	Diameter (mm) / (inch)		Weight (Kg)	Package Type
3010500331	1.20	0.047"	15	BS 300
3010500332	1.40	0.055"	15	BS 300
3010500335	1.40	0.055"	200	BIG PACK

Approvals: CE, GOST-R, SEPRO

**Standards**

TS EN ISO 17632-A	: T 46 4 1Ni P C 1
EN ISO 17632-A	: T 46 4 1Ni P C 1
AWS A5.29	: E81 T1-Ni1 C

**Chemical Composition of  
Weld Metal (Typical)**

C	Si	Mn	Ni
0.05	0.5	1.30	0.90

**Mechanical Properties - (Typical):** (With CO<sub>2</sub> gas)

Heat Treatment	Yield Strength (N/mm <sup>2</sup> )	Tensile Strength (N/mm <sup>2</sup> )	Impact Strength		Elongation ((L <sub>0</sub> =5d <sub>0</sub> ) (%))
			(ISO-V/-40°C)	(ISO-V/-60°C)	
AW	min. 460	560 - 690	50 J	80 J	min. 24

AW: as welded

**Typical Base Material Grades**

- EN: S 185, S235-S355, P 235 GH, P 265 GH, P 295 GH, P 235 T1/T1-P 355 N, L210-L485, S255-S500 (NL1,2), X 42-X80  
ASTM: A 131, A 106/A515/A714, A 283/A285/A414/A662/A372, A369/A210/A106/A516/A573/A707, A516/A255/ A299/ A333/ A350/ A612

**Features and Applications**

- Rutile type flux cored welding wire with good toughness in mild and 490-550 MPa high tensile steels at low service temperatures
- Suitable for butt and fillet welding in all positions
- You can get smooth arc, and low spatter, good weldability
- Shielding Gas: CO<sub>2</sub>

**Welding Positions**

**Current Type**

FCAW / D.C.(+)

**Operating Data**

Product Code	Diameter (mm) / (inch)		Weight (Kg)	Package Type
3010500337	1.20	0.047"	15	BS 300

Approvals: ABS, CE, GOST-R, SEPRO, TL

### Standards

TS EN ISO 17632-A	: T50 3 1Ni P M 1 H5 / T 46 4 1Ni P C 1 H5
EN ISO 17632-A	: T50 3 1Ni P M 1 H5 / T 46 4 1Ni P C 1 H5
AWS A5.29	: E 81T1-Ni1C, Ni1M H 4

### Chemical Composition of Weld Metal (Typical)

C	Si	Mn	Ni
0.05	0.5	1.30	0.90

### Mechanical Properties - (Typical): (With CO<sub>2</sub> gas)

Heat Treatment	Yield Strength (N/mm <sup>2</sup> )	Tensile Strength (N/mm <sup>2</sup> )	Impact Strength		Elongation ((L <sub>0</sub> =5d <sub>0</sub> ) (%))
			(ISO-V/-30°C) (with M21 gas)	(ISO-V/-40°C) (with CO <sub>2</sub> gas)	
AW	min. 460	530 - 680	min. 47 J	min. 47 J	min. 22

AW: as welded

### Typical Base Material Grades

- EN: S 185, S235-S355, P 235 GH, P 265 GH, P 295 GH, P 235 T1/T1-P 355 N, L210-L485, S255-S500 (NL1,2), X 42-X80
- ASTM: A 131, A 106/A515/A714, A 283/A285/A414/A662/A372, A369/A210/A106/A516/A573/A707, A516/A255/ A299/ A333/ A350/ A612

### Features and Applications

- Micro-alloy rutile flux-cored wire with rapidly solidifying slag for CO<sub>2</sub> and Ar+CO<sub>2</sub> mix.
- Excellent weld puddle manipulation, superior all-position welding
- Using temperature up to -60°C
- Particularly suited for MAG orbital welding applications and all-position welding on ceramic backing. Low spatter loss, easy slag removal
- CTOD tested for offshore applications
- Shielding Gases: CO<sub>2</sub> or M21

### Welding Positions



### Current Type

FCAW / D.C.(+)

### Operating Data

Product Code	Diameter (mm) / (inch)		Weight (Kg)	Package Type
6011100264	1.20	0.047"	15	D 300

Approvals: CE, GOST-R, SEPRO

**Standards**

TS EN ISO 18276-A	: T 62 4 Mn 1.5 Ni PC 1
EN ISO 18276-A	: T 62 4 Mn 1.5 Ni PC 1
AWS A5.29	: E91T1 - K2CJ

**Chemical Composition of  
Weld Metal (Typical)**

C	Si	Mn	Ni
0.08	0.5	1.20	1.70

**Mechanical Properties - (Typical):** (With CO<sub>2</sub> gas)

Heat Treatment	Yield Strength (N/mm <sup>2</sup> )	Tensile Strength (N/mm <sup>2</sup> )	Impact Strength		Elongation ((L <sub>0</sub> =5d <sub>0</sub> ) (%))
			(ISO-V/-20°C)	(ISO-V/-40°C)	
AW	min. 620	690 - 890	min. 62 J	min. 47 J	min. 18

AW: as welded

**Typical Base Material Grades**

- S380N-S500N, S355NH-S460NH, S380NL-500NL

**Features and Applications**

- Rutile type flux cored wire for 550-620 N/mm<sup>2</sup> high tensile strength steel for low temperature service
- Suitable for butt and fillet welding all positions
- Excellent impact value at low temperatures down to -40°C
- Shielding gas: CO<sub>2</sub>

**Welding Positions**

**Current Type**

FCAW / D.C.(+)

**Operating Data**

Product Code	Diameter (mm) / (inch)		Weight (Kg)	Package Type
3010500348	1.20	0.047"	15	D 300

**Approvals:** ABS, GOST-R, SEPRO

**Standards**

TS EN ISO 18276-A	: T 62 4 Mn 1.5 Ni PC 1 H5
EN ISO 18276-A	: T 62 3 Mn 1.5 Ni P M 1 H5
AWS A5.29	: E 91 T1 - K2C, -K2M H4

**Chemical Composition of  
Weld Metal (Typical)**

C	Si	Mn	Ni	Mo
0.07	0.5	1.40	1.70	0.20

**Mechanical Properties - (Typical):** (With M21 gas)

Heat Treatment	Yield Strength (N/mm <sup>2</sup> )	Tensile Strength (N/mm <sup>2</sup> )	Impact Strength		Elongation ((L <sub>0</sub> =5d <sub>0</sub> ) (%))
			(ISO-V/-30°C) (with M21 gas)	(ISO-V/-40°C) (with CO <sub>2</sub> gas)	
AW	min. 620	690 - 890	min. 47 J	min. 47 J	min. 18

AW: as welded

**Typical Base Material Grades**

- S380N-S500N, S355NH-S460NH, S380NL-500NL

**Features and Applications**

- Rutile type flux cored wire for especially 550-620 N/mm<sup>2</sup> high tensile strength steel at low temperature service
- Suitable for butt and fillet welding all positions
- Excellent impact value at low temperatures down to -40°C
- Shielding Gas: M21 or CO<sub>2</sub>

**Welding Positions**

**Current Type**

FCAW / D.C.(+)

**Operating Data**

Product Code	Diameter (mm) / (inch)		Weight (Kg)	Package Type
	mm	inch		
6011100265	1.20	0.047"	15	D 300

**Approvals:** GOST-R, SEPRO



**Standards**

TS EN ISO 18276-A	: T 69 4 Mn2.5Ni P C 1
EN ISO 18276-A	: T 69 4 Mn2.5Ni P C 1
AWS A5.29	: E 111 T1 - GC

**Chemical Composition of  
Weld Metal (Typical)**

C	Si	Mn	Ni	Mo
0.08	0.5	1.70	2.10	0.20

**Mechanical Properties - (Typical):** (With CO<sub>2</sub> gas)

Heat Treatment	Yield Strength (N/mm <sup>2</sup> )	Tensile Strength (N/mm <sup>2</sup> )	Impact Strength (ISO-V/-40°C)	Elongation ((L <sub>0</sub> =5d <sub>0</sub> ) (%))
AW	min. 690	770 - 940	min. 47 J	min. 17

AW: as welded

**Typical Base Material Grades**

- S690Q , L690M, N-A-XTRA, USS-T1, BH 70V, HY100,
- ASTM A514Gr.F
- High alloyed structural steels, fine grained steels.

**Features and Applications**

- Rutile type flux cored wire which provides an exceptionally smooth and stable arc, low spatter.
- Applications of single and multipass welding of high strength low alloy steels such as HY-80 and HY-100
- Shielding gas: CO<sub>2</sub>

**Welding Positions**

**Current Type**

FCAW / D.C.(+)

**Operating Data**

Product Code	Diameter (mm) / (inch)		Weight (Kg)	Package Type
3010500354	1.20	0.047"	15	BS 300

Approvals: ABS, GOST-R, SEPRO

### Standards

TS EN ISO 18276-A	: T 69 4 Mn2,5Ni P C 1 H5 / T 69 3 Mn2,5 Ni P M 1 H5
EN ISO 18276-A	: T 69 4 Mn2,5Ni P C 1 H5 / T 69 3 Mn2,5 Ni P M 1 H5
AWS A5.29	: E 111 T1-GC ,GM H4 (mod.)

### Chemical Composition of Weld Metal (Typical)

C	Si	Mn	Ni	Mo
0.08	0.5	1.70	2.00	0.30

### Mechanical Properties - (Typical): (With M21 gas)

Heat Treatment	Yield Strength (N/mm <sup>2</sup> )	Tensile Strength (N/mm <sup>2</sup> )	Impact Strength		Elongation ((L <sub>0</sub> =5d <sub>0</sub> ) (%))
			(ISO-V/-30°C) (with M21 gas)	(ISO-V/-40°C) (with CO <sub>2</sub> gas)	
AW	min. 690	770 - 940	min. 47 J	min. 47 J	min. 17

AW: as welded

### Typical Base Material Grades

- S690Q, L690M, N-A-XTRA, USS-T1, BH 70V, HY100, ASTM A514Gr.F,
- High alloyed structural steels, fine grained steels.

### Features and Applications

- ELCOR R 110 SC rutile type flux cored wire which provides an exceptionally smooth and stable arc, low spatter
- Applications of single and multipass welding of high strength low alloy steels, such as HY-80, and HY-100. Shielding Gas: M21 or CO<sub>2</sub>

### Welding Positions



### Current Type

FCAW / D.C.(+)

### Operating Data

Product Code	Diameter (mm) / (inch)		Weight (Kg)	Package Type
	mm	inch		
6011100262	1.20	0.047"	15	D 300

Approvals: GOST-R , SEPRO

**Standards**

TS EN ISO 18276-A	: T 55 6 Mn2Ni M M 1 H5
EN ISO 18276-A	: T 55 6 Mn2Ni M M 1 H5
AWS A5.28	: E 80 C-Ni2 H4

**Chemical Composition of  
Weld Metal (Typical)**

C	Si	Mn	Ni
0.05	0.6	1.4	2.0

**Mechanical Properties - (Typical):** (With M21 gas)

Heat Treatment	Yield Strength (N/mm <sup>2</sup> )	Tensile Strength (N/mm <sup>2</sup> )	Impact Strength		Elongation (L <sub>0</sub> =5d <sub>0</sub> ) (%)
			(ISO-V/-40°C)	(ISO-V/-60°C)	
AW	min. 550	640 - 820	min. 80 J	min. 47 J	min. 24

AW: as welded

**Typical Base Material Grades**

- Pipe Steels: P235T1/T2-P355N, L210-L485, ASTM A 537M
- Fine grained structural steels: S255(NL1/2) - S550 (QU1)
- Ship building steels :15 NiCrMo10-6 (HY 80), ASTM G18NiCrMo12-6 HYB0, ASTM A543M-93 B,C
- Pipeline Steels : API X42 - X80

**Features and Applications**

- Good arc restriking even with cold wire tip, suitable for robot applications
- Ideal for use in the field short arc and spray arc
- Excellent gap bridging for root welding
- High-efficiency type for economic production
- Shielding Gas: M21

**Welding Positions**

**Current Type**

FCAW / D.C.(+)

**Operating Data**

Product Code	Diameter (mm) / (inch)		Weight (Kg)	Package Type
6011100016	1.20	0.047"	15	D 300

**Approvals:** GOST-R , SEPRO

### Standards

TS EN ISO 18276-A	: T 55 4 1NiMo M M 3 H5
EN ISO 18276-A	: T 55 4 1NiMo M M 3 H5
AWS A5.28	: E 90C-K3M H4
AWS A5.29	: E 91 T1-G

### Chemical Composition of Weld Metal (Typical)

C	Si	Mn	Ni	Mo
0.05	0.40	1.20	1.00	0.50

### Mechanical Properties - (Typical): (With M21 gas)

Heat Treatment	Yield Strength (N/mm <sup>2</sup> )	Tensile Strength (N/mm <sup>2</sup> )	Impact Strength		Elongation ((L <sub>0</sub> =5d <sub>0</sub> ) (%))
			(ISO-V/-20°C)	(ISO-V/-40°C)	
AW	min.560	650 - 750	min.60 J	min.47 J	min.17
SR	min.540	630 - 710	min.60 J	min.47 J	min.17

AW: as welded SR: stress relieved

### Typical Base Material Grades

- HY-80 and HY 100 steels

### Features and Applications

- Metal type flux-cored wire
- Good arc striking even with cold wire tip, suitable for robot applications: Multi pass welding without in-between cleaning: Usable in the field short arc and spray arc: Excellent gap bridging for root welding: High-efficiency type for economic production: Typical applications are crane, steel, vessel and apparatus construction
- Shielding Gas: M21

### Welding Positions



### Current Type

FCAW / D.C.(+)

### Operating Data

Product Code	Diameter (mm) / (inch)		Weight (Kg)	Package Type
6011100261	1.20	0.047"	15	BS 300

Approvals: GOST-R, SEPRO

**Standards**

TS EN ISO 18276-A	: T 69 6 Mn2NiCrMo M M 1 H5
EN ISO 18276-A	: T 69 6 Mn2NiCrMo M M 1 H5
AWS A5.28	: E 110 C-K4 H4

**Chemical Composition of  
Weld Metal (Typical)**

C	Si	Mn	Cr	Ni	Mo
0.05	0.40	1.60	0.5	2.2	0.50

**Mechanical Properties - (Typical):** (With M21 gas)

Heat Treatment	Yield Strength (N/mm <sup>2</sup> )	Tensile Strength (N/mm <sup>2</sup> )	Impact Strength			Elongation ((L <sub>0</sub> =5d <sub>0</sub> ) (%))
			(ISO-V/-20°C)	(ISO-V/-40°C)	(ISO-V/-60°C)	
AW	min. 690	770 - 940	min. 80 J	min.75 J	min.75 J	min.17

AW: as welded

**Typical Base Material Grades**

- HY-80 and HY-100 steels

**Features and Applications**

- ELCOR M NiCrMo SC metal cored wire without slag for Ar+CO<sub>2</sub> mix is a metal cored wire which provides an exceptionally smooth and stable arc, low spatter and minimal slag coverage
- Shielding Gas: M21

**Welding Positions**

**Current Type**

FCAW / D.C.(+)

**Operating Data**

Product Code	Diameter (mm) / (inch)		Weight (Kg)	Package Type
6011100017	1.20	0.047"	15	BS 300

**Approvals:** GOST-R, SEPRO

### Standards

TS EN ISO 17632-B : T 55 3 T1-1CA-NCC1
EN ISO 17632-B : T 55 3 T1-1CA-NCC1
AWS A5.29 : E 81 T1-W2 C

### Chemical Composition of Weld Metal (Typical)

C	Si	Mn	Ni	Cr	Cu
0.05	0.5	1.3	0.5	0.55	0.4

### Mechanical Properties - (Typical)

Heat Treatment	Yield Strength (N/mm <sup>2</sup> )	Tensile Strength (N/mm <sup>2</sup> )	Impact Strength (ISO-V/-30°C)	Elongation ((L <sub>0</sub> =5d <sub>0</sub> ) (%))
AW	min. 470	550 - 690	min. 47 J	min. 19

AW: as welded

### Typical Base Material Grades

- DIN: COR-TEN A-B-C
- EN: S235JRW-S355JRW, 9CrNiCuP3-2-4, S255-S460,
- ASTM: A 242/A441, A423/ A 588, A516/ A 255/ A 333/ A 350 / A612

### Features and Applications

- Rutile flux-cored wire
- Typical application is weathering grades of steels
- Excellent weld puddle manipulation, superior all-position welding
- Particularly suited for mechanized MAG welding and all-position welding on ceramic backing
- Low spatter with easy slag removal
- Shielding Gas: CO<sub>2</sub>

### Welding Positions



### Current Type

D.C.(+)

### Operating Data

Product Code	Diameter (mm) / (inch)		Weight (Kg)	Package Type
3010500364	1.20	0.047"	15	BS 300

Approvals: GOST-R, CE, SEPRO

### Standards

TS EN ISO 17632-A	: T 46 2 Z P C 1 H5 / T 46 2 Z P M 1 H5
EN ISO 17632-A	: T 46 2 Z P C 1 H5 / T 46 2 Z P M 1 H5
AWS A5.29	: E81T1-G H4

### Chemical Composition of Weld Metal (Typical)

C	Si	Mn	Ni	Cu
0.05	0.50	1.30	1.2	0.5

### Mechanical Properties - (Typical): (With M21 gas)

Heat Treatment	Yield Strength (N/mm <sup>2</sup> )	Tensile Strength (N/mm <sup>2</sup> )	Impact Strength		Elongation ((L <sub>0</sub> =5d <sub>0</sub> ) (%))
			(ISO-V/-20°C)	(ISO-V/-40°C)	
AW	min. 460	550 - 650	min. 60 J	min. 47 J	min. 22

AW: as welded

### Typical Base Material Grades

- DIN: COR-TEN A-B-C
- EN: S235JRW-S355JRW, 9CrNiCuP3-2-4, S255-S460,
- ASTM: A 242/A441, A423/ A 588, A516/ A255/ A 333/ A350 / A612

### Features and Applications

- Micro-alloy rutile flux-cored wire with rapidly solidifying slag for Ar+CO<sub>2</sub> mix
- Typical application is weathering grades of steels
- Excellent weld puddle manipulation, superior all-position welding
- Particularly suited for mechanized MAG welding and all-position welding on ceramic backing.
- Low spatter with easy slag removal
- Shielding Gas: M21 or CO<sub>2</sub>

### Welding Positions



### Current Type

D.C.(+)

### Operating Data

Product Code	Diameter (mm) / (inch)		Weight (Kg)	Package Type
6011100027	1.20	0.047"		D 300

Approvals: GOST-R, CE, SEPRO

**Standards**

TS EN ISO 17632-A : T 46 2 Mo R C 2
EN ISO 17632-A : T 46 2 Mo R C 2
AWS A5.29 : E 81 T1-A1C

**Chemical Composition of  
Weld Metal (Typical)**

C	Si	Mn	Mo
0.05	0.50	1.25	0.50

**Mechanical Properties - % (Typical)**

Heat Treatment	Yield Strength (N/mm <sup>2</sup> )	Tensile Strength (N/mm <sup>2</sup> )	Impact Strength		Elongation ((L <sub>0</sub> =5d <sub>0</sub> ) (%))
			(RT)	(ISO-V/-20°C)	
AW	min.470	550 - 650	min.70 J	min.47 J	min.22
SR (620°C / 1h, air cooled at 300°C)	min.470	550 - 680	min.70 J	min.47 J	min.21

AW: as welded SR: stress relieved RT: room temperature

**Typical Base Material Grades**

- DIN: HI, HII, 17Mn4, 19Mn5, 15Mo3, 16 Mo 3
- EN: P 235 GH, P 265 GH, P 295 GH, 16 Mo 3, P 235 T1F2-P355 N, L210-L485 , S255-L485
- ASTM: A283, A285, A414, A662, A372, A204, A 369, A210, A106, A 516, A 255, A 333, A 350, A 612

**Features and Applications**

- Rutile type flux-cored wire
- Typical applications are vessel and steel construction, mechanical engineering and pipe work.
- Good arc restriking even with cold wire tip, suitable for robot applications
- Multi-pass welding without in-between cleaning
- Ideal for use in the field short arc and spray arc
- Excellent gap bridging for root welding
- High-efficiency type for economic production environments
- Shielding Gas: CO<sub>2</sub>

**Welding Positions**

**Current Type**

D.C.(+)

**Operating Data**

Product Code	Diameter (mm) / (inch)		Weight (Kg)	Package Type
3010500367	1.20	0.047"	15	BS 300

Approvals: GOST-R, CE, SEPRO



**Standards**

TS EN ISO 17632-A	: T 46 2 Mo M M1
EN ISO 17632-A	: T 46 2 Mo M M1
AWS A5.29	: E81 T1 -A1 M

**Chemical Composition of  
Weld Metal (Typical)**

C	Cr	Mn	Mo
0.05	0.03	1.00	0.50

**Mechanical Properties - (Typical)**

Heat Treatment	Yield Strength (N/mm <sup>2</sup> )	Tensile Strength (N/mm <sup>2</sup> )	Impact Strength (ISO-V/-20°C)	Elongation ((L <sub>o</sub> =5d <sub>o</sub> ) (%))
SR 620°C / 1h	470	550 - 680	min. 47	min. 20

**Typical Base Material Grades**

- DIN: HI, HII, 17Mn4, 19Mn5, 15Mo3, 16Mo3
- EN: P 235 GH, P 265 GH, P 295 GH, 16 Mo 3, P 235 T1/T2-P355 N, L210-L485, S255-L485
- ASTM: A283, A285, A414, A662, A372, A204, A369, A210, A106, A516, A255, A333, A350, A612

**Features and Applications**

- Metal type flux-cored wire which provides a smooth and stable arc
- Excellent weldability for vertical up position (PG) and overhead fillet (PD) position
- Pressure vessels and steel constructions are typical applications
- Shielding gas: Ar+CO<sub>2</sub> mix

**Welding Positions**

**Current Type**

FCAW D.C (+)

**Operating Data**

Product Code	Diameter (mm) / (inch)		Weight (Kg)	Package Type
3010500386	1.20	0.047"	15	BS 300

**Approvals:** SEPRO, GOST-R, CE

### Standards

TS EN ISO 17632-A	: T 46 2 Mo R C 2 H5
EN ISO 17632-A	: T 46 2 Mo R C 2 H5
AWS A5.29	: E 81 T1 -A1C H4

### Chemical Composition of Weld Metal (Typical)

C	Si	Mn	Mo
0.05	0.50	1.30	0.50

### Mechanical Properties - (Typical): (With CO<sub>2</sub> gas)

Heat Treatment	Yield Strength (N/mm <sup>2</sup> )	Tensile Strength (N/mm <sup>2</sup> )	Impact Strength (RT)	Elongation ((L <sub>0</sub> =5d <sub>0</sub> ) (%))
AW	min.470	550 - 660	min.70 J	min.22
SR (620°C / 1h, air cooled at 300°C)	min.460	550 - 680	min.70 J	min.21

AW: as welded SR: stress relieved RT: room temperature

### Typical Base Material Grades

- DIN: HI, HII, 17Mn4, 19Mn5, 15Mo3, 16 Mo 3
- EN: P 235 GH, P 265 GH, P 295 GH, 16 Mo 3, P 235 T1/T2-P355 N, L210-L485, 5255-L485
- ASTM: A283, A285, A414, A662, A372, A204, A 369, A210, A106, A 516, A 255, A 333, A 350, A 612

### Features and Applications

- Rutile type flux-cored wire
- Typical applications are vessel and steel construction, mechanical engineering and pipe work
- Good arc restriking even with cold wire tip, suitable for robot applications
- Multi-pass welding without in-between cleaning
- Ideal for use in the field short arc and spray arc
- Excellent gap bridging for root welding
- High-efficiency type for economic production environments
- Shielding Gas: CO<sub>2</sub>

### Welding Positions



### Current Type

D.C.(+)

### Operating Data

Product Code	Diameter (mm) / (inch)		Weight (Kg)	Package Type
6011100266	1.20	0.047"	16	D 300

Approvals: GOST-R, CE, SEPRO

### Standards

TS EN ISO 17632-A	: T46 2 Mo M M 1 H5
EN ISO 17632-A	: T46 2 Mo M M 1 H5
AWS A5.29	: E81 T1 -A1 H4
AWS A5.28	: E80 C-D2 H4

### Chemical Composition of Weld Metal (Typical)

C	Si	Mn	Mo
0.05	0.50	1.30	0.50

### Mechanical Properties - (Typical): (Typical values : with M21 gas)

Heat Treatment	Yield Strength (N/mm <sup>2</sup> )	Tensile Strength (N/mm <sup>2</sup> )	Impact Strength (RT)	Elongation ((L <sub>0</sub> =5d <sub>0</sub> ) (%))
AW	min. 470	550 - 650	min. 70 J	min. 22
SR	min. 540	630 - 710	min. 70 J	min. 21

AW: as welded SR: stress relieved RT: room temperature

### Typical Base Material Grades

- DIN: H1, H11, 17Mn4, 19Mn5, 15Mo3, 16 Mo 3
- EN: P 235 GH, P 265 GH, P 295 GH, 16 Mo 3, P 235 T1/T2-P355 N, L210-L485, S255-L485
- ASTM: A283, A285, A414, A662, A372, A204, A 369, A210, A106, A 516, A 255, A 333, A 350, A 612

### Features and Applications

- Metal cored wire without slag for Ar+CO<sub>2</sub> mix
- Typical applications are vessel and steel construction, mechanical engineering and pipe work
- Good arc restriking even with cold wire tip, suitable for robot applications
- Multi pass welding without in-between cleaning
- Ideal for use in the field short arc and spray arc
- Excellent gap bridging for root welding
- High-efficiency type for economic production environments
- Shielding Gas: M21

### Welding Positions



### Current Type

D.C (+)

### Operating Data

Product Code	Diameter (mm) / (inch)		Weight (Kg)	Package Type
6011100015	1.20	0.047"	15	BS 300

Approvals: GOST-R, CE, SEPRO

## Standards

TS EN ISO 21952-A	: W Z Cr Mo1Si
EN ISO 21952-A	: W Z Cr Mo1Si
AWS A5.28	: E80C-B2(mod.)

## Chemical Composition of Weld Metal (Typical)

C	Si	Mn	Mo	Cr
0.06	0.55	0.90	0.50	1.0

## Mechanical Properties - (Typical)

Heat Treatment	Yield Strength (N/mm <sup>2</sup> )	Tensile Strength (N/mm <sup>2</sup> )	Impact Strength (ISO-V/-40°C)	Elongation ((L <sub>o</sub> =5d <sub>o</sub> ) (%))
680°C / 2h	min. 355	min. 550	min. 47 J	min. 20

## Typical Base Material Grades

- 13CrMo4-5 , 15CrMo5 , 42CrMo4, 16CrMoV4, 25CrMo4, 24CrMo5, G22CrMo5-4 , G17CrMo5-5

## Features and Applications

- Recommended for welding of Cr-Mo alloyed steels which are used for the production of boilers, tubes, pipes and nitride steels
- Weld metal is resistant to temperatures up to +570°C
- Suitable for step-cooling applications
- Shielding Gas: 100% Argon

## Welding Positions



## Current Type

TIG D.C (-)

## Operating Data

Product Code	Diameter (mm) / (inch)		Weight (Kg)
3010600001	2.40x1000	3/32x39"	5

Approvals: GOST-R, CE, SEPRO

### Standards

TS EN ISO 17634-A	: T CrMo1 R C 2
EN ISO 17634-A	: T CrMo1 R C 2
AWS A5.29	: E81 T1-B2C

### Chemical Composition of Weld Metal (Typical)

C	Si	Mn	Cr	Mo
0.06	0.50	1.20	1.20	0.50

### Mechanical Properties - (Typical): (With M21 gas)

Heat Treatment	Yield Strength (N/mm <sup>2</sup> )	Tensile Strength (N/mm <sup>2</sup> )	Impact Strength (RT)	Elongation ((L <sub>0</sub> =5d <sub>0</sub> ) (%))
680°C / 1h	min. 460	550 - 690	min. 80 J	min. 19

RT: room temperature

### Typical Base Material Grades

- DIN: 13 CrMo 44, 24 CrMo 5
- Cast Steels : GS 17CrMo55, GS 22CrMo54, G17CrMo5-5, G22CrMo5-4
- EN : 13 CrMo 4-5, G 17 CrMo 5-5, G 22 CrMo 5-4
- ASTM: A 182, A 387, A217, A 387 Gr. 11-12

### Features and Applications

- Rutile type flux-cored wire
- Typical applications are vessel and steel construction, mechanical engineering and pipe work
- Good arc restriking even with cold wire tip, suitable for robot applications
- Multi-pass welding without in-between cleaning
- Ideal for use in the field short arc and spray arc
- Excellent gap bridging for root welding
- High-efficiency type for economic production environments
- Shielding gas: CO<sub>2</sub>

### Welding Positions



### Current Type

D.C (+)

### Operating Data

Product Code	Diameter (mm) / (inch)		Weight (Kg)	Package Type
3010500121	1.20	0.047"	15	BS 300

Approvals: GOST-R, CE, SEPRO

**Standards**

TS EN ISO 17634-A	: T CrMo1 M M 1 H5
EN ISO 17634-A	: T CrMo1 M M 1 H5
AWS A5.28	: E 80 C-B2-H4

**Chemical Composition of  
Weld Metal (Typical)**

C	Si	Mn	Cr	Mo
0.05	0.30	1.40	1.1	0.5

**Mechanical Properties - (Typical):** (With M21 gas)

Heat Treatment	Yield Strength (N/mm <sup>2</sup> )	Tensile Strength (N/mm <sup>2</sup> )	Impact Strength (RT)	Elongation ((L <sub>0</sub> =5d <sub>0</sub> ) (%))
AW	min. 480	580 - 700	min. 80 J	min. 20

**Typical Base Material Grades**

- DIN: 13 CrMo 44, 24 CrMo 5
- EN: 13 CrMo 4-5, G 17 CrMo 5-5, G 22 CrMo 5-4
- ASTM: A 182, A387, A 217

**Features and Applications**

- Metal cored wire without slag for Ar+CO<sub>2</sub> mix
- Typical applications are vessel and steel construction, mechanical engineering and pipe work
- Good arc striking even with cold wire tip, suitable for robot applications
- Multi-pass welding without in-between cleaning
- Ideal for use in the field short arc and spray arc
- Excellent gap bridging for root welding
- High-efficiency type for economic production environments
- Shielding Gas: M21

**Welding Positions**

**Current Type**

D.C (+)

**Operating Data**

Product Code	Diameter (mm) / (inch)		Weight (Kg)	Package Type
6011100260	1.20	0.047"	16	BS 300

**Approvals:** GOST-R, CE, SEPRO

**Standards**

TS EN ISO 17634-A	: T CrMo2 R C 1 / T CrMo2 R M 1
EN ISO 17634-A	: T CrMo2 R C 1 / T CrMo2 R M 1
AWS A5.29	: E 91T1 - B3C/B3M

**Chemical Composition of  
Weld Metal (Typical)**

C	Si	Mn	Cr	Mo
0.05	0.45	1.00	2.40	1.00

**Mechanical Properties - (Typical)**

Heat Treatment	Yield Strength (N/mm <sup>2</sup> )	Tensile Strength (N/mm <sup>2</sup> )	Impact Strength (ISO-V/+20°C)	Elongation ((L <sub>0</sub> =5d <sub>0</sub> ) (%))
690°C / 1h	min. 540	620 - 760	min. 47 J	min. 18

**Typical Base Material Grades**

- 2.25% Cr - 1% Mo steels such as ASTM A387 or P21/P22 pipes.

**Features and Applications**

- Rutile type flux cored wire for all position welding
- Excellent weldability for vertical up position (PG) and overhead fillet (PD) position
- Good arc stability and weldability
- Shielding gas: 100% CO<sub>2</sub> or Ar+CO<sub>2</sub> mix

**Welding Positions**

**Current Type**

FCAW D.C (+)

**Operating Data**

Product Code	Diameter (mm) / (inch)		Weight (Kg)	Package Type
3010500387	1.20	0.047"	15	BS 300

Approvals: SEPRO, GOST-R

### Standards

### Chemical Composition of Weld Metal (Typical)

TS EN ISO 17634-A	: T CrMo 2 B M 3 H5/T CrMo2 B C 3 H5
EN ISO 17634-A	: T CrMo 2 B M 3 H5/T CrMo2 B C 3 H5
AWS AS.29	: E 90 T5-B3-H4

C	Si	Mn	Cr	Mo
0.07	0.30	1.00	2.3	1.1

### Mechanical Properties - (Typical): (With M21 gas)

Heat Treatment	Yield Strength (N/mm <sup>2</sup> )	Tensile Strength (N/mm <sup>2</sup> )	Impact Strength			Elongation ((L <sub>0</sub> =5d <sub>0</sub> ) (%))
			RT	0°C	-15°C	
SR	min. 530	620 - 820	min.120 J	min.100 J	min.80 J	min. 18

RT: room temperature **S.R.**: stress relieved (675°-705°C/1 h)

### Typical Base Material Grades

- DIN : 10 CrMo 9 10, 10 CrSiMoV 7, 12 CrMo 9 10
- EN: 10 CrMo 9-10, 12 Cr9-10
- ASTM: A 182, A 217, A 541

### Features and Applications

- High-basicity flux-cored wire with slag for CO<sub>2</sub> and Ar+CO<sub>2</sub> mix
- Typical applications are pressure vessels
- Chemical apparatus, and steam turbine construction
- Extremely crack resistant weld metal conditioned by the basic slag in combination with very low hydrogen content
- Well suited for the economic joining of high temperature and compressed hydrogen resistant %2.25 Cr2Mo steels
- Meets requirements of step cooling by very low weld metal contaminations.
- Shielding Gas: CO<sub>2</sub> or M21

### Welding Positions



### Current Type

D.C (+)

### Operating Data

Product Code	Diameter (mm) / (inch)		Weight (Kg)	Package Type
6011100259	1.20	0.047"	15	BS 300

Approvals: GOST-R, CE, SEPRO



**Standards**

TS EN ISO 17633-A	: T 18 8 Mn P M21/C1 1
EN ISO 17633-A	: T 18 8 Mn P M21/C1 1
AWS A5.22	: E307T1-1/-4 (mod.)

**Chemical Composition of  
Weld Metal (Typical)**

C	Si	Mn	Cr	Ni
0.10	0.70	6.00	19.0	9.0

**Mechanical Properties - (Typical):** (With M21 gas)

Yield Strength (N/mm <sup>2</sup> )	Tensile Strength (N/mm <sup>2</sup> )	Impact Strength (ISO-V/+20°C)	Elongation (L <sub>0</sub> =5d <sub>0</sub> ) (%)
480	630	50 J	40

**Typical Base Material Grades**

- High-strength low alloyed and alloyed heat-treatable steels, armor steels, steels including 14 % Mn, ferritic chromium steels, heat-resistant steels, non-magnetic steels, dissimilar joints and repair welding.

**Features and Applications**

- ELOXCOR S 307 is rutile fast freezing type flux cored wire
- Work-hardening austenitic deposit in CrNiMn steel modified type 307
- Dissimilar joint , welding of steels of unknown types, armouring steels, buffering joining of 14 %Mn austenitic steels
- Service temperatures from -120°C to +300°C
- Shielding Gas: CO<sub>2</sub> or M21

**Welding Positions**

**Current Type**

D.C (+)

**Operating Data**

Product Code	Diameter (mm) / (inch)		Weight (Kg)	Package Type
6011100006	1.20	0.047"	15	D 300

**Approvals:** GOST-R, CE, SEPRO

**Standards**

TS EN ISO 17633-A	: T 19 9 L P M21/C1 1
EN ISO 17633-A	: T 19 9 L P M21/C1 1
AWS A5.22	: E 308 L T1-1/-4

**Chemical Composition of  
Weld Metal (Typical)**

C	Si	Mn	Cr	Ni
0.03	0.70	1.40	20.0	10.5

**Mechanical Properties - (Typical):** (With M21 gas)

Yield Strength (N/mm <sup>2</sup> )	Tensile Strength (N/mm <sup>2</sup> )	Impact Strength (ISO-V/-196°C)	Elongation ( $L_0=5d_0$ ) (%)
460	620	34 J	36

**Typical Base Material Grades**

- (1.4306) X2CrNi19-11, (1.4301) X5CrNi18-10, (1.4311) X2 CrNiN 18-10, (1.4312) GX10CrNi18-8)
- AISI 304-304L-304LN, 302, 321-347, ASTM: A 157, Gr C9, A 320 Gr B8C or D

**Features and Applications**

- Rutile type, rapid hardening flux cored wire
- Weld metal structure is austenitic (CrNi alloyed, 308 type)
- Used in pharmaceutical, paper and food industry
- Ferritic stainless steel, high carbon 304 and stabilized 347 grades can be welded this wire
- Weld metal has resisting between -196°C and 400°C service temperature
- Shielding Gas: CO<sub>2</sub> or M21

**Welding Positions**

**Current Type**

FCAW / D.C (+)

**Operating Data**

Product Code	Diameter (mm) / (inch)		Weight (Kg)	Package Type
6011100255	1.20	0.047"	15	D 300

**Approvals:** ELOXCOR S 308 L (CO<sub>2</sub>) : DNV-GL, GOST-R, CE, SEPRO

**Standards**

TS EN ISO 17633-A	: T 23 12 L P M21/C1 1
EN ISO 17633-A	: T 23 12 L P M21/C1 1
AWS A5.22	: E309L T1-1/-4

**Chemical Composition of  
Weld Metal (Typical)**

C	Si	Mn	Cr	Ni
0.03	0.70	1.40	23.5	13.0

**Mechanical Properties - (Typical):** (With M21 gas)

Yield Strength (N/mm <sup>2</sup> )	Tensile Strength (N/mm <sup>2</sup> )	Impact Strength (ISO-V/-60°C)	Elongation (L <sub>0</sub> =5d <sub>0</sub> ) (%)
460	580	40 J	35

**Typical Base Material Grades**

- High-strength unalloyed and heat-treatable steels, ferritic Cr and austenitic CrNi steels, austenitic Mn steels, unalloyed tempered steels, tool steels, hard manganese steels, ferritic chromium steels, austenitic nickel-chromium steels, hard-to-weld steels, similar-type austenitic steels, dissimilar metals , joining of corrosion resistant stainless steel with mild or low alloy steels, clad steels.

**Features and Applications**

- ELOXCOR S 309L is rutile fast freezing type flux cored wire
- Austenitic-ferritic deposit in over-alloyed CrNi steel type 309L, with optimised ferrite content for joining dissimilar metals
- Joining of steels with similar compositions and joining carbon steels to Stainless steels
- Buffering before cladding. Service temperatures from - 60°C to + 350°C
- Shieldin Gas: CO<sub>2</sub> or M21

**Welding Positions**

**Current Type**

D.C (+)

**Operating Data**

Product Code	Diameter (mm) / (inch)		Weight (Kg)	Package Type
6011100256	1.20	0.047"	15	D 300

**Approvals:** ELOXCOR S 309 L (CO<sub>2</sub>) : DNV-GL, GOST-R, SEPRO

**Standards**

TS EN ISO17633-A	: T Z 19 12 3 L P M21/C1 1
EN ISO 17633-A	: T Z 19 12 3 L P M21/C1 1
AWSAS.22	: E316LT1-1/-4

**Chemical Composition of  
Weld Metal (Typical)**

C	Si	Mn	Cr	Ni	Mo
0.03	0.80	1.40	19.0	12.0	2.10

**Mechanical Properties - (Typical):** (With M21 gas)

Yield Strength (N/mm <sup>2</sup> )	Tensile Strength (N/mm <sup>2</sup> )	Impact Strength (ISO-V/-110°C)	Elongation (L <sub>o</sub> =5d <sub>o</sub> ) (%)
490	600	35 J	32

**Typical Base Material Grades**

- (1.4401) X5CrNiMo 17-12-2, (1.4404) X2CrNiMo 17-12-2, (1.4435) X2CrNiMo 18-14-3, (1.4436) X3 CrNiMo 17- 13-3, (1.4571) X6 CrNiMoTi 17-12-2, (1.4580) X6 CrNiMoNb 17-12-2, (1.4583) X10 CrNiMoNb 18-12, (1.4409) GX2 CrNiMo 19-11-2
- AISI 316 L, 316 Ti, 316 Cb

**Features and Applications**

- Rutile type, rapid hardening flux cored wire
- Weld metal microstructure is austenite (CrNiMo alloyed, 316 type)
- Used in welding of high carbon and stabilized 316 grade steels, low carbon 316 L grade stainless steels, food, pharmaceutical, chemical dye and machinery and equipment industries
- Weld metal has resisting between -110°C and 400°C service temperature
- Shielding Gas: CO<sub>2</sub> or M21

**Welding Positions**

**Current Type**

FCAW / D.C (+)

**Operating Data**

Product Code	Diameter (mm) / (inch)		Weight (Kg)	Package Type
6011100257	1.20	0.047"	15	D 300

**Approvals:** ELOXCOR S 316 L (CO<sub>2</sub>) : DNV-GL , GOST-R , SEPRO

**Standards**

TS EN ISO 17633-A	: T 22 9 3 N L P M21/C 1 1
EN ISO 17633-A	: T 22 9 3 N L P M21/C 1 1
AWS A5.22	: E 2209 T1-1/-4

**Chemical Composition of  
Weld Metal (Typical)**

C	Si	Mn	Cr	Ni	Mo	N
0.03	0.80	1.40	23.0	9.0	3.20	0.14

**Mechanical Properties - (Typical):** (With M21 gas)

Yield Strength (N/mm <sup>2</sup> )	Tensile Strength (N/mm <sup>2</sup> )	Impact Strength (ISO-V/-60°C)	Elongation ((L <sub>0</sub> =5d <sub>0</sub> ) (%))
630	780	32 J	28

**Typical Base Material Grades**

- (1.4462) X2CrNiMoN 22-5-3, (1.4362) X2 CrNiN 23-4, UNS S31803, S32205, J92295, S31500, S32304, S32404

**Features and Applications**

- Rutile type and rapid hardening flux cored wire
- Weld metal microstructure is austenite - ferritic
- The weld metal has an excellent resistance to stress corrosion, cracking and pitting
- Used in duplex stainless steel and similar materials
- Shielding Gas: CO<sub>2</sub> or M21

**Welding Positions**

**Current Type**

FCAW / D.C (+)

**Operating Data**

Product Code	Diameter (mm) / (inch)		Weight (Kg)	Package Type
6011100254	1.20	0.047"	15	D 300

**Approvals:** ELOXCOR S 2209: GOST-R, CE, CLASS NK, SEPRO

### Standards

AWS A5.23 : F8A4- EC-1

### Chemical Composition of Weld Metal (Typical)

C	Si	Mn
0.05	0.3	1.5

### Mechanical Properties

Heat Treatment	Yield Strength (N/mm <sup>2</sup> )	Tensile Strength (N/mm <sup>2</sup> )	Impact Strength		Elongation (L <sub>0</sub> =5d <sub>0</sub> ) (%)
			(ISO-V/-20°C)	(ISO-V/-40°C)	
AW or SR	min.460	540 - 640	min.140 J	min.100 J	25

AW: as welded SR stress relieved

### Typical Base Material Grades

- DIN: H1, H11, 17Mn4, 19Mn5 etc.
- EN: S 185, S 235-S355, P235 GH, P 265 GH, P 295 GH, P 235 T1/T2 - P 355 N - L210-L485, S 255-S 460
- ASTM: A 131, A 106, A 515, A 714, A 283, A 285, A 414, A 662, A 372, A369, A210, A 106, A 516, A 255, A 333, A 350, A 612, X 42-X 70

### Features and Applications

- High-basicity flux cored wire for submerged arc welding
- Extremely crack resistant weld metal conditioned by the basic slag
- High mechanical properties are easily obtained when used in single sided welding operations using a ceramic back up
- Weld X-ray quality
- Well-suited for joining high carbon steels and when welding critical mixed base metal combinations
- Ideal metallurgical choice for repair welding and production as well as a buller layer
- As welding flux we recommend our type GeKa ELIFLUX BFF

### Welding Positions



### Current Type

D.C (+)

### Operating Data

Product Code	Diameter (mm) / (inch)		Package Weight (Kg)
3010400364	2.40	3/32	25
3010400365	3.20	1/8	30
3010400366	4.00	5/32	30

Approvals: GOST-R , SEPRO, CE

**Standards**

AWS A5.23 : F8A6- EC-1D

**Chemical Composition of  
Weld Metal (Typical)**

C	Si	Mn	Mo
0.05	0.3	1.5	0.5

**Mechanical Properties**

Heat Treatment	Yield Strength (N/mm <sup>2</sup> )	Tensile Strength (N/mm <sup>2</sup> )	Impact Strength				Elongation ((L <sub>0</sub> =5d <sub>0</sub> ) (%))
			RT	0°C	-20°C	-40°C	
AW	min.460	520 - 620	min.140	min.100	min.80	min.60	min.24
SR	min.460	520 - 620	min.100	min.80	min.60	min.47	min.24

AW: as welded SR stress relieved RT: room temperature

**Typical Base Material Grades**

- DIN: H1, H11, 17Mn4, 19Mn5, 15 Mo 3, 16 Mo 3
- EN: P 235 GH, P 265 GH, P 295 GH, 16 Mo 3, P 235 T1/T2, P 355 N, L290-L485, S 255-S460
- ASTM: A 283, A 285, A 414, A 662, A 372, A 204, A 369, A 210, A 106, A 516, A 255, A 333, A 350, A 612

**Features and Applications**

- Extremely crack resistant weld metal is result of high-basicity slag and very low diffusible hydrogen content
- Especially suited for multi-wire welding applications
- Typical applications are micro-alloy, basic slag flux-cored wire, for submerged-arc welding, vessel, steel and apparatus construction, production of large diameter pipes, shipbuilding

**Welding Positions**

**Current Type**

D.C (+)

**Operating Data**

Product Code	Diameter (mm) / (inch)		Package Weight (Kg)
3010400367	2.40	3/32	25
3010400368	3.20	1/8	30
3010400369	4.00	5/32	30

**Approvals:** GOST-R, CE, SEPRO

**Standards**

AWS A5.23 : F7A8 - EC - G  
 F7P8 - EC - G

**Chemical Composition of  
 Weld Metal (Typical)**

C	Si	Mn	Ni
0.10	0.3	1.4	0.9

**Mechanical Properties**

Heat Treatment	Yield Strength (N/mm <sup>2</sup> )	Tensile Strength (N/mm <sup>2</sup> )	Impact Strength (ISO-V)		Elongation ((L <sub>0</sub> =5d <sub>0</sub> ) (%))
			- 40°C	- 60°C	
AW	min.480	550 - 680	min.100 J	min.80 J	min.22
SR	min.460	530 - 660	min.120 J	min.100 J	min.24
N	min.355	480 - 560	min.100 J	min.100 J	min.26
N+A	min.355	480 - 560	min.120 J	min.100 J	min.26

AW: as welded SR: stress relieved N: normalized N+A: cooling in air

**Typical Base Material Grades**

- DIN: H1, H11, 17Mn4, 19Mn5, 15 Mo 3, 16 Mo 3
- EN: P 235 GH, P 265 GH, P 295 GH, 16 Mo 3, P 235 T1/T2, P 355 N, L290-L485, S 255-S460
- ASTM: A 283, A 285, A 414, A 662, A 372, A 204, A 369, A 210, A 106, A 516, A 255, A 333, A 350, A 612

**Features and Applications**

- Basic flux-cored wire for submerged-arc welding
- Typical applications are apparatus and vessel construction
- Extremely crack resistant weld metal conditioned by the high-basicity slag in combination with very low hydrogen content
- Well suited for the economic joining of high temperature. Resistant CrMoV-steels up to 550 C.
- Weld X-ray quality

**Welding Positions**

**Current Type**

D.C (+)

**Operating Data**

Product Code	Diameter (mm) / (inch)		Package Weight (Kg)
3010400353	3.20	1/8	30

Approvals: GOST-R, CE, SEPRO



**Standards**

AWS A5.23 : ~ EC 410 NiMo

**Chemical Composition of  
Weld Metal (Typical)**

C	Si	Mn	Cr	Ni	Mo	V
0.07	0.35	1.50	12.5	2.2	1.0	0.2

**Mechanical Properties**

Hardness (HV)	
Single Pass	3 Pass
350	400

**Typical Base Material Grades**

- Applicability in welding of martensitic and martensitic-ferritic materials used in toolsof rolling forging and steel casting operations. Continuous casting rollers particularly or iron-steel productions plants, relays, rolls, valves, used in gas/water/steam environments, flanges, compressons.

**Features and Applications**

- A tubular wire for submerged arc welding of martensitic stainless steels
- Good resistance to corrosion and thermal fatigue
- It used with GeKa ELIFLUX BSS-F flux for surfacing continuous casting, rollers
- Weld metals of martensitic micro-structure
- It is used in combination with GeKa ELIFLUX BSS-F

**Welding Positions**

**Current Type**

D.C (+)

**Operating Data**

Product Code	Diameter (mm) / (inch)		Package Weight (Kg)
3010700005	2.40	3/32	25
3010700006	2.80	7/64	200

**Approvals:** GOST-R, CE, SEPRO

### Standards

AWS A5.23 : ~ EC 410 NiMo

### Chemical Composition of Weld Metal (Typical)

C	Si	Mn	Cr	Ni	Mo	V	Nb
0.13	1.00	2.00	12.5	2.5	1.0	0.2	0.15

### Mechanical Properties

Hardness (HRC)	
Single Pass	3 Pass
40	45

### Typical Base Material Grades

- Applicability in welding of martensitic and martensitic-ferritic materials used in toolsof rolling forging and steel casting operations. Continuous casting rollers particularly or iron-steel productions plants, relays, rolls, valves, used in gas/water/steam environments, flanges, compressons

### Features and Applications

- A tubular wire for submerged arc welding of martensitic stainless steels
- Good resistance to corrosion and thermal fatigue
- It used with GeKa ELIFLUX BSS-F flux for surfacing continuous casting, rollers
- Weld metals of martensitic micro-structure
- It is used in combination with GeKa ELIFLUX BSS-F

### Welding Positions



### Current Type

D.C (+)

### Operating Data

Product Code	Diameter (mm) / (inch)		Package Weight (Kg)
3010700007	2.40	3/32	200

**Approvals:** GOST-R, CE, SEPRO

## Standards

TS EN 14700	: T Fe 7
EN 14700	: T Fe 7

## Chemical Composition of Weld Metal (Typical)

C	Cr	Mn	Si
0.05	17.0	2.0	0.7

## Mechanical Properties

Hardness (HV)
3 Pass
200

## Features and Applications

- %17 Chromium ferritic stainless steel deposit
- It is used for buffer layers before hardfacing of SUBCOR 41 NiMo LH and MH
- High resistant to combination of high temperature, corrosion and adhesive / friction wear
- Application; rolls, contionous casting rolls, shafts.It is using with submerged arc flux of Geka ELIFLUX BSS-F
- It is used in combination with GeKa ELIFLUX BSS-F

## Welding Positions



## Current Type

D.C (+)

## Operating Data

Product Code	Diameter (mm) / (inch)		Package Weight (Kg)
3010700001	2.40	3/32	25
3010700002	2.40	3/32	200

Approvals: GOST-R, CE, SEPRO

## Standards

TS EN ISO 14171-A	: S1
EN ISO 14171-A	: S1
AWS A5.17	: EL 12

## Chemical Composition of Welding Wire % (Typical)

C	Si	Mn	Cu
0.08	0.10	0.50	<0.30 <sup>1</sup>

<sup>1</sup>:copper-plated

## Mechanical Properties

Submerged Arc Flux	AWS A5.17	Yield Strength (N/mm <sup>2</sup> )	Tensile Strength (N/mm <sup>2</sup> )	Elongation ((Lo=5do) (%))	Impact Strength ISO-V(J)		
					0°C	-20°C	-30°C
ELIFLUX BAR	F6 AZ-EL 12	360	460	26	47	---	---
ELIFLUX BFB	F6 A2-EL 12	380	480	28	---	55	47
ELIFLUX BMS	F6 AZ-EL 12	395	475	24	38	---	---
ELIFLUX BBR-AG	F6 A0-EL 12	370	480	30	60	50	---

## Chemical Composition of Weld Metal - % (Typical)

Submerged Arc Flux	C	Si	Mn
ELIFLUX BAR	0.07	0.50	1.10
ELIFLUX BFB	0.06	0.25	1.20
ELIFLUX BMS	0.05	0.80	1.10
ELIFLUX BBR-AG	0.06	0.30	0.90

## Typical Base Material Grades

- Structural Steels: S185-S235JR
- Pipe Steels: S275N
- Boiler Steels: P235GH
- Ship-Construction Steels : A, B, D
- Fine-grained Steels: P275N, S355N

## Features and Applications

- Copper-coated wire.
- Applicability in welding of steel constructions, pipes and tanks as well as in submerged arc welding of unalloyed structural steels and plates.

## Operating Data

Product Code	Diameter (mm) / (inch)		Weight (Kg)	Package Type
3010400000	1.6	1/16	25	K 435 *BIG PACK
3010400001	2.0	5/64	25	
3010400002	2.4	3/32	25	
3010400003	3.2	1/8	25	
3010400004	4.0	5/32	25	
3010400005	5.0	3/16	25	

\* Packaging alternatives according to the order; 30 - 350 - 550 - 1000 Kg

**Approvals:** S1 x ELIFLUX BAR · BV, DNV-GL, TL, ABS, LR, CE, SEPRO

S1 : TSE, CE GOST-R, SEPRO

### Standards

TS EN ISO 14171-A	: S2
EN ISO 14171-A	: S2
AWS A5.17	: EM 12

### Chemical Composition of Welding Wire % (Typical)

C	Si	Mn	Cu
0.12	0.10	1.0	<0.30 <sup>1</sup>

<sup>1</sup>:copper-plated

### Mechanical Properties

Submerged Arc Flux	AWS A5.17	Yield Strength (N/mm <sup>2</sup> )	Tensile Strength (N/mm <sup>2</sup> )	Elongation ((Lo=5do) (%))	Impact Strength ISO-V(J)			
					0°C	-20°C	-30°C	-40°C
ELIFLUX BAR	F6 AZ-EM 12 F6 PZ-EM 12	400	500	30	60	---	---	---
ELIFLUX BFB	F7 A4-EM 12	460	525	30	---	70	55	50
ELIFLUX BFF	F7 A4-EM 12	410	520	24	---	---	70	60
ELIFLUX BBR-AG	F7 A2 EM12	410	490	32	50	50	50	---
ELIFLUX BMS	F6 A0-EM 12	390	485	30	---	69	---	---
ELIFLUX PIPE	F7 A4-EM 12	460	550	26	---	75	---	50
ELIFLUX BAB-S	F7 A4-EM 12	430	525	29	---	---	---	60 J

### Chemical Composition of Weld Metal - % (Typical)

Submerged Arc Flux	C	Si	Mn
ELIFLUX BAR	0.07	0.60	1.35
ELIFLUX BFB	0.07	0.35	1.50
ELIFLUX BFF	0.05	0.20	1.00
ELIFLUX BBR-AG	0.10	0.35	1.20
ELIFLUX BMS	0.04	0.45	1.27
ELIFLUX PIPE	0.07	0.40	1.35

### Typical Base Material Grades

- Structural Steels: S355JR
- Pipe Steels : L360
- Boiler Steels: P295GH, P 355 GH
- Ship-Construction Steels: A, B, D, E
- Fine-grained steels : P355N, S355N

### Features and Applications

- Applicability in welding of steel construction, pipe manufacturing, pressure vessels, structural steels and ship plates, general structural steels with tensile strength up to 500 N/mm<sup>2</sup> and unalloyed or medium strength steel

### Operating Data

Product Code	Diameter (mm) / (inch)		Weight (Kg)	Package Type
3010400033	1.6	1/16	25	K 435 *BIG PACK
3010400034	2.0	5/64	25	
3010400035	2.4	3/32	25	
3010400036	3.2	1/8	25	
3010400037	4.0	5/32	25	
3010400038	5.0	3/16	25	

\* Packaging alternatives according to the order:  
30 - 350 - 550 - 1000 Kg

**Approvals:** S2: CE, GOST-R, TSE, DB, SEPPO • S2 x ELIFLUX BAR: BV, ABS, CE, DB  
S2 x ELIFLUX BAB-S : ABS, CE • S2 x ELIFLUX BFB: TL, DNV-GL, BV, ABS, LR, RS, NK, RINA, TÜV, CE, DB  
S2 x ELIFLUX BMS: BV, ABS, CE

## Standards

TS EN ISO 14171-A	: S2 Si
EN ISO 14171-A	: S2 Si
AWS A5.17	: EM 12 K

## Chemical Composition of Welding Wire % (Typical)

C	Si	Mn	Cu
0.10	0.25	1.0	<0.30 <sup>1</sup>

<sup>1</sup>:copper-plated

## Mechanical Properties

Submerged Arc Flux	AWS A5.17	Yield Strength (N/mm <sup>2</sup> )	Tensile Strength (N/mm <sup>2</sup> )	Elongation ((Lo=5do) (%))	Impact Strength ISO-V(J)		
					-20°C	-30°C	-40°C
ELIFLUX BFB	F7A2-EM12K	430	530	28	80	70	---
	F7P2-EM12K						
ELIFLUX BFF	F7A4-EM12K	450	540	23	---	---	65
	F7P4-EM12K						
ELIFLUX BAB-S	F7A4-EM12K	440	550	28	100	---	65
ELIFLUX BBR-AG	F7A0-EM12K	420	510	29	50	---	---

## Chemical Composition of Weld Metal - % (Typical)

Submerged Arc Flux	C	Si	Mn
ELIFLUX BFB	0.05	0.40	1.70
ELIFLUX BFF	0.06	0.30	1.10
ELIFLUX BAB-S	0.07	0.45	1.60
ELIFLUX BBR-AG	0.07	0.40	1.30

## Typical Base Material Grades

- Structural Steels: S355JR
- Pipe Steels : L360
- Boiler Steels: P295GH, P 355 GH
- Ship-Construction Steels : A, B, D, E

## Features and Applications

- Applicability in submerged arc welding of steel materials with medium or high levels of tensile strength
- Usability in manufacture processes of pressure vessels, boilers, pipes, ship and other steel construction purposes
- Decreased affinity to Oxygen due to high content of Silicon
- Increased electric conductivity, and increased resistance to corrosion due to copper coating

## Operating Data

Product Code	Diameter (mm) / (inch)		Weight (Kg)	Package Type
3010400071	2.0	5/64	25	K 435 *BIG PACK  <small>* Packaging alternatives according to the order; 30 - 350 - 550 - 1000 Kg</small>
3010400072	2.4	3/32	25	
3010400073	3.2	1/8	25	
3010400074	4.0	5/32	25	
3010400075	5.0	3/16	25	

**Approvals:** S2Si: TSE, CE, GOST-R, SEPPO • S2Si x ELIFLUX BFF: BV, ABS, CE  
S2Si x ELIFLUX BFB: ABS, LR, BV, CE, DB

### Standards

TS EN ISO 14171-A	: S2 Mo
EN ISO 14171-A	: S2 Mo
AWS A5.23	: EA2

### Chemical Composition of Welding Wire % (Typical)

C	Si	Mn	Mo	Cu
0.12	0.10	1.0	0.5	<0.30 <sup>1</sup>

<sup>1</sup>:copper-plated

### Mechanical Properties

Submerged Arc Flux	AWS A5.23	Yield Strength (N/mm <sup>2</sup> )	Tensile Strength (N/mm <sup>2</sup> )	Elongation ((Lo=5do) (%))	Impact Strength ISO-V(J)	
					-20°C	-40°C
ELIFLUX BFB	F8A4-EA2-A2	490	600	26	90	60
ELIFLUX BFF	F8A4-EA2-A2 F8P5-EA2-A2	480	570	27	---	70
ELIFLUX BAB-S	F8A4-EA2-A3	500	600	26	---	60
ELIFLUX PIPE	F7 A4-EA2-A4	510	640	25	---	60

### Chemical Composition of Weld Metal - % (Typical)

Submerged Arc Flux	C	Si	Mn	Mo
ELIFLUX BFB	0.06	0.40	1.40	0.50
ELIFLUX BFF	0.07	0.25	1.15	0.45
ELIFLUX BAB-S	0.07	0.55	1.70	0.50
ELIFLUX PIPE	0.06	0.40	1.40	0.50

### Typical Base Material Grades

- Pipe Steels: L485MB(X70)
- Boiler Steels: 16Mo3, P355 GH
- Fine-grained Steels: S460N, P460N

### Features and Applications

- Specific applicability in welding high-strength low-alloyed steels and creep-resisting steels
- Weld metal of 1/2 Mo-alloy with resistance to creep at high-temperature applications
- Serviceability at temperatures of values up to 500°C

### Operating Data

Product Code	Diameter (mm) / (inch)		Weight (Kg)	Package Type
3010400140	2.0	5/64	25	K 435 *BIG PACK  <small>* Packaging alternatives according to the order; 30 - 350 - 550 - 1000 Kg</small>
3010400141	2.4	3/32	25	
3010400142	3.2	1/8	25	
3010400143	4.0	5/32	25	
3010400144	5.0	3/16	25	

**Approvals:** S2Mo x ELIFLUX BFB: BV, ABS, CE • S2Mo: TSE, TÜV, CE , GOST-R, DB, SEPRO  
S2Mo x ELIFLUX BFF: DNV-GL, BV, ABS, CE, DB • S2Mo x ELIFLUX BAB-S: ABS, CE

### Standards

TS EN ISO 26304	: S Z
EN ISO 26304	: S Z
AWS A5.23	: EA2TiB

### Chemical Composition of Welding Wire % (Typical)

C	Si	Mn	Mo	B	Ti
0.08	0.15	1.10	0.55	0.015	0.15

### Mechanical Properties

Submerged Arc Flux	AWS A5.23	Yield Strength (N/mm <sup>2</sup> )	Tensile Strength (N/mm <sup>2</sup> )	Elongation ((Lo=5do) (%))	Impact Strength ISO-V(J)		
					0°C	-20°C	-30°C
ELIFLUX BFF	F8A0-EG-G	550	650	21	60	45	---
ELIFLUX BFB	F9A2-EG-G	580	660	28	---	---	60

### Chemical Composition of Weld Metal - % (Typical)

Submerged Arc Flux	C	Si	Mn	Mo	Ti
ELIFLUX BFF	0.06	0.65	1.85	0.50	0.06
ELIFLUX BFB	0.06	0.50	1.70	0.50	0.06

### Typical Base Material Grades

- Pipe steels: L485MB(X70)
- Boiler steels: 16Mo3
- Fine-grained steels: S460N, P460N

### Features and Applications

- Specific applicability in welding high-strength low-alloyed steels and creep-resisting steels
- Serviceability at temperatures of values up to 500°C

### Operating Data

Product Code	Diameter (mm) / (inch)		Weight (Kg)	Package Type
3010400236	2.4	3/32	25	K 435 *BIG PACK
3010400237	3.2	1/8	25	
3010400238	4.0	5/32	25	

\* Packaging alternatives according to the order; 30 - 350 - 550 - 1000 Kg

Approvals: S2 Mo TiB : CE, GOST-R, SEPRO



**Standards**

TS EN ISO 14171-A	: S3 Si
EN ISO 14171-A	: S3 Si
AWS A5.17	: EH 12 K

**Chemical Composition of Welding Wire % (Typical)**

C	Si	Mn	Cu
0.10	0.30	1.70 - 1.80	<0.30 <sup>1</sup>

<sup>1</sup>copper-plated

**Mechanical Properties**

Submerged Arc Flux	AWS A5.17	Yield Strength (N/mm <sup>2</sup> )	Tensile Strength (N/mm <sup>2</sup> )	Elongation ((L <sub>0</sub> =5d <sub>0</sub> ) (%))	Impact Strength ISO-V(J)	
					0°C	-40°C
ELIFLUX BFF	F7A4-EH 12K	490	580	26	100	70
ELIFLUX BFB	F7A4-EH 12K	460	550	27	---	60
ELIFLUX BAB-S	F7A4-EH 12K	545	645	26	---	60

**Chemical Composition of Weld Metal - % (Typical)**

Submerged Arc Flux	C	Si	Mn
ELIFLUX BFF	0.10	0.35	1.65
ELIFLUX BFB	0.07	0.40	1.80
ELIFLUX BAB-S	0.07	0.60	1.70

**Typical Base Material Grades**

- Fine-grained Steels: S460N, P460N

**Features and Applications**

- Inclusion of high contents of Mn-Si alloy
- Applicability in submerged arc welding processes of medium- and high-strength structural steels and of steels in offshore structures

**Operating Data**

Product Code	Diameter (mm) / (inch)		Weight (Kg)	Package Type
3010400110	2.0	5/64	25	K 435 *BIG PACK  <small>* Packaging alternatives according to the order; 30 - 350 - 550 - 1000 Kg</small>
3010400111	2.4	3/32	25	
3010400112	3.2	1/8	25	
3010400113	4.0	5/32	25	
3010400114	5.0	3/16	25	

**Approvals:** S3 Si x ELIFLUX BFF: BV, ABS, CE • S3 Si: CE, GOST-R, TSE, SEPRO • S3 Si x ELIFLUX BAB-S : ABS, CE

### Standards

TS EN ISO 14171-A	: S3 Mo
EN ISO 14171-A	: S3 Mo
AWS A5.23	: EA4

### Chemical Composition of Welding Wire % (Typical)

C	Si	Mn	Mo	Cu
0.10	0.15	1.50	0.50	<0.30 <sup>1</sup>

<sup>1</sup>:copper-plated

### Mechanical Properties

Submerged Arc Flux	AWSA5.23	Yield Strength (N/mm <sup>2</sup> )	Tensile Strength (N/mm <sup>2</sup> )	Elongation ((Lo=5do) (%)	Impact Strength ISO-V(J)	
					0°C	-40°C
ELIFLUX BFF	F8 A4-EA4-A4	540	630	27	110	65
ELIFLUX PIPE	F8 A4-EA4-A4	530	620	25	100	50

### Chemical Composition of Weld Metal - % ( Typical)

Submerged Arc Flux	C	Si	Mn	Mo
ELIFLUX BFF	0.07	0.50	1.75	0.50
ELIFLUX PIPE	0.06	0.40	1.60	0.45

### Typical Base Material Grades

- Fine-grained Steels : S460N, P460N

### Features and Applications

- Suitability to high-quality welding of Mo-alloyed steels, boiler sheet steels, and fine-grained steels

### Operating Data

Product Code	Diameter (mm) / (inch)		Weight (Kg)	Package Type
3010400176	2.4	3/32	25	K 435
3010400178	4.0	5/32	25	*BIG PACK

**Approvals:** S3 Mo: TSE, CE, GOST-R, SEPRO

\* Packaging alternatives according to the order; 30 - 350 - 550 - 1000 Kg

### Standards

TS EN ISO 26304-A	: S Z
EN ISO 26304-A	: S Z
AWS A5.23	: E-G

### Chemical Composition of Welding Wire % (Typical)

C	Si	Mn	Ti	B
0.08	0.25	1.40	0.14	0.011

### Mechanical Properties

Submerged Arc Flux	AWS A5.23	Yield Strength (N/mm <sup>2</sup> )	Tensile Strength (N/mm <sup>2</sup> )	Elongation ((Lo=5do) (%))	Impact Strength ISO-V(J)	
					0°C	-20°C
ELIFLUX PIPE	F8A0-EG-G	520	630	24	80	50

### Chemical Composition of Weld Metal - % (Typical)

Submerged Arc Flux	C	Si	Mn
ELIFLUX PIPE	0.06	0.50	1.30

### Typical Base Material Grades

- Pipe Steels: X52, X56, X60, X65, X70, X80, L360MB, L385M, L415MB, L450MB, L485MB, L555MB

### Features and Applications

- Used in submerged arc welding of pipe steels
- It is suitable to use for multi and two run technique and applications with high toughness requirements

### Operating Data

Product Code	Diameter (mm) / (inch)		Weight (Kg)	Package Type
3010400206	1.6	1/16	25	K 435 *DRUM
3010400207	2.0	5/64	25	
3010400208	2.4	3/32	25	
3010400209	3.2	1/8	25	
3010400210	4.0	5/32	25	
3010400211	5.0	3/16	25	

\* Packaging alternatives according to the order; 400 - 600 Kg

Approvals: S3 Mo: TSE, CE, GOST-R, SEPRO

### Standards

TS EN ISO 26304-A	: S Z
EN ISO 26304-A	: S Z
AWS A5.23	: E A 2 TiB (mod.)

### Chemical Composition of Welding Wire % (Typical)

C	Si	Mn	Mo	Ti	B
0.08	0.25	1.20	0.52	0.14	0.011

### Mechanical Properties

Submerged Arc Flux	AWS A5.23	Yield Strength (N/mm <sup>2</sup> )	Tensile Strength (N/mm <sup>2</sup> )	Elongation ((Lo=5do) (%))	Impact Strength ISO-V(J)	
					20°C	-20°C
ELIFLUX PIPE	F8A0-EA2TiB (mod.)-G	545	680	26	100	60

### Chemical Composition of Weld Metal - % (Typical)

Submerged Arc Flux	C	Si	Mn	Mo
ELIFLUX PIPE	0.06	0.60	1.50	0.40

### Typical Base Material Grades

- Pipe Steels: X52, X56, X60, X65, X70, X80, L360MB, L385M, L415MB, L450MB, L485MB, L555MB

### Features and Applications

- Wire for submerged arc welding of pipeline steels
- Optimized for multi-arc welding using two-run technique
- For applications with high toughness requirements

### Operating Data

Product Code	Diameter (mm) / (inch)		Weight (Kg)	Package Type
3010400255	2.4	3/32	25	K 435 *BIG PACK
3010400256	3.2	1/8	25	
3010400257	4.0	5/32	25	

Approvals: GOST-R, CE, SEPRO

\* Packaging alternatives according to the order; 30 - 350 - 550 - 1000 Kg

### Standards

TS EN ISO 26304-A	: S3 Ni1Mo
EN ISO 26304-A	: S3 Ni1Mo
AWS A5.23	: EF3

### Chemical Composition of Welding Wire % (Typical)

C	Si	Mn	Mo	Ni
0.12	0.20	1.75	0.55	0.90

### Mechanical Properties

Submerged Arc Flux	AWS A5.23	Yield Strength (N/mm <sup>2</sup> )	Tensile Strength (N/mm <sup>2</sup> )	Elongation ((L <sub>0</sub> =5d <sub>0</sub> ) (%))	Impact Strength ISO-V(J)	
					-20°C	-40°C
ELIFLUX BFF	F9 A4-EF3-F3	580	650	21	100	60

### Chemical Composition of Weld Metal - % (Typical)

Submerged Arc Flux	C	Si	Mn	Mo	Ni
ELIFLUX BFF	0.09	0.25	1.65	0.55	0.90

### Typical Base Material Grades

- Pipe Steels : X52, X56, X60, X65, X70, X80, L360MB, L385M, L415MB, L450MB, L485MB, L555MB
- Fine-grained Steels: S550QL1 S380N, S500N, S380NL, S500NL
- Pressure Steels: 20 MnMoNi5-5

### Features and Applications

- S3NiMo1 is a Nickel-Molybdenum-Alloyed, copper-coated wire designed for submerged arc welding of structural steels and higher tensile steels

### Operating Data

Product Code	Diameter (mm) / (inch)		Weight (Kg)	Package Type
3010400273	2.4	3/32	25	K 435 *BIG PACK
3010400274	3.2	1/8	25	
3010400275	4.0	5/32	25	

\* Packaging alternatives according to the order; 30 - 350 - 550 - 1000 Kg

### Standards

TS EN ISO 26304-A	: S 3 Ni2.5CrMo
EN ISO 26304-A	: S 3 Ni2.5CrMo
AWS A5.23	: EM4 (mod.)

### Chemical Composition of Welding Wire % (Typical)

C	Si	Mn	Mo	Ni	Cr
0.11	0.17	1.40	0.55	2.40	0.70

### Mechanical Properties

Submerged Arc Flux	AWS A5.23	Yield Strength (N/mm <sup>2</sup> )	Tensile Strength (N/mm <sup>2</sup> )	Elongation ((Lo=5do) (%))	Impact Strength ISO-V(J)		
					-20°C	-40°C	-60°C
ELIFLUX BFF	F11A8-EM4 (mod.)-M4	740	850	20	90	85	min.27
ELIFLUX BAB-S	F11A4-EM4(mod.)-M4	735	855	18	70	60	---

### Chemical Composition of Weld Metal - % (Typical)

Submerged Arc Flux	C	Si	Mn	Mo	Ni	Cr
ELIFLUX BFF	0.06	0.30	1.50	0.50	2.20	0.50
ELIFLUX BAB-S	0.05	0.65	1.80	0.48	2.05	0.35

### Typical Base Material Grades

- Fine-grained steels: S550QL1, S690QL1

### Features and Applications

- S3NiCrMo 2.5 is a CrNiMo alloyed, Copper-coated wire designed for submerged arc welding of high strength quenched, tempered structural steels and extra high tensile steels

### Operating Data

Product Code	Diameter (mm) / (inch)		Weight (Kg)	Package Type
3010400291	2.4	3/32	25	K 435 *DRUM <small>* Packaging alternatives according to the order; 400 - 600 Kg</small>
3010400292	3.2	1/8	25	
3010400293	4.0	5/32	25	

**Approvals:** S3NiCrMo2.5 : GOST-R, CE, SEPRO

**Mechanical Properties**

Submerged Arc Welding Wire	Submerged Arc Welding Wire Flux	Standards (AWS A5.9)	Tensile Strength (N/mm <sup>2</sup> )	Elongation ((Lo=5do) (%))	Impact Strength ISO-V(J)		
					0°C	-110°C	-196°C
ELOX UP 307	ELIFLUX BSS-A	ER 307	620	---	---	37	---
ELOX UP 308L	ELIFLUX BSS-A	ER 308L	555	42	72	48	41
ELOX UP 309L	ELIFLUX BSS-A	ER 309L	545	36	---	---	---
ELOX UP 316L	ELIFLUX BSS-A	ER 316L	570	39	63	52	40
ELOX UP 2209	ELIFLUX BSS-D	ER 2209	830	32	---	---	---
ELOX UP 410	ELIFLUX BSS-F	ER 410	530	25	---	---	---
ELOX UP 430	ELIFLUX BSS-F	ER 430	460	20	---	---	---

**Chemical Composition of Weld Metal - % (Typical)**

Product	Submerged Arc Welding Wire Flux	C	Si	Mn	Mo	Cr	Ni	P	S
ELOX UP 308L	ELIFLUX BSS-A	0.030	0.53	1.55	---	19.25	9.36	0.015	0.008
ELOX UP 309L	ELIFLUX BSS-A	0.028	0.42	1.65	0.55	24.25	13.16	0.014	0.009
ELOX UP 316L	ELIFLUX BSS-A	0.030	0.40	1.75	2.15	19.10	11.30	0.018	0.010
ELOX UP 2209	ELIFLUX BSS-D	0.030	0.90	1.85	3.15	21.85	8.50	0.018	0.008
ELOX UP 410	ELIFLUX BSS-F	0.110	0.31	0.39	0.13	13.20	0.37	0.028	0.010
ELOX UP 430	ELIFLUX BSS-F	0.040	0.40	0.50	0.20	16.50	0.18	0.020	0.010

**Package Type**

Product	Diameter (mm) / (inch)	Diameter (mm)	Weight (Kg)
ELOX UP 307	6011100384	2.4	25
ELOX UP 308L	6011100299	2.4	25
	6011100091	3.2	25
ELOX UP 309L	6011100300	2.4	25
	6011100301	3.2	25
	6011100302	4.0	25
ELOX UP 316L	6011100303	2.4	25
	6011100096	3.2	25
ELOX UP 2209	6011100306	2.4	25
	6011100307	3.2	25
ELOX UP 410	6011100304	4.0	25
ELOX UP 430	6011100098	3.2	25
	6011100305	4.0	25

**Approvals:** GOST-R, CE, SEPRO  
 GeKa ELOX UP 2209 x ELIFLUX BSS-D : CE, NK

### Standards

TS EN ISO 14174	: SA AR 1 77 AC
EN ISO 14174	: SA AR 1 77 AC
AWS A5.17	: F6AZ-EL12 / F7AZ-EM12

Basicity 0.7
-----------------

### Mechanical Properties

SAW Wire	AWS A5.17	Yield Strength (N/mm <sup>2</sup> )	Tensile Strength (N/mm <sup>2</sup> )	Elongation ((Lo=5do) (%))	Impact Strength ISO-V(J)
					0°C
S1	F6AZ-EL 12	360	460	26	47
S2	F7AZ-EM 12	400	500	30	60

### Chemical Composition of Weld Metal - % (Typical)

SAW Wire	C	Si	Mn
S1	0.07	0.50	1.10
S2	0.07	0.60	1.35

### Features and Applications

- A type of SAW rutile flux structured from agglomerated aluminate
- Applicability in single-pass joint welding and fillet welding of particularly spiral welded pipes, LPG cylinders, general-purpose construction steels, boiler sheet, and shipbuilding steels
- Low consumption of flux. Basicity : 0.7
- Straight and nonporous welding beads
- Formation of very easily-removed slag
- Requirement of re-drying at 250-350°C for 2 hours

### Operating Data

Product Code	Package Weight (Kg)	Package Type
3010800006	25	Kraft Bag

**Approvals:** S1 x ELIFLUX BAR: BV, DNV-GL, TL, ABS, LR, CE • S2 x ELIFLUX BAR: BV, ABS, CE, DB  
 ELIFLUX BAR: GOST-R , CE, SEPRO



### Standards

TS EN ISO 14174	: SA AB 1 67 AC
EN ISO 14174	: SA AB 1 67 AC
AWS A5.17	: F7 A5-EM12 / F7A5-EM12K

Basicity 1.60
------------------

### Mechanical Properties

SAW Wire	AWS A5.17	Yield Strength (N/mm <sup>2</sup> )	Tensile Strength (N/mm <sup>2</sup> )	Elongation ((L <sub>0</sub> =d <sub>0</sub> ) (%))	Impact Strength ISO-V(J)		
					0°C	-40°C	-45°C
S2	F7A5-EM 12	430	520	30	110	75	min.47
S2Si	F7A5-EM 12K	465	570	30	100	85	min.47

### Chemical Composition of Weld Metal - % (Typical)

SAW Wire	C	Si	Mn
S2	0.05	0.30	1.40
S2 Si	0.06	0.40	1.40

### Features and Applications

- SAW flux type composed of agglomerated aluminate-basic.
- Basicity: 1.6 (According to Boniszewski formula).
- Applicability in single and multi-pass welding of general-purpose construction steels.
- Formation of easily-removed slag.
- Requirement of re-drying at 300 - 350°C for 2 hours.

### Operating Data

Product Code	Package Weight (Kg)	Package Type
3010800035	25	Kraft Bag

## Standards

TS EN ISO 14174	: SA AB 1 67 AC H5
EN ISO 14174	: SA AB 1 67 AC H5
AWS A5.17	: F6AZ-EL12 / F7A0-EM12 F7A0-EM12K

Basicity
1.1

## Mechanical Properties

SAW Wire	AWS A5.17	Yield Strength (N/mm <sup>2</sup> )	Tensile Strength (N/mm <sup>2</sup> )	Elongation ((Lo=5do) (%))	Impact Strength ISO-V(J)	
					0°C	-20°C
S1	F6AZ-EL12	370	480	30	55	---
S2	F7A0-EM12	410	490	32	---	50
S2Si	F7A0-EM12K	420	510	29	---	50

## Chemical Composition of Weld Metal - % (Typical)

SAW Wire	C	Si	Mn
S1	0.06	0.30	0.90
S2	0.10	0.35	1.20
S2Si	0.07	0.40	1.30

## Features and Applications

- Agglomerated aluminate-basic type welding flux.
- Especially suitable for singlepass joining and fillet welding of LPG cylinders, welded spiral pipes (with S2 combination up to X52 pipe), general constructions, steels, boiler plates and ship plates.
- The weld bead looks more like a rutile type weld bead.
- Easy removable slag.
- Before using : The welding flux should be dried 2h between 300°C - 350°C.

## Operating Data

Product Code	Package Weight (Kg)	Package Type
3010800026	25	Kraft Bag

Approvals: CE, GOST-R, SEPRO

### Standards

TS EN ISO 14174	: SA AB 1 68 AC H5
EN ISO 14174	: SA AB 1 68 AC H5
AWS A5.17	: F6A2-EL12 / F7A4-EM12 / F7A2-EM12K / F7A4-EH12K
AWS A5.23	: F8A4-EA2-A2

Basicity 1.4
-----------------

### Mechanical Properties

SAW Wire	AWS A5.17 / AWS A5.23	Yield Strength (N/mm <sup>2</sup> )	Tensile Strength (N/mm <sup>2</sup> )	Elongation ((Lo=5do) (%))	Impact Strength ISO-V(J)		
					-20°C	-30°C	-40°C
S1	F6A2-EL12	380	480	28	55	47	---
S2	F7A4-EM 12	460	525	30	70	55	50
S2 Si	F7A2-EM12K	430	530	28	80	70	---
S3 Si	F7A4-EH12K	460	550	27	---	---	60
S2 Mo	F8A4-EA2-A2	490	600	26	90	---	60

### Chemical Composition of Weld Metal - % (Typical)

SAW Wire	C	Si	Mn	Mo
S1	0.06	0.25	1.20	---
S2	0.07	0.35	1.50	---
S2 Si	0.05	0.40	1.70	---
S3 Si	0.07	0.40	1.80	---
S2 Mo	0.06	0.40	1.40	0.50

### Features and Applications

- A type of submerged welding (SAW) basic flux structured from agglomerated aluminate.
- Applicability in single-and multi-pass (butt-) joint welding and fillet welding of general-purpose construction steels, shipbuilding steel, boiler sheet, heat-resisting steels, and fine-grained steels.
- Low consumption of flux.
- Basicity: 1.4
- High toughness of weld metal at low temperatures.
- Formation of easily-removed slag.
- Requirement of re-drying at 300°C - 350°C for 2 hours.

### Operating Data

Product Code	Package Weight (Kg)	Package Type
301080002	25	Kraft Bag

**Approvals:** ELIFLUX BFB: CE, GOST-R, SEPRO • S2Si x ELIFLUX BFB: ABS, LR, CE

S2 x ELIFLUX BFB: TL, DNV-GL, BV, ABS, LR, RS, NK, RINA, DB • S2Mo x ELIFLUX BFB: BV, ABS, CE

## Standards

TS EN ISO 14174	: SA AB 1 78 AC H5
EN ISO 14174	: SA AB 1 78AC H5
AWS A5.17	: F7A4-EM12
AWSA5.23	: F7A4-EA2-A2 / F8A4-EA4-A4

Basicity 1.7
-----------------

## Mechanical Properties

SAW Wire	AWS A5.17/ AWS A5.23	Yield Strength (N/mm <sup>2</sup> )	Tensile Strength (N/mm <sup>2</sup> )	Elongation ((Lo=5do) (%))	Impact Strength ISO-V(J)		
					0°C	-20°C	-40°C
S2	F7A4-EM 12	460	550	26	---	75	50
S2 Mo	F7A4 EA2-A2	510	640	25	---	---	60
S3 Mo	F8A4-EA4-A4	530	620	25	100	---	50

## Chemical Composition of Weld Metal - % ( Typical)

SAW Wire	C	Si	Mn	Mo
S2	0.05	0.40	1.35	---
S2 Mo	0.06	0.40	1.40	0.50
S3 Mo	0.06	0.40	1.60	0.45

## Features and Applications

- SAW flux type composed of agglomerated aluminate Basic.
- Basicity of the flux According to Boniszewski Formula is 1.7
- Excellent removal of slags of weld beads formed at high temperatures
- Suitability for use in both bilateral and tandem (AC/DC) welding operations.
- Sufficiently high toughness of weld metals obtained particularly by 2-pass welding operations.
- Suitability for use in welding of high-strength steels.
- Process requirement of re-drying at 300°C - 350°C for 2 hours.

## Operating Data

Product Code	Package Weight (Kg)	Package Type
3010800019	25	Kraft Bag

Approvals: CE, GOST-R , SEPRO

### Standards

TS EN ISO 14174	: SA AB 1 68 AC H5
EN ISO 14174	: SA AB 1 68 AC H5
AWS A5.17	: F7A4-EH12K/ F7A4-EM12 F7A4-EM12K
AWS A5.23	: F8A4-EA2-A3 / F11A4-EM4(mod)-M4

Basicity
2.1

### Mechanical Properties

SAW Wire	AWS A5.17 AWS A5.23	Yield Strength (N/mm <sup>2</sup> )	Tensile Strength (N/mm <sup>2</sup> )	Elongation ((Lo=5do) (%))	Impact Strength ISO-V(J)		
					-20°C	-30°C	-40°C
S2	F7A4-EM12	430	525	29	---	---	60
S2Si	F7A4-EM12K	440	550	28	100	---	65
S2 Mo	F8A4-EA2-A3	500	600	26	---	---	60
S3Si	F7A4-EH12K	545	645	26	---	---	60
S3NiCrMo2.5	F11A4-EM4(mod)-M4	735	855	18	---	70	60

### Chemical Composition of Weld Metal - % (Typical)

Saw Wire	C	Si	Mn	Mo	Ni	Cr
S2	0.08	0.40	1.50	---	---	---
S2 Si	0.07	0.45	1.60	---	---	---
S2 Mo	0.07	0.55	1.70	0.50	---	---
S3 Si	0.07	0.60	1.70	---	---	---
S3 NiCrMo 2.5	0.05	0.65	1.80	0.48	2.05	0.35

### Features and Applications

- SAW Flux type is composed of agglomerated Aluminate Basic.
- Weld beads of excellent surface appearance.
- Slag can be removed easily.
- This product has high current carrying capacity.
- GeKa ELIFLUX BAB-S is suitable for multipass and tandem welding especially for manufacturing of spiral pipe.
- It has suitable of high working speed.
- Suitable for the use of welding of high strength steels.
- Process requirement of re-drying at 300°C - 350°C for 2 hours.

### Operating Data

Product Code	Package Weight (Kg)	Package Type
3010800022	25	Kraft Bag

**Approvals:** ELIFLUX BAB-S: CE, GOST-R, SEPRO • S2 x ELIFLUX BAB-S: ABS • S3Si x ELIFLUX BAB-S: ABS  
 S2Mo x ELIFLUX BAB-S: ABS • S3NiCrMo2.5 x ELIFLUX BAB-S: ABS,

### Standards

TS EN ISO 14174	: SA AB 1 66 AC H5
EN ISO 14174	: SA AB 1 66 AC H5
AWS A5.17	: F7A2-EM12/F7A2-EM12K
AWS A5.23	: F8A4-EA2-A2

Basicity
1.6

### Mechanical Properties

SAW Wire	AWSA5.17 AWSA5.23	Yield Strength (N/mm <sup>2</sup> )	Tensile Strength (N/mm <sup>2</sup> )	Elongation (Lo=5do) (%)	Impact Strength ISO-V(J)	
					-30°C	-40°C
S2	F7A2-EM 12	430	520	29	60	---
S2 Si	F7A2 EM12K	440	515	30	65	---
S2 Mo	F8A4-EA2-A2	490	595	26	---	60

### Chemical Composition of Weld Metal - % (Typical)

SAW Wire	C	Si	Mn	Mo
S2	0.06	0.35	1.20	---
S2Si	0.07	0.40	1.25	---
S2 Mo	0.07	0.40	1.30	0.50

### Features and Applications

- GeKa ELIFLUX BFPP, is agglomerated aluminate basic flux for submerged arc welding
- It features high impact toughness and low hydrogen content
- It is suitable for double wire welding and narrow gap welding of thick steel plates and spiral welded pipes
- With suitable wires, also can be used for welding of pressure vessels
- Flux should be re-dried before use for 2 hours at 300°C - 350°C

### Operating Data

Product Code	Package Weight (Kg)	Package Type
6010800015	25	Kraft Bag

Approvals: SEPRO, GOST-R

### Standards

TS EN ISO 14174	: SA FB 1 66 AC H5
EN ISO 14174	: SA FB 1 66 AC H5
AWS A5.17	: F7A2-EM12/F7A2-EM12K
AWS A5.23	: F8A4-EA2-A2/F8A5-EA4-A3/ F11A8-EM4(mod)-M4

Basicity
2.8

### Mechanical Properties

SAW Wire	AWS A5.17 AWS A5.23	Yield Strength (N/mm <sup>2</sup> )	Tensile Strength (N/mm <sup>2</sup> )	Elongation (Lo=5do) (%)	Impact Strength ISO-V(J)			
					-30°C	-40°C	-50°C	-60°C
S2	F7A2-EM12	430	520	29	60	---	---	---
S2 Si	F7A2-EM12K	440	515	30	65	---	---	---
S2 Mo	F8A4-EA2-A2	490	595	26	---	60	---	---
S3Si	F8A5-EA4-A3	500	588	27	---	100	80	---
S3NiCrMo2.5	F11A8-EM4(mod)-M4	700	775	23	---	55	45	min.27

### Chemical Composition of Weld Metal - % (Typical)

Saw Wire	C	Si	Mn	Mo	Cr	Ni
S2	0.06	0.35	1.20	---	---	---
S2 Si	0.07	0.40	1.25	---	---	---
S2 Mo	0.07	0.40	1.30	0.50	---	---
S3 Mo	0.05	0.30	1.75	0.50	---	---
S3 NiCrMo 2.5	0.06	0.40	1.75	0.50	0.40	2.10

### Features and Applications

- GeKa ELIFLUX BFPV, high basic, is agglomerated fluoride basic flux for submerged arc welding.
- It features high impact toughness and low hydrogen content
- It is suitable for double wire welding and narrow gap welding of thick steel plates, pressure vessels
- Flux should be re-dried before use for 2 hours at 300°C - 350°C

### Operating Data

Product Code	Package Weight (Kg)	Package Type
6010800016	25	Kraft Bag

Approvals: SEPRO, GOST-R

### Standards

TS EN ISO 14174	: SA FB 1 65 DC H5
EN ISO14174	: SA FB 1 65 DC H5
AWS A5.17	: F7A4-EM12/F7A4-EM12K/ F7A4-EH12K
AWS A5.23	: F8A4-EA2-A2/ F9A4-EF3(mod)-F3 / F11A8-EM4(mod)-M4

Basicity 3.0
-----------------

### Mechanical Properties

SAW Wire	AWS A5.17 AWS A5.23	Yield Strength (N/mm <sup>2</sup> )	Tensile Strength (N/mm <sup>2</sup> )	Elongation ((Lo=5do) (%))	Impact Strength ISO-V(J)			
					-20°C	-30°C	-40°C	-60°C
S2	F7A4-EM12	410	520	24	---	70	60	---
S2 Si	F7A4-EM12K	450	540	23	---	---	65	---
S2 Mo	F8A4-EA2-A2	480	570	27	---	---	70	---
S3 Si	F7A4-EH12K	490	580	26	---	---	60	---
S3 NiMo1	F9A4-EF3(mod)-F3	580	650	21	100	---	60	---
S3NiCrMo2.5	F11A8-EM4(mod.)-M4	740	850	20	90	---	85	min.27

### Chemical Composition of Weld Metal - % (Typical)

Saw Wire	C	Si	Mn	Mo	Ni	Cr
S2	0.05	0.20	1.00	---	---	---
S2 Si	0.06	0.30	1.10	---	---	---
S2 Mo	0.07	0.25	1.15	0.45	---	---
S3 Si	0.10	0.60	1.70	---	---	---
S3 NiMo 1	0.09	0.25	1.65	0.55	0.90	---
S3 NiCrMo 2.5	0.06	0.30	1.50	0.50	2.20	0.50

### Features and Applications

- This is fluoride-basic agglomerated flux
- This flux is suitable for welding high strength low alloy steels
- Prefable to use with wire electrodes having higher manganese level
- Recommended for multi-pass welding, in particular when there are high toughness requirement
- Process requirement of re-drying at 300°C - 350°C for 2 hours

### Operating Data

Product Code	Package Weight (Kg)	Package Type
3010800012	25	Kraft Bag

**Approvals:** ELIFLUX BFF: CE, GOST-R, SEPPO • S2Si x ELIFLUX BFF: BV, ABS, CE  
 S3Si x ELIFLUX BFF: BV, ABS, CE • S2Mo x ELIFLUX BFF: DNV-GL, BV, ABS, CE  
 S3NiCrMo2.5 x ELIFLUX BFF: ABS, CE



### Standards

TS EN ISO 14174	: SA CS/MS 1 68 AC
EN ISO14174	: SA CS/MS 1 68 AC
AWS A5.17	: F6A0-EM12 / F6AZ-EL12

Basicity
1.0

### Mechanical Properties

SAW Wire	AWSA5.17	Yield Strength (N/mm <sup>2</sup> )	Tensile Strength (N/mm <sup>2</sup> )	Elongation ((Lo=5do) (%))	Impact Strength ISO-V(J)	
					0°C	-20°C
S1	F6AZ-EL12	395	475	24	38	---
S2	F6A0-EM12	390	485	30	---	69

### Chemical Composition of Weld Metal - % (Typical)

SAW Wire	C	Si	Mn
S1	0.05	0.80	1.10
S2	0.04	0.45	1.27

### Features and Applications

- A type of SAW flux structured from agglomerated manganese silicate and calcium silicate
- Basicity of the flux according to Boniszewski formula is 1,0
- Weld beads of excellent surface appearance and with easily removed slags
- High resistance to porosity caused by oil and rust
- High capacity of current flow
- Suitability for use in 2-pass welding operations on thick materials (best choice for base metals in thicknesses of 10-40 mm)
- Requirement of re-drying at 250-350°C for 2 hours

### Operating Data

Product Code	Package Weight (Kg)	Package Type
3010800009	25	Kraft Bag

Approvals: S2 / ELIFLUX BMS: BV, ABS, CE, SEPRO

ELIFLUX BMS: GOST-R, CE, SEPRO

## Standards

TS EN ISO 14174	: SA FB 2 65 DC
EN ISO 14174	: SA FB 2 65 DC

Basicity
2.45

## Mechanical Properties

SAW Wire	Standards	Tensile Strength (N/mm <sup>2</sup> )	Elongation ((Lo=5do) (%))	Impact Strength ISO-V(J)		
				0°C	-110°C	-196°C
ELOX UP 307	AWS A5.9 : ER 307	620	32	---	37	---
ELOX UP 308L	AWS A5.9 : ER 308 L	550	41	70	50	40
ELOX UP 309L	AWSA5.9: ER 309 L	540	35	---	---	---
ELOX UP 316 L	AWS A5.9: ER 316 L	570	39	60	50	40

## Chemical Composition of Weld Metal - % (Typical)

Saw Wire	C	Si	Mn	Mo	Cr	Ni
ELOX UP 307	0.08	0.90	6.50	---	19.00	9.00
ELOX UP 308 L	0.03	0.54	1.57	---	19.20	9.30
ELOX UP 309 L	0.03	0.40	1.63	0.03	24.20	13.10
ELOX UP 316 L	0.03	0.40	1.73	2.13	19.00	11.20

## Features and Applications

- A type of fluoride basic flux for SAW
- General use in submerged welding of stainless steel materials
- Very high corrosion resistance
- Very good mechanical properties
- Formation of easily-removable slags
- Requirement of re-drying at 300-350°C for 2 hours

## Operating Data

Product Code	Package Weight (Kg)	Package Type
6010800014	25	Kraft Bag

**Approvals:** GOST-R, CE, SEPRO

### Standards

TS EN ISO 14174	: SA FB 2 65 DC
EN ISO 14174	: SA FB 2 65 DC

Basicity
2.45

### Mechanical Properties

SAW Wire	AWS A5.9	Tensile Strength (N/mm <sup>2</sup> )	Elongation (Lo=5do) (%)
ELOX UP 2209	ER 2209	830	32

### Chemical Composition of Weld Metal - % ( Typical)

Saw Wire	C	Si	Mn	Mo	Cr	Ni
ELOX UP 2209	0.03	0.90	1.85	3.15	21.15	8.50

### Features and Applications

- A type of fluoride basic flux for SAW. General use in submerged welding of stainless steel materials
- The corrosion resistance and mechanical properties are good
- Formation of easily-removable slags
- Requirement of re-drying at 250°C - 350°C for 2 hours

### Operating Data

Product Code	Package Weight (Kg)	Package Type
601080007	25	Kraft Bag

**Approvals:** GeKa ELIFLUX BSS-D; CE, GOST-R, SEPRO  
 GeKa ELOX UP 2209 x ELIFLUX BSS-D; CE, CLASS NK

### Standards

TS EN ISO 14174	: SA FB 2 SA FB 3
EN ISO 14174	: SA FB 2 SA FB 3

Basicity
2.50

### Mechanical Properties

SAW Wire	Standards	Tensile Strength (N/mm <sup>2</sup> )	Elongation (Lo=5do) (%)
ELOX UP 410	AWS A5.9 : ER 410	530	25
ELOX UP 430	AWS A5.9 : ER 430	460	20

SAW Wire	Standards	Hardness (HB)	
		Single Pass	Three Pass
SUBCOR 41 NiMo - LH	AWS A5.22 : ~ EC 410 NiMo	350	400
SUBCOR 41 NiMo - MH	AWS A5.22 : ~ EC 410 NiMo	400	450
SUBCOR 430	AWS A5.9 : ER 430	---	200

### Chemical Composition of Weld Metal - % (Typical)

Saw Wire	C	Si	Mn	Mo	Cr	Ni
ELOX UP 410	0.09	0.31	0.35	---	13.30	0.37
ELOX UP 430	0.04	0.40	0.50	0.20	16.50	0.18
SUBCOR 41 NiMo-LH	0.07	0.35	1.50	1.00	12.50	2.20
SUBCOR 41 NiMo-MH	0.13	1.00	2.00	1.00	12.50	2.50
SUBCOR 430	0.05	0.70	2.00	---	17.00	---

### Features and Applications

- Non-alloyed, fluoride - basic agglomerated flux
- Used in hardfacing cladding for ferritic stainless steel with SUBCOR 430, SUBCOR 41 NiMo-LH, SUBCOR 41 NiMo-MH. Also suitable for joint welding
- All the properties of the wire is transferred to weld pool. Hardness will very depending on it
- Suitable for overlay welding with oscillation and single/multi-pass welding
- Formation of easily removable slag
- Re-drying at 300°C - 350°C/2h

### Operating Data

Product Code	Package Weight (Kg)	Package Type
3010800015	25	Kraft Bag

Approvals: CE, GOST-R, SEPRO

### Standards

TS EN ISO 14174	: SA FB 2 C Cr H5
EN ISO 14174	: SA FB 2 C Cr H5

### Mechanical Properties

SAW Wire	Hardness (HB)
S1	300

\* It is recommended to contact the manufacturer regarding the application.

### Chemical Composition of Weld Metal - % (Typical)

SAW - Wire	C	Si	Mn	Cr	Fe
S1	0.10-0.30	0.50-1.00	1.00-1.80	1.60-3.00	Rest

### Features and Applications

- A type of SAW flux structured from agglomerated calcium silicate
- This submerged arc welding powder and wire specification is used for hardfacing of steels
- Requirement of re-drying at 250°C - 350°C for 2 hours

### Operating Data

Product Code	Package Weight (Kg)	Packaging
6010800012	25	Kraft Bag

**Approvals:** ELIFLUX 350 : GOST-R, CE, SEPRO

**Standards**

TS 3623 EN 12536	: O I
EN 12536	: O I
AWS A5.2	: R 45

**Chemical Composition of Welding Wire % (Typical)**

C	Si	Mn
0.07	0.1	0.5

**Mechanical Properties**

Yield Strength (N/mm <sup>2</sup> )	Tensile Strength (N/mm <sup>2</sup> )	Impact Strength (ISO-V/+20°C)	Elongation ((L <sub>0</sub> =5d <sub>0</sub> ) (%))
min. 245	340 - 440	min. 35 J	min. 14

**Features and Applications**

- Oxy-acetylene / gas welding rod to be used for flame welding of all types of machinery parts made of unalloyed steels
- Body, exhaust, thin sheet pipe welding
- Neutral flame should be used

**Welding Positions**

**Flame Adjustment**

Neutral Flame

**Operating Data**

Product Code	Diameter x Length (mm) / (inch)		Weight (Kg)	Package Type
3010300000	1.60 x 1000	1/16 x 39"	5	Carton Box
3010300001	2.00 x 1000	5/64 x 39"	5	
3010300002	2.40 x 1000	3/32 x 39"	5	
3010300003	3.20 x 1000	1/8 x 39"	5	
3010300004	4.00 x 1000	5/32 x 39"	5	
3010300005	5.00 x 1000	3/16 x 39"	5	

**Approvals:** CE, GOST-R, SEPRO

**Standards**

TS 3623 EN 12536	: O Z
EN 12536	: O Z
AWS A5.2	: R 60

**Chemical Composition of  
Welding Wire % (Typical)**

C	Si	Mn
0.07	0.15	1.0

**Mechanical Properties**

Yield Strength (N/mm <sup>2</sup> )	Tensile Strength (N/mm <sup>2</sup> )	Impact Strength (ISO-V/+20°C)	Elongation ((L <sub>0</sub> =5d <sub>0</sub> ) (%))
min. 295	440 - 540	min. 39 J	min. 22

**Features and Applications**

- High quality welding of unalloyed or Mo-alloyed steels used in the production of boilers, pipe lines and constructions
- Mo-alloyed oxy-acetylene / gas welding with flame welding technique
- Excellent yield and welding properties
- Ideal welding rod for plumbers
- Neutral flame should be used

**Welding Positions**

**Flame Adjustment**

Neutral Flame

**Operating Data**

Product Code	Diameter x Length (mm) / (inch)		Weight (Kg)	Package Type
3010300040	1.60 x 1000	1/16 x 39"	5	Carton Box
3010300041	2.00 x 1000	5/64 x 39"	5	
3010300042	2.40 x 1000	3/32 x 39"	5	
3010300043	3.20 x 1000	1/8 x 39"	5	
3010300044	4.00 x 1000	5/32 x 39"	5	
3010300045	5.00 x 1000	3/16 x 39"	5	

**Approvals:** CE, GOST-R, SEPRO

**Standards**

TS 3623 EN 12536	: O IV
EN 12536	: O IV
AWS A5.2	: R 60-G

**Chemical Composition of Welding Wire % (Typical)**

C	Si	Mo	Mn
0.07	0.15	0.5	1.0

**Mechanical Properties**

Yield Strength (N/mm <sup>2</sup> )	Tensile Strength (N/mm <sup>2</sup> )	Impact Strength (ISO-V/+20°C)	Elongation ((L <sub>0</sub> =5d <sub>0</sub> ) (%))
min. 295	440 - 540	min. 39 J	min. 22

**Features and Applications**

- High quality welding of unalloyed or Mo-alloyed steels used in the production of boilers, pipe lines and constructions
- Mo-alloyed oxy-acetylene / gas welding with flame welding technique
- Excellent yield and welding properties
- Ideal welding rod for plumbers
- Neutral flame should be used

**Welding Positions**

**Flame Adjustment**

Neutral Flame

**Operating Data**

Product Code	Diameter x Length (mm) / (inch)		Weight (Kg)	Package Type
3010300078	1.60 x 1000	1/16 x 39"	5	Carton Box
3010300079	2.00 x 1000	5/64 x 39"	5	
3010300080	2.40 x 1000	3/32 x 39"	5	
3010300081	3.20 x 1000	1/8 x 39"	5	
3010300082	4.00 x 1000	5/32 x 39"	5	
3010300083	5.00 x 1000	3/16 x 39"	5	

**Approvals:** CE, GOST-R, SEPRO



# SPECIAL WELDING PRODUCTS



### Features and Applications

- Gouging and removal of old, worn or cracked parts and correction of casting defects
- Cleaning defective surfaces and removing faulty welding deposits
- Gouging and chamfering all industry metals
- Easy striking and restriking, high gouging speed
- It burns up impurities, degasses metal, leaving it metallurgically clean operates at all positions, even overhead

### Welding Positions



**Current Type**  
D.C.(+)

### Operating Data

Product Code	Diameter x Length (mm) / (inch)		Welding Current (A)	Package Weight (Kg)	Weight g / 100 pcs
3030100001	3.20 x 350	1/8 x 14"	180 - 240	5	3820
3030100002	4.00 x 350	5/32 x 14"	250 - 320	5	5620
3030100003	5.00 x 350	3/16 x 14"	350 - 450	5	8230

Approvals: GOST-R, CE, SEPRO

### Features and Applications

- Cleaning defective surfaces, removing faulty weld deposits, bevelling, gouging, elimination of tears, cutting metal parts to required size
- Made of copper-plated graphite. Used along with compressed air
- Special-type electrode holder is required
- Should be held horizontally to work
- Able to operate at all positions

### Welding Positions



**Current Type**  
D.C.(+)

### Operating Data

Product Code	Diameter x Length (mm) / (inch)	Pcs / Box	Welding Current (A)
6051500029	6.00 x 305	50	300 - 400
6051500046	8.00 x 305	50	350 - 450
6051500030	10.00 x 305	50	450 - 600
6051500047	12.00 x 305	50	500 - 700
6051500031*	13.00 x 430	50	800 - 100

\*Jointed Carbon Electrode

Approvals: GOST-R, SEPRO

### Standards

TS 9463 EN ISO 1071	: E C Z Fe-1
EN ISO 1071	: E C Z Fe-1
AWS A5.15	: E St

### Mechanical Properties

<b>Hardness</b> (cast iron) (HRC)
55

### Features and Applications

- Electrode with steel core
- Uses in suriacing of particularly high-hardness zones in cast iron materials
- High hardness, allowing direct application without a buffer layer on cast irons
- Specific applicability in surfacing of cast iron moulds used in the automotive industry, at radii, of deep drawing dies, and of casting edges
- Excellent results obtained in suriacing of launders for spherocasting as well as in hardfacing applications of cast iron materials
- Steady behavior of welding and arc start with almost no spattering

### Welding Positions



### Current Type

D.C.(+) / AC

### Operating Data

Product Code	Diameter x Length (mm) / (inch)		Welding Current (A)	Package Weight (Kg)	Weight g / 100 pcs
3030100010	2.50 x 350	3/32 x 14"	70-100	5	1852
3030100011	3.20 x 350	1/8 x 14"	80-130	5	3100

### Standards

TS 9463 EN ISO 1071	: E C Ni-CI 1
EN ISO 1071	: E C Ni-CI 1
AWS A5.15	: E Ni-CI

### Mechanical Properties

Tensile Strength (N/mm <sup>2</sup> )	Elongation ((L <sub>0</sub> =5d <sub>0</sub> ) (%))	Hardness (HB)
240-300	min. 5	~170 HB

### Features and Applications

- Low-heat-input manual electrode for joining old cast iron
- Electrode with pure nickel core for assembly and suriacing of broken or worn parts made of grey cast iron, also for reclamation of casting defects and for welding grey cast iron to steel
- Ni-cast electrode can be machinable by cutting tools
- Before welding large sections, preheating is useful
- Depending on quality of cast iron post weld may be needed
- Ensure that all areas to be welded are free from contaminant, remove casting defects such as sand inclusions, oil, damages of fatigue base material
- Controllable weld pool, excellent bonding, easy slag removal, dense, homogeneous and porosity-free deposit

### Welding Positions



### Current Type

D.C.(-)

### Operating Data

Product Code	Diameter x Length (mm) / (inch)		Welding Current (A)	Package Weight (Kg)	Weight g / 100 pcs
3030100004	2.50 x 300	3/32 x 12"	60 - 90	5	1830
3030100006	3.20 x 300	1/8 x 12"	90 - 120	5	2840
3030100008	4.00 x 350	5/32 x 14"	120 - 150	5	5150

Approvals: GOST-R, CE, SEPRO

### Standards

TS 9463 EN ISO 1071	: E C Ni-CI 1
EN ISO 1011	: E C Ni-CI 1
AWS A5.15	: E Ni-CI

### Mechanical Properties

Yield Strength (N/mm <sup>2</sup> )	Tensile Strength (N/mm <sup>2</sup> )	Elongation (L <sub>0</sub> =5d <sub>0</sub> ) (%)	Hardness (HB)
285	335	min. 5	~180

### Features and Applications

- Barium free (contain minimal emission for the environment), Non-conductive (better safety), basic graphite coated electrode with a nickel core wire
- Repair welding of problematic cast iron parts of irregular shapes
- Joint welding of cast iron parts and cast iron parts to steel parts
- Pre-heating to 200°C is recommended for thick-walled components
- Welding in short runs and preening are required

### Welding Positions



### Current Type

D.C.(+)

### Operating Data

Product Code	Diameter x Length (mm) / (inch)		Welding Current (A)	Weight g / 100 pcs
3030100009	3.20 x 300	1/8 x 12"	100 - 130	2840

Approvals: GOST-R, CE, SEPRO

### Standards

TS 9463 EN ISO 1071	: E C NiFe-CI 1
EN ISO 1071	: E C NiFe-CI 1
AWS A5.15	: E NiFe-CI

### Mechanical Properties

Tensile Strength (N/mm <sup>2</sup> )	Elongation ((L <sub>0</sub> =5d <sub>0</sub> ) (%))	Hardness (HB)
450	min. 10	~190 HB

### Features and Applications

- Include machine bases, pump casing, gear housing, gear boxes, engine blocks, compressors, machine frames, dies, flanges, tables, levers and generators
- Low-heat-input manual electrode for repair and maintenance of cast iron and for joining cast iron with steels or copper alloys. Its excellent weldability makes it easy to use in position.
- It also suitable for joining and building cast irons
- Weld deposit can be machinable by cutting tools
- It has high tensile strength and ductility and nodular graphite deposit resists to cracking
- For semi-hot and cold welding technique of parts made of grey cast iron, malleable cast iron or nodular graphite cast iron, some nickel and copper alloys such as housing and frames of machinery, subject to dynamic and heavy load

### Welding Positions



### MIG & TIG Wire

GeKaTec NiFe SG

### Current Type

D.C.(+)

### Operating Data

Product Code	Diameter x Length (mm) / (inch)		Welding Current (A)	Package Weight (Kg)	Weight g / 100 pcs
3030100012	2.50 x 250	3/32 x 10"	60 - 90	4	1560
3030100014	3.20 x 350	1/8 x 14"	80 - 120	5	3100
3030100016	4.00 x 350	5/32 x 14"	120 - 150	5	1560

Approvals: GOST-R, CE, SEPRO

### Standards

TS 9463 EN ISO 1071	: E C NiFe-CI 1
EN ISO 1071	: E C NiFe-CI 1
AWS A5.15	: E C NiFe-CI

### Mechanical Properties

Tensile Strength (N/mm <sup>2</sup> )	Elongation ( $L_0=5d_0$ ) (%)	Hardness (HB)
450	min. 10	~190 HB

### Features and Applications

- Include machine bases, pump casing, gear housing, gear boxes, engine blocks, compressors, machines frames, dies, flanges, tables, levers and generators
- Low-heat-input manuel electrode for repair and maintenance of cast iron and for joining cast iron with steels or copper alloys. Its excellent weldability makes it easy to use in position.
- It also suitable for joining and building cast irons
- Weld deposit can be machinable by cutting tools
- It has high tensile strength and ductility and nodular graphite deposit resists to cracking
- For semi-hot and cold welding technique of parts made of grey cast iron , malleable cast iron or nodular graphite cast iron, some nickel and copper alloys such as housing and frames of machinery, subject to dynamic and heavy load
- Weld metal recovery is more than 100 %

### Welding Positions



### MIG & TIG Wire

GeKaTec NiFe SG

### Current Type

D.C.(+)

### Operating Data

Product Code	Diameter x Length (mm) / (inch)		Welding Current (A)	Package Weight (Kg)	Weight g / 100 pcs
3030100017	3.20 x 350	1/8 x 14"	80 - 120	5	3100
3030100018	4.00 x 350	5/32 x 14"	120 - 150	5	4530

Approvals: GOST-R, CE, SEPRO

### Standards

TS EN ISO 14172	: E Ni 6182 (mod)(NiCr15Fe6Mn)
EN ISO 14172	: E Ni 6182 (mod)(NiCr15Fe6Mn)
AWS A5.11	: ~E NiCrFe-3

### Mechanical Properties

Yield Strength (N/mm <sup>2</sup> )	Tensile Strength (N/mm <sup>2</sup> )	Elongation ((L <sub>0</sub> =5d <sub>0</sub> ) (%))	Hardness (HB)
min. 360	660-715	40-45	200

### Features and Applications

- A high-alloyed nickel based electrode giving weld metal of Inconel-type resistant to cracking and impact at low temperatures
- Excellent result in the production of welding bead subject to various corrosive media and temperatures from -196° to 1000°C
- Mechanical properties of weld is not affected by heat treatment
- High resistance to heat, oxidation and corrosion, also suitable for nickel alloys such as Inconel and Incoloy
- Joint welding of different steels with each other
- Also include cement kiln rings , blast furnace components , chemical containers and liquid gas installations
- It is also used in crack repairing and joint welding

### Welding Positions



### MIG & TIG Wire

GeKaTec 7015 SG

### Current Type

D.C.(+)

### Operating Data

Product Code	Diameter x Length (mm) / (inch)		Welding Current (A)	Package Weight (Kg)	Weight g / 100 pcs
3030100020	2.50 x 250	3/32 x 10"	50-60	4	1600
3030100022	3.20 x 300	1/8 x 12"	70-95	5	2850
3030100023	4.00 x 350	5/32 x 14"	90-120	5	5000
3030100024	5.00 x 350	3/16 x 14"	130-160	5	6970

Approvals: GOST-R, CE, SEPRO



### Standards

AWS A5.11 : ~E NiCrFe-3

### Mechanical Properties

Yield Strength (N/mm <sup>2</sup> )	Tensile Strength (N/mm <sup>2</sup> )	Elongation ((L <sub>0</sub> =5d <sub>0</sub> ) (%))	Impact Strength (ISO-V/+20°C)	Impact Strength (ISO-V/-196°C)
min. 380	550	min. 30	min. 70J	min. 50J

### Features and Applications

- Nickel based basic type electrode
- Applicability in welding high-temperature steels and low-temperature alloyed or unalloyed steels, Nickel & Ni-alloys, casting steels
- Also include cement kiln rings, blast furnace components, chemical containers and liquid gas installations
- Used for the materials which are difficult to welding
- Electrode has a stabil arc
- The weld metal is resistant to cracking (cracking test results are suitable)
- Weldability in all position especially for vertical upward position (PF)

### Welding Positions



### Current Type

D.C.(+)

### Operating Data

Product Code	Diameter x Length (mm) / (inch)	Welding Current (A)	Package Weight (Kg)	Weight g / 100 pcs
3030100025	2.50 x 250	70 - 100	5	2640
3030100026	3.20 x 300	80 - 130	5	4620
3030100029	4.00 x 350	130 - 160	5	5420

Approvals: GOST-R, SEPRO

### Standards

TS EN ISO 3581 - A	: E 29 9 R 12
EN ISO 3581 - A	: E 29 9 R 12
AWS A5.4	: ~E 312-16

### Mechanical Properties

Yield Strength (N/mm <sup>2</sup> )	Tensile Strength (N/mm <sup>2</sup> )	Elongation ((L <sub>0</sub> =5d <sub>0</sub> ) (%))	Hardness (HB)
min. 450	790 - 860	20 - 25	250 - 300

### Features and Applications

- Include rebuilding gear teeth, repairing cracks in casing, buffering layers and repairs on earth moving and drilling equipment and rebuilding worn shafts
- Materials of low weldability such as unalloyed high carbon steels, low and high alloyed steels, tool steels, high speed steels, manganese hardening steels, rail steels and iron based cast materials
- It is also extremely usefull for repairs where the base metal is unknown grade steels
- High alloyed special manuel electrode for joining a broad range of difficult-to-weld metals including special, austenitic-manganese, air hardening materials for dissimilar joining
- Rutile type austenitic-ferritic electrode containing 29 9 Cr-Ni-Cobalt
- Weld metal hardness increases by work hardening and cold forming
- Depending on the ferrit content suitable for designed for joining difficult-to- weld steels, welding of dissimilar joints and rebuilding or buffering before hardsurfacing

### Welding Positions



### Current Type

D.C.(+) / AC

### Operating Data

Product Code	Diameter x Length (mm) / (inch)		Welding Current (A)	Package Weight (Kg)	Weight g / 100 pcs
3030100032	2.50 x 250	3/32 x 10"	40-70	4	1350
3030100034	3.20 x 350	1/8 x 14"	70-100	5	3350
3030100036	4.00 x 350	5/32 x 14"	90-140	5	4500

Approvals: GOST-R, CE, SEPRO

### Standards

TS EN ISO 3581 - A	: E 29 9 R 52
EN ISO 3581 - A	: E 29 9 R 52
AWS A5.4	: ~E 312-26

### Mechanical Properties

Tensile Strength (N/mm <sup>2</sup> )	Elongation ((L <sub>0</sub> =5d <sub>0</sub> ) (%))	Hardness (HB)
790 - 830	min. 20	220 - 300

### Features and Applications

- It is also used for joining difficult-to-weld steels, building thick machine parts, bridge building materials, low and high alloyed structural steels, cast steels, roller presses, extruder screws, cuppling boxes and sleeves, joining mechanically welded parts and coating turbine components, seats of super heater steam valves and heat exchangers, etc
- Rutile electrode with high deposition rate containing 29 9 Cr-Ni-Cobalt. Suitable for joining and build up welding of materials have tendency to cracking due to their high tensile and impact strength

### Welding Positions



### Current Type

D.C.(+) / AC

### Operating Data

Product Code	Diameter x Length (mm) / (inch)		Welding Current (A)	Package Weight (Kg)	Weight g / 100 pcs
3030100030	3.20 X 350	1/8 X 14"	100-160	5	5100
3030100031	4.00 X 350	5/32 X 14"	140-200	5	7600

Approvals: GOST-R, CE, SEPRO

### Standards

TS EN ISO 3581 - A	: E Z 18 9 MnMo R 53
EN ISO 3581 - A	: E Z 18 9 MnMo R 53
AWS A5.4	: ~E 307-26

### Mechanical Properties

Tensile Strength (N/mm <sup>2</sup> )	Elongation ((L <sub>0</sub> =5d <sub>0</sub> ) (%))	Hardness (HB)	
		As Welded	After Working
600 - 700	min. 40	220	410

### Features and Applications

- Rebuilding or buffering before hardsurfacing and surfacing of rails and railway equipments
- Welding 12-14 % Manganese steels, armour and hard to weld steels
- In cement industry for welding buffer layer of mili hammers, rollers and friction plates of crushers etc
- Rutile type austenitic electrode containing 18 Cr / 8 Ni with manganese
- The corrosion resistant weld metal is also resistant to impact, pressure, cavitation and thermal shocks
- Weld metal hardness increases by cold forming and work hardening

### Welding Positions



### Current Type

D.C.(+)

### Operating Data

Product Code	Diameter x Length (mm) / (inch)		Welding Current (A)	Package Weight (Kg)	Weight g / 100 pcs
3030100037	3.20 x 350	1/8 x 14"	90-130	5	5050
3030100038	4.00 x 350	5/32 x 14"	130-160	5	7500
3030100039	5.00 x 350	3/16 x 14"	160-190	5	11500

**Approvals:** GOST-R, CE, SEPRO

### Standards

TS EN ISO 3581 - A	: E Z 13 B 62
EN ISO 3581 - A	: E Z 13 B 62
AWS A5.4	: E 410 - 25 (mod.)

### Mechanical Properties

Yield Strength (N/mm <sup>2</sup> )	Tensile Strength (N/mm <sup>2</sup> )	Elongation ((L <sub>0</sub> =5d <sub>0</sub> ) (%))
740	950 - 1100	min. 15

### Features and Applications

- The application, of cavitation resistancy, build up welding on parts working in water, stream and seawater, Hydroelectric power plants and turbine blades,propellersparts
- Basic type high recovery electrode for use in joint welding and build up welding application to 12-14 % Cr ferritic-martensitic stainless steel and cast steels
- It is for build up welding on impermeable surfaces of gas, water and stream armatures of unalloyed and low alloyed steels for service temperatures up to 450°C

### Welding Positions



### Current Type

D.C.(+)

### Operating Data

Product Code	Diameter x Length (mm) / (inch)		Welding Current (A)	Package Weight (Kg)	Weight g / 100 pcs
3030100046	2.50 x 350	3/32 x 14"	60-90	4	2510
3030100047	3.20 x 350	1/8 x 14"	90-120	5	3700
3030100048	4.00 x 350	5/32 x 14"	110-160	5	5540
3030100049	5.00 x 350	3/16 x 14"	150-1 90	5	6970

Approvals: GOST-R, CE, SEPRO

### Standards

TS EN 14700	: E Fe 1
EN 14700	: E Fe 1
DIN 8555	: E 1 - UM - 300

### Mechanical Properties

<b>Hardness</b> (HB)
325 - 350

### Features and Applications

- Weld metal has high machinability and high efficiency
- Risk of cracking is very low
- Used in joining of high tensile strength steels, some parts exposed to impact and abraision as a buffering and filler electrode
- Rails, switches and crossings, ladles, gear parts, crane wheels are typical application areas of this electrode

### Welding Positions



### Flux Cored Wire

GeKaTec HARDCOR 300 G

GeKaTec HARDCOR 300 O

### Current Type

D.C.(+) / AC

### Operating Data

Product Code	Diameter x Length (mm) / (inch)		Welding Current (A)	Package Weight (Kg)	Weight g / 100 pcs
3030100052	3.20 x 350	1/8 x 14"	100-140	5	3645
3030100053	4.00 x 350	5/32 x 14 "	140-180	5	5300

**Approvals:** GOST-R, CE, SEPRO

### Standards

TS EN 14700	: E Fe 9
EN 14700	: E Fe 9
DIN 8555	: E 7-UM-250KP

### Mechanical Properties

Hardness (HB)	
As Welded	After Working
250	550

### Features and Applications

- Suitability for uses in hardfacing of high-manganese steels
- Most common applications in hardfacing of various equipment parts that are exposed to deep impacts, pressure and wearing in cement, mining and earth-moving industries
- High resistance to impact and to friction
- Increasing hardness of weld metal after operations including its exposure to impact and friction.
- High toughness
- Requirement of electrode holding in perpendicular direction to work piece, by maintaining short and uniform - exposed arc
- Requirement of two-pass buffer-layering with the electrode GeKaTec 660 HD for providing good connection and crack protection in case of thick-layer hardfacing operations
- Requirement of re-drying at 300°C for 2 hours

### Welding Positions



### Flux Cored Wire

GeKaTec HARDCOR 660 0

### Current Type

D.C.(+) / AC

### Operating Data

Product Code	Diameter x Length (mm) / (inch)		Welding Current (A)	Package Weight (Kg)	Weight g / 100 pcs
3030100050	3.20 X 350	1/8 X 14"	110-140	5	4790
3030100051	4.00 X 350	5/32 X 14"	150-180	5	7320

**Approvals:** GOST-R, CE, SEPRO

### Mechanical Properties

Hardness As Welded	After Working
250 - 300 (HB)	400 - 450 (HB)

### Features and Applications

- Kavtam is Cobalt, Chromium, Manganese and Silicon alloyed manual stick electrode and used for hardfacing work pieces which are subjects to severe cavitation and erosion
- The weld deposit is also resistant to corrosion, cavitation and erosion at high temperatures.
- Main applications are hardfacing of hydraulic turbines, pumps, valves, casings, rotors
- The hardness after welding is 250-300HB and after workhardened is approximately 450HB
- Requirement of re-drying for 2 hours at 300°C

### Welding Positions



### Current Type

D.C.(+) / AC

### Operating Data

Product Code	Diameter x Length (mm) / (inch)		Welding Current (A)	Weight g / 100 pcs
3030100090	3.20 x 350	1/8 x 14"	90 - 130	4930

Approvals: GOST-R, SEPRO



### Standards

TS EN 14700	: E Z Fe7
EN 14700	: E Z Fe7
DIN 8555	: E 6-UM-55 GRP

### Mechanical Properties

<b>Hardness (HRC)</b>
55

### Features and Applications

- Applications include shear blades, moulds and related parts for pressure casting, rollers, crusher jaws and other parts which are required to resist the wear under high impact with abrasion, also excavator digger parts made of carbon steel with unalloyed core, all types of alloyed steels or manganese hardened steels
- Heavy coated high alloy hardfacing electrode for parts requiring extremely hard surface
- Excellent resistance to wear caused by high pressure shocks, abrasion and cracking
- It has high deposition rate, easy striking and contact weldability and allows super imposed multi-pass coatings

### Welding Positions



### Flux Cored Wire

GeKaTec HARDCOR 600 G

### MAG Wire

GeKaTec 600 G

### Current Type

D.C.(+)

### Operating Data

Product Code	Diameter x Length (mm) / (inch)		Welding Current (A)	Package Weight (Kg)	Weight g / 100 pcs
3030100054	2.50 x 350	3/32 x 14"	90 - 120	5	2800
3030100055	3.20 x 350	1/8 x 14"	125 - 160	5	4400
3030100056	4.00 x 350	5/32 x 14"	160 - 220	5	7000
3030100057	5.00 x 350	3/16 x 14"	220 - 250	5	11600

**Approvals:** GOST-R, CE, SEPRO

### Standards

TS EN 14700	: EZ Fe 14
EN 14700	: EZ Fe 14
AWS A5.13	: -E FeCr-A8
DIN 8555	: E 10-UM-60 GRZ

### Mechanical Properties

Hardness (HRC)
62 - 64

### Features and Applications

- Application includes dredger bucket edges, mixer blades, sand pumps, conveyor screws and chains, hammers, crushers, guide plates used in brick and earth, mine, cement industries
- Required hardness obtainable in single run
- Heavy coted electrode with high deposition rate particularly for hardfacing parts subjected to heavy abrasion together with medium impact. It is used for hardfacing of all unalloyed carbon steels and 12-14% manganese steels

### Welding Positions



### Flux Cored Wire

GeKaTec HARDCOR 63 0

### Current Type

D.C. (+/-)

### Operating Data

Product Code	Diameter x Length (mm) / (inch)		Welding Current (A)	Package Weight (Kg)	Weight g / 100 pcs
3030100058	3.20 x 350	1/8 x 14"	100 - 130	5	4980
3030100059	4.00 x 350	5/32 x 14"	130 - 160	5	7710
3030100060	5.00 x 350	3/16 x 14"	160 - 190	5	11970

Approvals: GOST-R, SEPRO, CE

### Standards

TS EN 14700	: E Fe 16
EN 14700	: E Fe 16
DIN 8555	: E 10-UM-65 R

### Mechanical Properties

Hardness (HRC)	
Pass 1	Pass 2
61 - 65	64 - 68

### Features and Applications

- A special kind of electrode basically containing Chromium-boron carbide alloy
- Applicability in hardfacing of parts that are exports to wearing in mines or quarries, in soil or cement industries and in similar fields
- Uses in hardfacing of all wear-resistant parts such as buckets or their teeth of heavy construction equipments, drill bits, twists used in brickworks, mud pumps, mixer blades, agricultural machines, crusher jaws and rolls as well as springs
- Very high resistance to wear
- High fusibility
- High recovery of weld metal
- Machinability by grinding only
- Recommended buffer layering through a more basic type of electrode or through the GeKaTec electrode 660 HD
- Holding required in perpendicular direction to that of the welding work

### Welding Positions



### Current Type

D.C.(+) / AC

### Operating Data

Product Code	Diameter x Length (mm) / (inch)		Welding Current (A)	Package Weight (Kg)	Weight g / 100 pcs
3030100061	3.20 x 350	1/8 x 14"	110 - 150	5	5200
3030100062	4.00 x 350	5/32 x 14"	140 - 200	5	7160

**Approvals:** GOST-R, CE, SEPRO

**Standards**

TS EN 14700	: E Co 1
DIN 8555	: E 20-UM-300-CKTL

**Chemical Composition of  
Weld Metal % (Typical)**

C	Mo	Co	Cr	Ni
0.3	5.6	Rest	26.0	3.0

**Mechanical Properties**

Hardness (HRC)	
After Welding	After Working
30 - 32	45

**Features and Applications**

- It is used for hardfacing of materials subject to impact, pressure, abrasion, corrosion and high temperature or combination of these
- Die molds, extruder, screws, hot cutting and working boiler steels, shafts, pumps, valves and seats
- Weld metal has work hardening ability under impact and friction
- Before welding, it must be buffering with 307 and 309 electrodes

**Welding Positions**

**Current Type**

D.C.(+)/ AC

**Operating Data**

Product Code	Diameter x Length (mm) / (inch)		Welding Current (A)	Package Weight (Kg)	Weight g / 100 pcs
3030100070	3.20 x 350	1/8 x 14"	90 - 120	5	3500

**Approvals:** GOST-R, CE, SEPRO

**Standards**

TS EN 14700	: E Co 2
EN 14700	: E Co 2
AWS A5.13	: E CoCr A
DIN 8555	: E 20-UM-45 CTZ

**Chemical Composition of  
Weld Metal % (Typical)**

C	Cr	W	Co
1.1	28	4	Rest

**Mechanical Properties**

Hardness (HRC)
42

**Features and Applications**

- Valve shutters and caps, wood working tools, saw chains and slide ways, hot shear blades, pump components, hot pressing tools, valve seats, ingot tong ends, conveyor screws, for chemical and food processing industries
- GeKaTec COBALT 6 is a versatile cobalt containing alloy with high mechanical impact and high temperature resistance
- It is used primarily on workpieces exposed to high alternating temperatures and corrosion
- GeKaTec COBALT 6 deposit is especially suited for carbon steels, stainless steel, nickel, monel and manganese steels

**Welding Positions**

**Flux Cored Wire**

GeKaTec HARDCOR COBALT 6

**TIG Wire**

GeKaTec COBALT 6 TIG

**Current Type**

D.C.(+) / AC

**Operating Data**

Product Code	Diameter x Length (mm) / (inch)		Welding Current (A)	Package Weight (Kg)	Weight g / 100 pcs
3030100071	3.20 x 350	1/8 x 14"	90 - 120	5	3500
3030100072	4.00 x 350	5/32 x 14"	135 - 160	5	5200

**Approvals:** GOST-R, CE, SEPRO

**Standards**

TS EN 14700	: E Co3
EN 14700	: E Co3
AWSA5.13	: E CoCr B
DIN 8555	: E 20-UM-50 CTZ

**Chemical Composition of  
Weld Metal % (Typical)**

C	Cr	W	Co
1.4	29	8	Rest

**Mechanical Properties**

Hardness (HRC)
48 - 52

**Features and Applications**

- Include tools to cut paper, cardboard, floor covering, roofing, wood, screw conveyors for chemical and food industries
- Electrode with Co-Cr-W alloyed core wire
- Hard surfacing of parts subjected to either the single or combined effect of heavy to metal wear abrasion, high temperatures (ranging from 500 to 800°C occasionally up to 1100°C) and corrosive environments
- 307 and 309 stainless steel electrode can be used as buffering

**Welding Positions**

**Flux Cored Wire**

GeKa HARDCOR COBALT 12

**TIG Wire**

GeKaTec COBALT 12 TIG

**Current Type**

D.C.(+) / AC

**Operating Data**

Product Code	Diameter x Length (mm) / (inch)		Welding Current (A)	Package Weight (Kg)	Weight g / 100 pcs
3030100068	3.20 x 350	1/8 x 14"	90 - 120	5	3530
3030100069	4.00 x 350	5/32 x 14"	130 - 160	5	5390

**Approvals:** GOST-R, CE, SEPRO

### Standards

TS EN 14700	: E Co 3
EN 14700	: E Co 3
AWSA5.13	: E CoCr C
DIN 8555	: E 20-UM-55 CTZ

### Chemical Composition of Weld Metal % (Typical)

C	Cr	W	Co
2.1	31	13	Rest

### Mechanical Properties

Hardness (HRC)
50 - 57

### Features and Applications

- GeKaTec COBALT 1 is cobalt based hard facing electrode
- It is used for hard facing of valves and fittings which requires resistance to high temperature , pressure and corrosion, sliding stressing metal-to-metal and is recommended in welding of cutter tools, screw conveyors, wear rings and guide rails

### Welding Positions



### Flux Cored Wire

GeKaTec HARDCOR COBALT 1

### TIG Wire

GeKaTec COBALT 1 TIG

### Current Type

D.C.(+) / AC

### Operating Data

Product Code	Diameter x Length (mm) / (inch)		Welding Current (A)	Package Weight (Kg)	Weight g / 100 pcs
3030100066	3.20 x 250	1/8 x 14"	90 - 120	5	3660
3030100067	4.00 x 350	5/32 x 14"	130 - 160	5	5200

Approvals: GOST-R, CE, SEPRO

### Standards

TS EN 14700	: E Z Fe 8
EN 14700	: E Z Fe 8
DIN 8555	: E 3-UM-50 GTZ

### Mechanical Properties

Hardness (HRC)	
As Welded	After Heat Treatment
45 - 50	48 - 54

### Features and Applications

- Include spining rotors, for glass-wool production, draw plates, stamping trimming dies, klin parts, pump shafts, chucks etc
- Manuel electrode for anti-wear protective coatings on tool-steel parts working under very hot or cold conditions
- Electrode with Co, Cr, Mo alloys gives excellent metal / metal friction resistance at high temperatures
- Ideal for use as surfacing with no risk of cracking

### Welding Positions



### Flux Cored Wire

GeKaTec HARDCOR 50 G

### Current Type

D.C.(+)

### Operating Data

Product Code	Diameter x Length (mm) / (inch)		Welding Current (A)	Package Weight (Kg)	Weight g / 100 pcs
3030100073	2.50 x 250	3/32 x 10"	75	4	1600
3030100074	3.20 x 350	1/8 x 14"	110	5	3680

Approvals: GOST-R, CE, SEPRO



### Standards

TS EN 14700	: E Ni 2
EN 14700	: E Ni 2
DIN 8555	: E ~23-UM-250-CKPZ

### Mechanical Properties

Tensile Strength (N/mm <sup>2</sup> )	Elongation ((L <sub>0</sub> =5d <sub>0</sub> ) (%))	Hardness		
		As Welded	After Heating 800°C/4h	After Working
min. 660	min. 740	270-320HB	380-450HB	~550 HV

### Features and Applications

- Dies, mandrels, raci for hot extrusion of profiles, continuous casting guide tables, feed rolls, blades for hot shearing, furnace components, rolling mill inlet guides
- Electrode highly alloyed with chromium, Cobalt, Nickel, Molybdenum and Tungsten
- It is used for anti-wear protective coatings on low and high alloy steels, Nickel alloys and refractory steels
- It gives high strength and high creep resistance and temperatures up to 1200°C also resistance to thermal cycling shocks and abrasion
- It has work hardenable deposit which is high mechanical pressures and very high resistance to strong oxidising agents, mixture of acids, chlorinated chemicals

### Welding Positions



### Current Type

D.C.(+) / AC

### Operating Data

Product Code	Diameter x Length (mm) / (inch)		Welding Current (A)	Package Weight (Kg)	Weight g / 100 pcs
3030100082	3.20 x 300	1/8 x 12"	120 - 170	5	3600

Approvals: GOST-R, CE, SEPRO

### Standards

TS EN 14700	: E Fe 7
EN 14700	: E Fe 7
DIN 8555	: E5-UM-400

### Mechanical Properties

Hardness (HB)
440 - 460

### Features and Applications

- Rutile type electrode with high recovery
- Welding for stainless of similar chemical compositions or cast steels having Cr of - 12%.
- Used of surfacing of carbon steels to resist corrosion, erosion and abrasion
- Used in Chemical Industry, Steel Industry and also at continuous casting rolls and surfacing steel mill rolls
- A specified hardness value can be obtained in one or two passes depending on carbon content of the base material

### Welding Positions



### Current Type

D.C.(+) / AC

### Operating Data

Product Code	Diameter x Length (mm) / (inch)	Welding Current (A)	Weight g / 100 pcs
3030100079	3.20 x 350	100 - 140	4175
3030100081	4.00 x 450	140 - 180	8750

Approvals: GOST-R, CE, SEPRO

### Standards

TS EN 14700	: E Z Fe8
EN 14700	: E Z Fe8
DIN 8555	: E3-UM-40 PT

### Mechanical Properties

<b>Hardness</b> (HB)
~400

### Features and Applications

- Resistant to heat as well as to abrasion, due to its technical features also resistant to high temperature and pressure
- This especially used for the worn out parts of tool steels of surfacing jobs
- Main application fields are hardfacing of hot cutting blades, hammers, grinders, forming moulds, casting moulds, bravely and cylinder surfaces
- Also provides economical solutions as it is used on any kind of steel for surfacing without the use of a special tool steel
- Basic coated, Chrome-Molly alloyed, calm arc, synthetic electrode with deep penetration.
- Weld metal efficiency is - 120%
- It is recommended that the base metal should be pre-heated up to 400°C and after welding is completed
- It should be cooled down slowly
- Electrode should be baked for 2 hours at 300°C temperature

### Welding Positions



### MIG Wire

GeKaTec TOOL 40 SG

### Current Type

D.C.(+) / AC

### Operating Data

Product Code	Diameter x Length (mm) / (inch)		Welding Current (A)	Package Weight (Kg)	Weight g / 100 pcs
3030100076	2.50 x 350	3/32 x 14"	60 - 90	5	2100
3030100077	3.20 x 350	1/8 x 14"	100 - 140	5	3760
3030100078	4.00 x 350	5/32 x 14"	130 - 180	5	5600

Approvals: GOST-R, CE, SEPRO

### Standards

TS EN 14700	: EZ Fe 8
EN 14700	: EZ Fe 8
DIN 8555	: E 3-UM-60 ST

### Mechanical Properties

<b>Hardness</b> (after working) (HRC)
58

### Features and Applications

- A special kind of rutile-coated electrode for hardfacing of hot- and cold-work tool steels.
- Suitability for uses in hardfacing of hot or cold-work steels, edges of cutting dies, blades of hot-shearing machines, punching tools, rolls and impact punches, machinery tools for die-casting; at temperatures up to 550°C
- Applicability in hardfacing of steel materials such as ST50, ST60, ST70 as well as in re-manufacturing of tools
- Requirements of pre-annealing at 400°C of the base metal, welding through hammering, not exceeding the pre-annealing temperature by welding, and of very slow cooling of weld metal
- Variability of weld metal's hardness through heat treatment

### Welding Positions



### MIG Wire

GeKaTec TOOL 55 SG

### Current Type

D.C.(-) / AC

### Operating Data

Product Code	Diameter x Length (mm) / (inch)		Welding Current (A)	Package Weight (Kg)	Weight g / 100 pcs
3030100084	2.50 x 350	3/32 x 14"	50 - 70	4	2070
3030100085	3.20 x 350	1/8 x 14"	90 - 120	5	3270

**Approvals:** GOST-R, CE, SEPRO

### Standards

TS EN 14700	: E Fe 4
EN 14700	: E Fe 4
AWS A5.13	: E Fe 5-A
DIN 8555	: E 4-UM-60 S

### Mechanical Properties

<b>Hardness</b> (after working) (HRC)
60 - 62

### Features and Applications

- The weld deposit is the similar to the high speed steel so it is used for reconditioning the surface and cutting edges of hot working tool steels and tools made from unalloyed steels.
- Main applications are the tools exposed to heat, adhesion and impact wears
- It is recommended that preheating to 400°C before the welding of high carbon steels and tool steels
- Re-dry for 2 hours at 300°C - 350°C

### Welding Positions



### MIG Wire

GeKaTec TOOL 60 SG

### Current Type

D.C.(+) / AC

### Operating Data

Product Code	Diameter x Length (mm) / (inch)		Welding Current (A)	Package Weight (Kg)	Weight g / 100 pcs
3030100086	3.20 x 350	1/8 x 14"	90 - 120	5	3290

**Approvals:** GOST-R, CE, SEPRO

### Standards

TS EN 14700	: E Fe 7
EN 14700	: E Fe 7
DIN 8555	: E 5-UM-400

### Mechanical Properties

Hardness (HRC)
54 - 57

### Features and Applications

- For hot work tool steels with high welding efficiency
- Especially used in repair welding of molds and hot work tool steels
- No cracking in the weld metal after welding
- Re-drying: 300°C / 2h

### Welding Positions



### Current Type

D.C.(+) / AC

### Operating Data

Product Code	Diameter x Length (mm) / (inch)		Welding Current (A)	Weight g / 100 pcs
3030100088	4.00 x 450	5/32 x 18"	150 - 190	7930
3030100087	5.00 x 450	3/16 x 18"	180 - 240	12600

Approvals: SEPRO

**Standards**

AWS A5.6 : E Cu

**Chemical Composition of  
Weld Metal % (Typical)**

Cu
min.99

**Mechanical Properties**

Tensile Strength (N/mm <sup>2</sup> )	Elongation ((L <sub>0</sub> =5d <sub>0</sub> ) (%))	Hardness (HB)
min. 200	min. 25	55

**Features and Applications**

- Electrode made of pure copper
- Uses in joint-welding and surfacing operations on pure copper or on copper alloys
- Applicability in joint- welding of boilers, heat exchangers, or, of copper tubes, copper busbars used in electrotechnics, copper busbars as well as in copper surfacing on steel materials
- Requirement of applying as high current as possible in joint- welding
- Pre-heating requirement of base materials of copper or copper alloys at temperatures of 400°C - 450°C for all welding applications on them

**Welding Positions**

**MIG Wire**

GeKa R1 L

**TIG Wire**

GeKaTec S1 L

**Current Type**

D.C.(+) / AC

**Operating Data**

Product Code	Diameter x Length (mm) / (inch)		Welding Current (A)	Package Weight (Kg)
6031200015	3.20 x 350	1/8 x 14"	90 - 120	5
6031200016	4.00 x 350	5/32 x 14"	120 - 150	5

**Approvals:** GOST-R, SEPRO

**Standards**

AWS A5.6 : E CuSn - C

**Chemical Composition of  
Weld Metal % (Typical)**

Sn	Cu
7.0-9.0	Rest

**Mechanical Properties**

Tensile Strength (N/mm <sup>2</sup> )	Elongation ((L <sub>0</sub> =5d <sub>0</sub> ) (%))	Hardness (HB)
min. 420	min. 25	155

**Features and Applications**

- Tin bronze electrode for coating and repairing parts made of copper, bronze, brass and for joining of these to steels, cast iron, nickel, nickel alloys
- Good resistance to corrosion, particularly attack by acetone and dry ammoniac, industrial atmospheres and salty air, seawater and acids
- It is also resistant to metal / metal friction
- Applications include joining welding of machinery components made of copper and its alloys, steels and cast steels a grey cast iron, such as piston arms, sprockets, guides, turbine and centrifugal, blades, fans, ship's screw propellers, motor collector and valve seats, for the application of braze surfacing on this materials

**Welding Positions**

**MIG Wire**

GeKa R4 L

**TIG Wire**

GeKaTec S4 L

**Current Type**

D.C.(+) / AC

**Operating Data**

Product Code	Diameter x Length (mm) / (inch)		Welding Current (A)	Package Weight kg
6031200023	3.20 x 350	1/8 x 14"	80 - 120	5
6031200024	4.00 x 350	5/32 x 14"	120 - 150	5

**Approvals:** GOST-R, SEPRO



**Standards**
**Chemical Composition of  
Weld Metal % (Typical)**

AWS A5.6 : E CuAl - A2 (E CuAl8)

Fe	Al	Cu
0.5-5.0	6.5-9.5	Rest

**Mechanical Properties**

Tensile Strength (N/mm <sup>2</sup> )	Elongation ( $L_0=5d_0$ ) (%)	Hardness (HB)
min. 650	min. 20	205

**Features and Applications**

- It is used for safely repairs all grades of aluminum bronzes and overlays on cast irons, steels and copper which are subject to corrosion, cavitation, erosion and metal to metal wears
- Joining and surfacing parts subject to service in marine environments and seawater

**Welding Positions**

**MIG Wire**

GeKa R4 L

**TIG Wire**

GeKaTec S4 AL

**Current Type**

D.C.(+) / AC

**Operating Data**

Product Code	Diameter x Length (mm) / (inch)	Welding Current (A)	Package Weight (Kg)
6031200017	3.20 x 350 / 1/8 x 14"	70 -110	5

**Approvals:** GOST-R, SEPRO

**Standards**

TS 9604	: EL-AISI 5
AWS A5.3	: E 4043

**Chemical Composition of  
Weld Metal % (Typical)**

Si	Al
4.5 - 5.5	Rest

**Mechanical Properties**

Tensile Strength (N/mm <sup>2</sup> )	Elongation ((L <sub>0</sub> =5d <sub>0</sub> ) (%))	Hardness (HB)
160 - 190	min. 10	50

**Features and Applications**

- Include also engine blocks, gear cases, engine gear box unit, miscellaneous components in light alloys, stroge tanks, containers, vessels, repair works on various kind of aluminium materials
- Manuel welding electrode recommended for production and maintenance applications including repair of cracks, casting defects and building up sections also broken parts
- Suitable for made of aluminium applications
- Before welding on thick section preheat at about 200°C is recommended

**Welding Positions**

**MIG Wire**

GeKa AISi 5

**TIG Wire**

GeKa AISi 5 TIG

**Current Type**

D.C.(+) / AC

**Operating Data**

Product Code	Diameter x Length (mm) / (inch)		Welding Current (A)	Package Weight (Kg)
6031200019	2.50 x 350	3/32 x 14"	50 - 80	2
6031200020	3.20 x 350	1/8 x 14"	70 - 100	2
6031200021	4.00 x 350	5/32 x 14"	90 - 130	2

**Approvals:** GOST-R, SEPRO

**Standards**

TS 9604 : EL-AISi 12

**Chemical Composition of  
Weld Metal % (Typical)**

Si	Al
11.0-13.5	Rest

**Mechanical Properties**

Tensile Strength (N/mm <sup>2</sup> )	Elongation ( $L_0=5d_0$ ) (%)	Hardness (HB)
160 - 200	5 - 10	55 - 60

**Features and Applications**

- Low-heat-input manual electrode for joining cast aluminium alloys, plus repair and maintenance of sheet aluminium and aluminium casting, including rebuilding, filling cracks, breaks, shrink holes and missing bits
- Excellent welding properties, good arc striking, clean flat flow, dense poreless seams
- Thanks to these characteristics it enables perfect joining on plates up to 2 mm thick
- The electrode is hardly hygroscopic and therefore stores well

**Welding Positions**

**MIG Wire**

GeKa AISi 12

**TIG Wire**

GeKa AISi 12 TIG

**Current Type**

D.C.(+)

**Operating Data**

Product Code	Diameter x Length		Welding Current (A)	Package Weight kg
	(mm)	(inch)		
6031200025	2.50 x 350	3/32 x 14"	70 - 80	2
6031200026	3.20 x 350	1/8 x 14"	90 - 100	2
6031200027	4.00 x 350	5/32 x 14"	110 - 130	2

**Approvals:** GOST-R, SEPRO

## Standards

TS 9604	: EL-AI 99.5
AWS A5.3	: E 1100

## Mechanical Properties

Tensile Strength (N/mm <sup>2</sup> )	Elongation ((L <sub>0</sub> =5d <sub>0</sub> ) (%))	Hardness (HB)
70 - 100	min. 30	30 - 80

## Features and Applications

- Include pipes, vessels, hoppers, vats, containers heat exchangers, air conditioning, decorative panels, slideways where electrolytic treatment or anodisation is foreseen
- Excellent welding properties, excellent resistance to salt-water and industrial corrosion, good arc striking, clean flat flow, dense poreless seams
- Low-heat-input manual electrode for joining wrought aluminium alloys
- Electrode with special coating for joining and repairing of pure aluminium, Al-Mg-Mn, Al-Mg alloys

## Welding Positions



## MIG Wire

GeKa Al 99.5

## TIG Wire

GeKa Al 99.5 TIG

## Current Type

D.C.(+)

## Operating Data

Product Code	Diameter x Length (mm) / (inch)	Welding Current (A)	Package Weight (Kg)
6031200028	2.50 x 350 / 3/32 x 14"	60 - 80	2
6031200029	3.20 x 350 / 1/8 x 14"	80 - 100	2
6031200011	4.00 x 350 / 5/32 x 14"	1100 - 130	2

Approvals: GOST-R, SEPRO

**Standards**

AWS A5.14 : ER - Ni 1

**Chemical Composition of  
Welding Wire % (Typical)**

Ni	C	Si	Mn	Ti
Rest	0.02	0.4	0.4	3.0

**Mechanical Properties**

Yield Strength (N/mm <sup>2</sup> )	Tensile Strength (N/mm <sup>2</sup> )	Impact Strength (ISO-V/+20°C)	Elongation ((L <sub>0</sub> =5d <sub>0</sub> ) (%))
min. 300	min. 500	min. 250 J	min. 30

**Typical Base Material Grades**

- 2.4061 , 2.4116 , 2.4170 as well as copper and its combinations with steel castings

**Features and Applications**

- Use in various applications of joint-welding of the materials Nickel 200/201 or stainless steels. Suitability for use in welding of carbon steels or of high-alloyed nickel or nickel-copper alloys
- Required use of Ar (I1) as shielding gas in TIG welding

**Welding Positions**

**Current Type**

TIG D.C.(-)

**Operating Data**

Product Code	Diameter x Length (mm) / (inch)		Package Weight (Kg)
6031100304	1.20	0,047"	15
6031100110	2,4 x 1000	3/32 x 39"	5

**Approvals:** GOST-R, SEPRO

**Standards**

TS EN ISO 18274	: S Ni 4060 (NiCu 30 Mn 3 Ti)
EN ISO 18274	: S Ni 4060 (NiCu 30 Mn 3 Ti)
AWS A5.14	: ER NiCu 7

**Chemical Composition of  
Welding Wire % (Typical)**

Al	Si	Cu	C	Ni	Mn	Fe	Ti
1.25	1.25	Rest	0.15	65	3.5	2.5	2.0

**Mechanical Properties**

Yield Strength (N/mm <sup>2</sup> )	Tensile Strength (N/mm <sup>2</sup> )	Impact Strength (ISO-V/+20°C)	Elongation ((L <sub>0</sub> =5d <sub>0</sub> ) (%))
300	500	120 J	35

**Typical Base Material Grades**

- NiCu 30 Fe (2.4360) - NiCu 30 Al (2.4375) - UNS N04400, N05500 - Alloy 400 ASTM B 127, B 165, MONEL400, MONEL 405, 2.4377

**Features and Applications**

- It is used for welding of Nickel Copper alloys to steels and copper alloys to steel, gray iron to steels and stainless steels
- Weld metal has perfect stainless properties, used in sea water applications, chemical and petrochemical industry and ship equipments
- Shielding Gas : MIG : Argon /TIG : Argon

**Welding Positions**

**Current Type**

MIG D.C. (+) / TIG D.C.(-)

**Operating Data**

Product Code	Diameter x Length (mm) / (inch)	Welding Current (A)	Package Weight (Kg)
6031100305	1.00	0,040"	15
6031100306	1.20	0,047"	15
6031100307	2,4 x 1000	3/32 x 39"	5

Approvals: GOST-R, SEPRO

**Standards**

TS EN ISO 18274	: S Ni 6625 (NiCr22Mo9Nb)
EN ISO 18274	: S Ni 6625 (NiCr22Mo9Nb)
AWS A5.14	: ER Ni Cr Mo 3

**Chemical Composition of  
Welding Wire % (Typical)**

Ni	C	Cr	Mn	Fe	Mo	Nb
Rest	0.02	22.0	0.20	1.0	9.0	3.50

**Mechanical Properties**

Yield Strength (N/mm <sup>2</sup> )	Tensile Strength (N/mm <sup>2</sup> )	Impact Strength		Elongation ((L <sub>0</sub> =5d <sub>0</sub> ) (%))
		(ISO-V/+20°C)	(ISO-V/-196°C)	
540	800	140 J	75 J	38

**Typical Base Material Grades**

• 1.4583 X10CrNiMoNb18-12, 1.4876 X10NiCrAlTi32-20, 1.4529 X1NiCrMoCuN25-20-7, X2CrNiMoCuN20-18-6, 2.4641 NiCr 21 Mo 6 Cu, 2.4856 NiCr 22 Mo 9 Nb, 2.4858 NiCr 21 Mo, 2.4816 NiCr 15 Fe • Welding of Joining: P265GH, P285NH, P295GH, 16Mo3, S355N, X8Ni9 ((Inconel 600), ((Inconel 625), ((Incoloy 800)

**Features and Applications**

• Applicability in joint welding of steels with high Mo-contents to steels with Ni-based alloy steels, joint welding of different types of steels, and in welding of low-alloyed problematic steels  
 • Suitability for use in manufacture processes of pressure vessels with service temperatures between -196°C and + 550°C • High resistance to creep, to high temperatures, and to low temperatures (cryogenic applications) • Resistance to formation of oxide layers at temperatures up to 1200°C • Loss of elasticity at temperatures between 600°C - 800°C. • High strength against hot cracking. • General tendency towards diffusion of carbon at high temperatures or towards heat treatments of different materials. • Very high resistance to stress corrosion and to pitting corrosion (PREN 52). • Resistance to thermal shocks • Austenitic-structured stainless material with low coefficient of thermal expansion. • Very excellent performance in TIG welding.  
 • Use of Ar or Ar+He mix as shielding gas.

**Welding Positions**

**Current Type**

MIG D.C. (+) / TIG D.C.(-)

**Operating Data**

Product Code	Diameter x Length (mm) / (inch)	Package Weight (Kg)
6031100099	1.00 / 0,040"	15
6031100298	1.20 / 0,047"	15
6031100101	1.6 x 1000 / 1/16 x 39"	5
6031100299	2.0 x 1000 / 5/64 x 39"	5
6031100300	2.4 x 1000 / 3/32 x 39"	5

Approvals: GOST-R, SEPRO

**Standards**

TS EN ISO 18274	: S Ni 6082
EN ISO 18274	: S Ni 6082
AWS A5.14	: ER NiCr-3

**Chemical Composition of  
Welding Wire % (Typical)**

Ni	C	Cr	Mn	Fe	Nb
Rest	0.02	20.0	3.0	4.0	2.5

**Mechanical Properties**

Yield Strength (N/mm <sup>2</sup> )	Tensile Strength (N/mm <sup>2</sup> )	Impact Strength (ISO-V/+20°C)	Elongation ((L <sub>0</sub> =5d <sub>0</sub> ) (%))
400	650	150 J	40

**Typical Base Material Grades**

- 2.4816 - 2.4817 - 2.4806 - Alloy 600 - 1.4876 - 1.5662 - 1.5680,2.4951,2.4961,1.4981, 1.4985

**Features and Applications**

- Especially in welding of Nickel based alloys high temperature and creep resistant steels, problematic steels and dissimilar joints
- Weld metal mechanical properties are resistant to heat treating
- Shielding gas: Ar (MIG and TIG)

**Welding Positions**

**Welding Electrode**

GeKaTec ANTI-CRACK 7015

**Current Type**

MIG D.C. (+) / TIG D.C.(-)

**Operating Data**

Product Code	Diameter x Length (mm) / (inch)	Package Weight (Kg)
6031100301	1.00 / 0,040"	15
6031100302	1.20 / 0,047"	15
6031100106	1.6 x 1000 / 1/16 x 39"	5
6031100107	2.0 x 1000 / 5/64 x 39"	5
6031100303	2.4 x 1000 / 3/32 x 39"	5

Approvals: GOST-R, SEPRO



**Standards**
**Chemical Composition of  
Welding Wire % (Typical)**

TS 9463 EN ISO 1071 : S C NiFe-1
EN ISO 1071 : S C NiFe-1

C	Cu	Mn	Fe	Ni
0.05	0.35	0.60	44-46	min.53

**Mechanical Properties**

Yield Strength (N/mm <sup>2</sup> )	Tensile Strength (N/mm <sup>2</sup> )	Hardness (HB)	Elongation ((L <sub>0</sub> =5d <sub>0</sub> ) (%))
min. 290	min. 425	200	min. 8

**Features and Applications**

- NiFe SG MIG-TIG wire is used for joining and build-up of all types of cast irons (gray, tempered, sfero) and cast iron to non alloyed and high alloyed steels, copper and nickel based alloys
- Especially it is suitable for building up cast moulds in automotive industry and iron and steel sector
- Machinability is easy and weld metal surface must be clean and pre-heat at 150°C - 250°C
- Shielding gas: Ar (MIG and TIG)

**Welding Positions**

**Welding Electrode**

GeKaTec Fe-CAST / GeKaTec Fe-CAST HD

**Current Type**

MIG D.C. (+) / TIG D.C.(-)

**Operating Data**

Product Code	Diameter x Length (mm) / (inch)	Package Weight (Kg)
6031100308	1.20 / 0,047"	15
6031100309	1.6 x 1000 / 1/16 x 39"	5
6031100310	2.0 x 1000 / 5/64 x 39"	5
6031100311	2.4 x 1000 / 3/32 x 39"	5

**Approvals:** GOST-R, CE, SEPRO

**Standards**
**Chemical Composition of  
Welding Wire % (Typical)**

AWS A5.16 : ER Ti 2

C	Fe	H	Ti
<0.03	<0.025	<0.008	Rest

**Mechanical Properties**

Yield Strength (N/mm <sup>2</sup> )	Tensile Strength (N/mm <sup>2</sup> )	Hardness (HB)	Elongation ((L <sub>0</sub> =5d <sub>0</sub> ) (%))
275	395 - 540	180	20

**Features and Applications**

- Suitability for uses in TIG welding of pure Titanium and of Titanium alloys
- Medium-strength wire with high percentage of elongation
- Requirement of pure Ar as shielding gas in TIG welding

**Welding Positions**

**Current Type**

TIG D.C.(-)

**Operating Data**

Product Code	Diameter x Length (mm) / (inch)		Package Weight (Kg)	Package Type
6031100323	2.00 x 1000	5/64 x 39"	5	Carton Box

**Approvals:** GOST-R, SEPRO

### Standards

DIN 8555 : MSG 1-GZ-250

### Chemical Composition of Welding Wire % (Typical)

C	Si	Mn	Cr	Mo
0.09	0.55	1.00	3.00	1.00

### Mechanical Properties

**Hardness** (after working)  
(HRC)

22 - 27

### Features and Applications

- Cr-Mo alloyed steels (1.5%-0.5%) resistant to high temperature, wear, pressure and shocks
- Good resistance to cracking and to the attack of sulphures agents
- Guide rollers, excavators, screw conveyers, gears, moulds, rolling surfaces, etc
- Before the application of welding, it is recommended pre-heating of 300°C
- If necessary , post- weld stress relief should be made at 690°C
- Shielding Gas: Ar+CO<sub>2</sub> mix gases can be used

### Welding Positions



### Current Type

MAG D.C.(+)

### Operating Data

Product Code	Diameter x Length (mm) / (inch)	Weight (Kg)	Package Type
6031100313	1.20      0.047"	15	BS 300 Spool

Approvals: SEPRO, GOST-R

**Standards**

DIN 8555 : MSG 5-GZ-350

**Chemical Composition of  
Welding Wire % (Typical)**

C	Si	Mn	Cr	Mo
0.50	0.55	0.90	6.00	0.90

**Mechanical Properties**
**Hardness (After Working)**  
 (HRC)

36 - 40

**Features and Applications**

- Cr-Mo alloyed steels (2.5%-1.0%) resistant to high temperature, wear, pressure and shocks
- Good resistance to cracking and to the attack of sulphures agents
- Guide rollers, excavators, screw conveyers, gears, moulds, rolling surfaces, etc
- Before the application of welding , it is recommended pre-heating of 200°C
- If necessary , post- weld stress relief should be made at 660°C
- Shielding Gas: Ar+CO<sub>2</sub> mix gases can be used

**Welding Positions**

**Current Type**

MAG D.C.(+)

**Operating Data**

Product Code	Diameter x Length (mm) / (inch)	Weight (Kg)	Package Type
6031100314	1.20    0.047"	15	BS 300 Spool

**Approvals:** SEPRO, GOST-R

**Standards**

EN 14700	: S Fe 2
DIN 8555	: MSG / WSG 2-GZ-50

**Chemical Composition of  
Welding Wire % (Typical)**

C	Si	Mn	Cr	Ti
1.10	0.50	1.90	1.80	0.20

**Mechanical Properties**

**Hardness** (after working)  
(HRC)

47 - 52

**Features and Applications**

- Excellent resistance to wear and shocks
- Parts of excavators, mordan bucket theeth, drilling and percussion bits, shaping machines, screw conveyors, crushers, moulds, guide rollers, etc
- Before the application of welding , it is recommended pre-heating of 300°C
- It necessary , post- weld stress relief should be made at 690°C
- Shielding Gas: MAG; Ar+CO<sub>2</sub> mix gases & TIG; % 100 Ar gas can be used

**Welding Positions**

**Current Type**

MAG D.C.(+) / TIG D.C. (-)

**Operating Data**

Product Code	Diameter x Length		Weight (Kg)	Package Type
	(mm)	(inch)		
6031100315	1.20	0.047"	15	BS 300 Spool
6031100316	2.00 x 1000	5/64 x 39"	5	Carton Box

Approvals: SEPRO, GOST-R, CE

**Standards**

TS EN 14700	: S Fe8
EN 14700	: S Fe8
DIN 8555	: MSG G GZ 60

**Chemical Composition of  
Welding Wire % (Typical)**

C	Mn	Cr	Si
0.45	0.040	9.20	3.0

**Mechanical Properties**

Hardness			
(After Working)	Softening (800°C)	1000°C - Oil	Single Pass in Unalloyed Steel
55-60 HRC	~250 HB	62 HRC	~53 HRC

**Features and Applications**

- It is used in welding of alloyed and non alloyed metal parts of mining and earth machines, pulsed run drilling and crushing machines
- Build up cutting tool edges and hard manganese steels cover pass
- It can be machined by grinding
- Shielding gas : MAG; Ar+CO<sub>2</sub> mix gases and TIG; %100 Ar gas can be used

**Welding Positions**

**Welding Electrode**

GeKaTec FAZER 55 HD

**Current Type**

MAG D.C. (+) / TIGD.C.(-)

**Operating Data**

Product Code	Diameter x Length		Package Weight (Kg)
	(mm)	(inch)	
6031100317	1.00	0.040"	15
6031100318	1.20	0.047"	15
6031100319	2.00 x 1000	5/64 x 39"	5
6031100320	2.40 x 1000	3/32 x 39"	5

**Approvals:** GOST-R, CE, SEPRO

### Standards

DIN 8555	: MSG 3-GZ-40-PT
	: WSG 3-GZ-40-PT

### Chemical Composition of Welding Wire % (Typical)

C	Si	Cr	Mo	Mn
0.01	0.40	6.00	3.00	0.60

### Mechanical Properties

**Hardness** (after working)  
(HRC)

37 - 42

### Typical Base Material Grades

- 1.2367-1.2365-1.274-1.2344-1.2343-1.2083

### Features and Applications

- Used in build up materials exposed to impact, pressure and abrasion, hot work tool steels for filler metals
- Application range is forging dies, hammers, v-beds, cast steels, continuous casting rollers etc
- The weld metal has wear resistance and high toughness at high temperatures
- 400°C pre-heat temperature must be done before welding
- Shielding gas: MAG: Ar+CO<sub>2</sub>  
TIG: Ar

### Welding Positions



### Welding Electrode

GeKaTec THERMO RESIST

### Current Type

MAG D.C.(+) / TIG D.C. (-)

### Operating Data

Product Code	Diameter x Length (mm) / (inch)		Package Weight (Kg)	
			MAG	TIG
6031100324	1.00	0.039"	BS 300 15 Kg	Carton Box 5 Kg
6031100325	1.20	0.047"		
6031100326	1.6 x 1000	1/16 x 39"		
6031100327	2.0 x 1000	5/64 x 39"		
6031100328	2.4 x 1000	3/32 x 39"		

Approvals: GOST-R , SEPRO

**Standards**

DIN 8555	: MSG 3-GZ-50-ST
	: WSG 3-GZ-50-ST

**Chemical Composition of  
Welding Wire % (Typical)**

C	Si	Mn	Cr	Ti	Mo
0.30	0.50	0.70	5.00	0.70	3.60

**Mechanical Properties**

**Hardness** (as welded)  
(HRC)

45 - 48

**Typical Base Material Grades**

- 1.2367-1.2365-1.274-1.2344-1.2343-1.2083

**Features and Applications**

- Generally are used in build-up for hot work tool steels
- Application areas forging dies, gravures, hot cutting tools, de-burring tools, punches, aluminum casting moulds, repair of 1.2344 hot work tool steels
- Used in steel casting and mold applications with 45-48 HRC strength of hardfacing welds
- Weld metal has wear and impact resistance at high temperatures
- 400°C pre-heat must be done before welding
- It has wear and impact resistance at high temperatures
- Shielding gas: MAG: Ar+CO<sub>2</sub>  
TIG: Ar

**Welding Positions**

**Welding Electrode**

GeKaTec THERMO DUR

**Current Type**

MAG D.C.(+) / TIG D.C. (-)

**Operating Data**

Product Code	Diameter x Length (mm) / (inch)		Package Weight (Kg)	
			MAG	TIG
6031100143	1.00	0.040"	BS 300 15 Kg	Carton Box 5 Kg
6031100329	1.20	0.047"		
6031100330	1.6 x 1000	1/16 x 39"		
6031100331	2.0 x 1000	5/64 x 39"		
6031100332	2.4 x 1000	3/32 x 39"		

**Approvals:** GOST-R , SEPRO



**Standards**

DIN 8555	: MSG 3-GZ-55-T
	: WSG 3-GZ-55-T

**Chemical Composition of  
Welding Wire % (Typical)**

C	Si	Mn	Cr	Mo
0.35	0.40	1.00	7.00	1.10

**Mechanical Properties**

<b>Hardness (as welded)</b> (HRC)
53 -58

**Typical Base Material Grades**

- 1.2510-1.2363-1.2721-1.2379-1.2842-1.1730-1.2990

**Features and Applications**

- Application areas are cold and hot work tool steels which are used in machine parts, cold and hot cutting blades, extrusion dies, rollers, steel castings and moulds
- It is hard facing wire which has high abrasion resistance and keep hardness at high temperatures
- 400°C pre-heat temperature must be done before welding if it is needed, stress relieving must be done at 550°C after welding
- Shielding gas: MAG: Ar+CO<sub>2</sub>  
TIG: Ar

**Welding Positions**

**Welding Electrode**

GeKaTec TOOL 58 S

**Current Type**

MAG D.C.(+) / TIG D.C. (-)

**Operating Data**

Product Code	Diameter x Length (mm) / (inch)		Package Weight (Kg)	
			MAG	TIG
6031100148	1.00	0.040"	BS 300 15 Kg	Carton Box 5 Kg
6031100333	1.20	0.047"		
6031100334	1.6 x 1000	1/16 x 39"		
6031100389	2.0 x 1000	5/64 x 39"		
6031100335	2.4 x 1000	3/32 x 39"		

Approvals: GOST-R, SEPRO

### Standards

TS EN 14700	: T Fe8
EN 14700	: T Fe8
DIN 8555	: TIG 6-GF-55-T

### Chemical Composition of Welding Wire % (Typical)

C	Si	Mn	Cr	Mo
0.55	0.7	1.0	7.0	2.0

### Mechanical Properties

<b>Hardness (as welded)</b> (HRC)
53 -56

### Features and Applications

- It is hardfacing TIG wire which has high abrasion resistance and keep hardness at high temperatures
- Application range is cold and hot work tool steels which are used in machine parts, cold and hot cutting blades, extrusion dies, rollers, steel casings, moulds, tools and metal-to-metal friction applications
- Weld metal is machinable by grinding
- It is recommended that pre-heating at 400°C before welding and very slow cooling after welding
- If necessary, it is recommended the stress relief annealing at 550°C after welding
- Shielding Gas: Argon

### Welding Positions



### Current Type

TIG D.C. (-)

### Operating Data

Product Code	Diameter x Length (mm) / (inch)	Package Weight (Kg)	Package Type
3030600001	2.40 x 1000 / 3/32 x 39"	5	Carton Box

Approvals: GOST-R, SEPRO, CE

### Standards

TS EN 14700	: T Fe4
EN 14700	: T Fe4
DIN 8555	: TIG 3-GF-60-T

### Chemical Composition of Welding Wire % (Typical)

C	Si	Mn	Cr	Mo	W
0.55	0.5	0.4	4.0	8.0	1.60

### Mechanical Properties

<b>Hardness</b> (as welded) (HRC)
56 - 60

### Features and Applications

- It is hardfacing TIG wire which has high abrasion resistance and keep hardness at high temperatures
- Application range is cold and hot work tool steels which are used in machine parts, cold and hot cutting blades, extrusion dies, rollers, steel casings, moulds, tools and metal-to-metal friction applications
- Weld metal is machinable by grinding
- It is recommended that pre-heating at 400°C before welding and very slow cooling after welding
- If necessary, it is recommended the stress relief annealing at 550°C after welding
- Shielding Gas : Argon

### Welding Positions



### Current Type

TIG D.C. (-)

### Operating Data

Product Code	Diameter x Length (mm) / (inch)	Package Weight (Kg)	Package Type
3030600002	2.40 x 1000 / 3/32 x 39"	5	Carton Box

Approvals: CE , SEPRO

**Standards**

DIN 8555 : M / WSG 3-GZ-60-T

**Chemical Composition of  
Welding Wire % (Typical)**

C	Si	Mn	Cr	Mo	V	W
0.37	1.1	0.4	5.2	1.4	0.35	1.3

**Mechanical Properties**

**Hardness** (after welding)  
(HRC)

57 - 60

**Features and Applications**

- High adhesive wear and impact-resistant, cold work tool steels require filling from strength, high temperature, abrasion and impact resistance that requires welding of hot-work tool steels are used
- The construction of non-alloy steel cutting edge, cutting and stripping tool steels used in the regions
- Tool steels can be given 300°C to 400°C pre-heating source
- Shielding Gas : MAG: Ar+CO<sub>2</sub> mix gases  
TIG: Ar

**Welding Positions**

**Welding Electrode**

GeKaTec TOOL 58 S

**Current Type**

MAG D.C.(+) / TIG D.C.(-)

**Operating Data**

Product Code	Diameter x Length		Package Weight (Kg)
	(mm) / (inch)		
6031100358	1.20	0.047"	15
6031100359	1.6 x 1000	1/16 x 39"	5
6031100360	2.0 x 1000	5/64 x 39"	5
6031100153	2.4 x 1000	3/32 x 39"	5

**Approvals:** GOST-R , SEPRO

**Standards**

DIN 8555 : M / WSG 4-60-S

**Chemical Composition of  
Welding Wire % (Typical)**

C	Si	Mn	Cr	Mo	V	W
1.0	0.3	0.3	4.0	8.3	1.9	1.8

**Mechanical Properties**
**Hardness** (after welding)  
(HRC)

60 - 62

**Typical Base Material Grades**

- 1.2436-1.3241-1.3344-1.3207

**Features and Applications**

- Application range is production of cutting edges of mild steels, hard facing of cutting edges of cutting dies
- It is hard facing wire
- Weld metal structure is similar to high speed steel and has abrasion, wear and pressure resistance
- Shielding gas: TIG : Ar

**Welding Positions**

**Welding Electrode**

GeKaTec TOOL 60

**Current Type**

TIG D.C.(-)

**Operating Data**

Product Code	Diameter x Length		Package Weight (Kg)
	(mm) / (inch)		
6031100336	1.6 x 1000	1/16 x 39"	5
6031100337	2.0 x 1000	5/64 x 39"	5
6031100338	2.4 x 1000	3/32 x 39"	5

**Approvals:** GOST-R , SEPRO

**COBALT 6 TIG** AWS A521: ER.CoCr-A

This wire is suitable for hardfacing of parts subjected to a combination of pressure, impact, abrasion, corrosion, erosion, cavitation and high heat up to 900°C, such as tight surfaces of fittings, valve seats and cones for combustion engines, gliding surfaces of fittings, valve seats and cones for combustion engines, gliding surfaces of fittings, valve seats and cones for combustion engines, gliding surfaces metal to metal highly stressed hot working tools without thermal shock, milling, mixing and drilling tools. Excellent gliding characteristics, very good polishability, high toughness, non magnetic. Machinable by grinding and with tungsten carbide tools.

**Chemical composition %:** C:1.1 / Cr:28 / W:4.0 / Co:Rest

**Hardness:** TIG:40HRC Oxy-acetylene: 40 HRC

**Dimensions:** 3.20 - 4.0 - 5.0 x 1000mm

**Welding Electrode :** GeKaTec COBALT 6

**Flux Cored Wire :** GeKa HARDCOR COBALT 6

**COBALT 12 TIG** AWS A5.21 : ER.CoCr-B

This wire is suitable for highly wear resistant hardfacing of parts subjected to a combination of hardfacing, abrasion, corrosion, erosion, cavitation and high heat up to 900°C, such as a running sealing and gliding faces of fittings and pumps, valve seats and cones for combustion engines tools for the wood, paper and plastic industry, gliding surfaces metal to metal, milling, mixing and drilling tools, heavy duty hot working tools without thermal shock. Excellent gliding characteristics very good polishability high toughness, non magnetic. Machinable by grinding and with tungsten carbide tools.

**Chemical Composition %C:** 1.4,Cr: 29, W:8, Co:Rest

**Hardness:** TIG :47 HRC Oxy-acetylene: 48 HRC

**Dimensions:** 3.20 - 4.0-5.0x 1000 mm

**Welding Electrode :** GeKaTec COBALT 12

**Flux CoredWire :** GeKa HARDCOR COBALT 12

**COBALT 1 TIG** AWSN521: E R.Co Cr-C

This wire is suitable for highly wear resistant hardfacing of parts subjected to a combination of abrasion, corrosion and high heat up to 900°C, such as working parts in the chemical industry running and sealing faces of fittings, valve seats and cones for combustion engines, cutting shearing tools, milling, mixing, drilling tools, heavy-duty hot working tools without thermal shock Excellent gliding characteristics, good polishability, slightly, magnetic. Mach nable by grinding and with tungsten carbide tools.

**Chemical Composition %C:** 2.5,Cr:30 , W:12, Co:Rest

**Hardness:** TIG:54HRC Oxy-acetylene: 53 HRC

**Dimensions:** 3.20 - 4.0-5.0 X 1000mm

**Welding Electrode :** GeKaTec COBALT 1

**Flux CoredWire :** GeKa HARDCOR COBALT 1

**Operating Data**

Product	Product Code	Diameter (mm)	Diameter (inch)	Package Weight (Kg)
COBALT6TIG	6031100133	3.2 x 1000	1/8 x 39"	10
COBALT6TIG	6031100134	4.0 x 1000	5/32 x 39"	10
COBALT 12TIG	6031100135	3.2 x 1000	1/8 x 39"	10
COBALT 12TIG	6031100136	4.0 x 1000	5/32 x 39"	10
COBALT 1 TIG	6031100321	3.2 x 1000	1/8 x 39"	10
COBALT 1 TIG	6031100322	4.0 x 1000	5/32 x 39"	10

**Approvals:** GOST-R , SEPRO

**Applications of Tungsten Electrodes**

Product Name	AWS Norm / Colour	Current Type	Applications
GeKaTec TUNGSTEN Red	EWTh-2	DC	<ul style="list-style-type: none"> <li>- Unalloyed &amp; High alloyed steels</li> <li>- Titanium alloys</li> <li>- Nickel alloys</li> <li>- Copper alloys</li> </ul>
GeKaTec TUNGSTEN Green	EWP	AC	<ul style="list-style-type: none"> <li>- Aluminium alloys</li> <li>- Magnesium alloys</li> </ul>
GeKaTec TUNGSTEN Gold	EWLa-1.5	AC / DC	<ul style="list-style-type: none"> <li>- Non-alloyed &amp; low alloyed steels</li> <li>- Stainless Steels</li> <li>- Aluminium Alloys</li> <li>- Magnesium Alloys</li> <li>- Titanium Alloys</li> <li>- Nickel Alloys</li> <li>- Copper Alloys</li> </ul>
GeKaTec TUNGSTEN Blue	EWLa-2	AC / DC	<ul style="list-style-type: none"> <li>- Non-alloyed &amp; low alloyed steels</li> <li>- Stainless Steels</li> <li>- Aluminium Alloys</li> <li>- Magnesium Alloys</li> <li>- Titanium Alloys</li> <li>- Nickel Alloys</li> <li>- Copper Alloys</li> </ul>
GeKaTec TUNGSTEN Grey	EWCe-2	AC / DC	<ul style="list-style-type: none"> <li>- Unalloyed &amp; High alloyed steels</li> <li>- Titanium alloys</li> <li>- Nickel alloys</li> <li>- Copper alloys</li> <li>- Aluminium alloys</li> <li>- Stainless Steels</li> <li>- Magnesium Alloys</li> </ul>

**Operating Data**

<b>Product</b>	<b>Product Code</b>	<b>Diameter x Length (mm)</b>	<b>Diameter x Length (inch)</b>	<b>Pcs. / Package</b>
Tungsten Red	6051500032	1.6 x 175	1/16 x 7"	10
Tungsten Red	6051500033	2.0 x 175	5/64 x 7"	10
Tungsten Red	6051500034	2.4 x 175	3/32 x 7"	10
Tungsten Red	6051500035	3.2 x 175	1/8 x 7"	10
Tungsten Red	6051500049	4.0 x 175	5/32 x 7"	5
Tungsten Green	6051500036	1.6 x 175	1/16 x 7"	10
Tungsten Green	6051500037	2.0 x 175	5/64 x 7"	10
Tungsten Green	6051500038	2.4 x 175	3/32 x 7"	10
Tungsten Green	6051500039	3.2 x 175	1/8 x 7"	10
Tungsten Green	6051500040	4.0 x 175	5/32 x 7"	5
Tungsten Gold	6051500050	1.6 x 175	1/16 x 7"	10
Tungsten Gold	6051500044	2.0 x 175	5/64 x 7"	10
Tungsten Gold	6051500045	2.4 x 175	3/32 x 7"	10
Tungsten Gold	6051500051	3.2 x 175	1/8 x 7"	10
Tungsten Gold	6051500052	4.0 x 175	5/32 x 7"	5
Tungsten Blue	6051500022	1.6 x 175	1/16 x 7"	10
Tungsten Blue	6051500042	2.0 x 175	5/64 x 7"	10
Tungsten Blue	6051500024	2.4 x 175	3/32 x 7"	10
Tungsten Blue	6051500043	3.2 x 175	1/8 x 7"	10
Tungsten Blue	6051500055	4.0 x 175	5/32 x 7"	5
Tungsten Grey	6051500041	1.6 x 175	1/16 x 7"	10
Tungsten Grey	6051500048	2.4 x 175	3/32 x 7"	10
Tungsten Grey	6051500053	3.2 x 175	1/8 x 7"	10
Tungsten Grey	6051500054	4.0 x 175	5/32 x 7"	5



**Standards**

TS EN 14700	: T Fe1
EN 14700	: T Fe1
DIN 8555	: MF 1-GF-300 P

**Chemical Composition of  
Weld Metal (Typical)**

C	Si	Mn	Cr	Fe
0.13	0.30	1.00	2.0	Rest

**Mechanical Properties**

<b>Hardness</b> (as welded) (HB)
300

**Typical Base Material Grades**

- Steel mill rolls, shafts, steel hammers, gear teeth, shovel pads, conveyor chains, crane wheels, rail track changers, gear wheels, sprockets as well as carrying rollers

**Features and Applications**

- Suitable for uses in buffer-layer welding before hardfacing applications on parts exposed to high impact/pressure/wear. Alloy group is low alloy steel. Low alloy wire designed for build-up on carbon steels. Slag removal is very good. GeKaTec HARDCOR 300 G has excellent compressive strength and resistance to cracking. Machinability is very good. Requirement of cleaning of base material's surface and of heating of the base material at approximately 150°C

**Welding Positions**

**Operating Data**

Diameter (mm)	Welding Current (A)	Voltage (V)	Stick-out (mm)
1.20	170 - 190	17.0 - 19.0	25.0 - 30.0

**Current Type**

FCAW / D.C. (+)

**Operating Data**

Product Code	Diameter x Length (mm) / (inch)		Package Weight (Kg)
3030500004	1.20	0.047"	15

**Approvals:** GOST-R, CE, SEPRO

**Standards**

TS EN 14700	: T Fe1
EN 14700	: T Fe1
DIN 8555	: MF 1-GF-300 P

**Chemical Composition of  
Weld Metal (Typical)**

C	Si	Mn	Cr	Fe
0.13	0.30	2.50	1.25	Rest

**Mechanical Properties**

<b>Hardness</b> (as welded) (HB)
300

**Typical Base Material Grades**

- Steel mill rolls, shafts, steel hammers, gear teeth , shovel pads, conveyor chains, crane wheels, rail track changers, gear wheels, sprockets as well as carrying rollers

**Features and Applications**

- Suitable for uses in buffer-layer welding before hardfacing applications on parts exposed to high impact/pressure/wear. Alloy group is low alloy steel. Low alloy wire designed for build-up on carbon steels. Slag removal is very good. GeKaTec HARDCOR 300 0 has excellent compressive strength and resistance to cracking. Machinability is very good. Requirement of cleaning of base material's surface and of heating of the base material at approximately 150°C. Build up is generally unlimited with proper heat treatment procedures. Shielding Gas: Open Arc

**Welding Positions**

**Operating Data**

Diameter (mm)	Welding Current (A)	Voltage (V)	Stick-out (mm)
1.60	180 - 200	26.0 - 30.0	25.0 - 30.0
2.80	300 - 500	23.0 - 31.0	25.0 - 30.0

**Current Type**

FCAW / D.C. (+)

**Operating Data**

Product Code	Diameter x Length (mm) / (inch)		Package Weight (Kg)
6031100376	1.60	1/16	15
6031100364	2.80	7/64	25

**Approvals:** GOST-R, CE, SEPRO

**Standards**

TS EN 14700	: T Fe7
EN 14700	: T Fe7
DIN 8555	: MF 5-45-PRT

**Chemical Composition of  
Weld Metal (Typical)**

C	Si	Mn	Cr	Ni	Mo	Nb	V	Fe
0.14	1.0	1.0	13.0	3.5	1.2	0.2	0.1	Rest

**Mechanical Properties**

<b>Hardness</b> (as welded) (HRC)
43 - 45

**Typical Base Material Grades**

- Casting rollers particularly at iron-steel production plants, relays, valves, valves used in gas/water/steam environments, flanges, compressors,

**Features and Applications**

- Suitability for use in welding of martencitic-ferritic materials used as tools for rolling, forging and steel casting operations
- Welding bead's hardness value of approximately 40 HRC, which the weld maintains at high temperatures
- High resistance to corrosion

**Welding Positions**

**Operating Data**

Diameter (mm)	Welding Current (A)	Voltage (V)	Stick-out (mm)
1.60	150 - 250	20 - 31	20 - 25

**Current Type**

FCAW / D.C. (+)

**Operating Data**

Product Code	Diameter x Length (mm) / (inch)		Package Weight (Kg)
6031100369	1.60	0.062"	15

**Approvals:** GOST-R, CE, SEPRO

### Standards

TS EN 14700	: T Fe7
EN 14700	: T Fe7
TS EN ISO 17633-A	: T 13 4 M M 3
EN ISO 17633-A	: T 13 4 M M 3
AWS A5 .22	: E C 410 NiMo (mod.)

### Chemical Composition of Weld Metal (Typical)

C	Si	Mn	Cr	Ni	Mo
0.05	0.35	0.70	12.0	4.0	0.60

### Mechanical Properties

<b>Hardness</b> (as welded) (HB)
400

### Typical Base Material Grades

- Steel mill rolls, rollers, pumps and 410 stainless valves.

### Features and Applications

- Cr-Ni alloyed metal flux cored wire for hardfacing applications
- Can be used joint welding
- Shielding gas: M21

### Welding Positions



### Operating Data

Diameter (mm)	Welding Current (A)	Voltage (V)	Stick-out (mm)
1.60	180 - 210	26.0 - 31.0	25.0 - 30.0

### Current Type

FCAW / D.C. (+)

### Operating Data

Product Code	Diameter x Length (mm) / (inch)		Package Weight (Kg)
3030500008	1.60	0.062"	15

Approvals: GOST-R, CE, SEPRO

**Standards**

TS EN 14700	: T Fe 6
EN 14700	: T Fe 6
DIN 8555	: MF 6-GF-60 GP

**Chemical Composition of  
Weld Metal (Typical)**

C	Si	Mn	Cr	Fe
0.40	0.70	0.60	9.0	Rest

**Mechanical Properties**

<b>Hardness (as welded)</b> (HB)
600

**Typical Base Material Grades**

- Hardfacing of parts of earth and mineral mining machines, impact drilling and crushing devices, guide springs, edges of cutting tools, hard bucket edges and teeth , all of which are made of alloyed or unalloyed steels, as well as in other materials required to have high resistance to wear, debarking knives, agricultural tillage tools, earth moving bucket lips

**Features and Applications**

- High resistance to wear and to impact
- Alloy group is martensitic tool steel
- Weld metals of high hardness and high toughness
- Machinability of metal through grinding only
- It is excellent choice for components that are required to maintain a sharp edge
- Shielding Gas: CO<sub>2</sub>

**Welding Positions**

**Operating Data**

Diameter (mm)	Welding Current (A)	Voltage (V)	Stick-out (mm)
1.20	140 - 200	26.0 - 30.0	30.0 - 35.0
1.60	180 - 200	26.0 - 30.0	30.0 - 35.0

**Current Type**

FCAW / D.C. (+)

**Operating Data**

Product Code	Diameter x Length (mm) / (inch)		Package Weight (Kg)
3030500010	1.20	0.047"	15
3030500011	1.60	0.062"	15

**Approvals:** GOST-R, CE, SEPRO

## Standards

DIN 8555 : MF 6-GF-60-GP

## Chemical Composition of Weld Metal (Typical)

C	Si	Mn	Cr	Fe
0.40	2.00	0.60	9.0	Rest

## Mechanical Properties

**Hardness** (as welded)  
(HB)

600

## Typical Base Material Grades

- Hardfacing of parts of earth and mineral mining machines, impact drilling and crushing devices, guide springs, edges of cutting tools, hard bucket edges and teeth, all of which are made of alloyed or unalloyed steels, as well as in other materials required to have high resistance to wear, debarking knives, agricultural tillage tools, earth moving bucket lips.

## Features and Applications

- HARDCOR 600 M G is metal cored flux-cored wire for hardfacing
- High resistance to wear and to impact
- Alloy group is martensitic tool steel
- Weld metals of high hardness and high toughness
- Machinability of metal through grinding only
- It is excellent choice for components that are required to maintain a sharp edge
- Shielding Gas: CO<sub>2</sub> (M21)

## Welding Positions



## Operating Data

Diameter (mm)	Welding Current (A)	Voltage (V)	Stick-out (mm)
1.20	170 - 200	27.0 - 30.0	20.0 - 25.0
1.60	180 - 220	26.0 - 31.0	20.0 - 35.0

## Current Type

FCAW / D.C. (+)

## Operating Data

Product Code	Diameter x Length (mm) / (inch)		Package Weight (Kg)
3030500030	1.20	0.047"	15
3030500031	1.60	0.062"	15

Approvals: GOST-R, CE, SEPRO

**Standards**

TS EN 14700	: T Fe 6
EN 14700	: T Fe 6
DIN 8555	: MF 6 GF 60 GR

**Chemical Composition of  
Weld Metal (Typical)**

C	Si	Mn	Cr	Mo	Nb
0.60	0.60	0.65	8.2	1.2	0.15

**Mechanical Properties**

<b>Hardness (as welded) (HRC)</b>
56

**Typical Base Material Grades**

- Hardfacing of parts of earth and mineral mining machines, impactdrilling and crushing devices, guide springs, edges of cutting tools, hard bucket edges and teeth, all of which are made of alloyed or unalloyed steels, as well as in order materials required to have high resistance to wear, debraking knives, agricultural tillage tools, earth moving bucket lips

**Features and Applications**

- Used in hardfacing welding of pieces exposed to high impact and abrasion wear
- Weld metal microstructure is martensitic and has excellent resistance to friction metal to metal
- This wire can also be used as a filling for cutting edge welding
- Cracking does not observed
- Because of the rutile character there is no spatter during welding, weld metal seam is perfect
- Shielding Gas : CO<sub>2</sub>

**Welding Positions**

**Operating Data**

Diameter (mm)	Welding Current (A)	Voltage (V)	Stick-out (mm)
1.20	170 - 200	27.0 - 30.0	25.0 - 30.0
1.60	180 - 220	26.0 - 31.0	25.0 - 30.0

**Current Type**

FCAW / D.C.(+)

**Operating Data**

Product Code	Diameter x Length (mm) / (inch)		Package Weight (Kg)
3030500018	1.20	0.047"	15
3030500019	1.60	0.062"	15

Approvals: CE, SEPRO

**Standards**

DIN 8555 : MF 6-GF-60-GP

**Chemical Composition of  
Weld Metal (Typical)**

C	Si	Mn	Cr	Fe
0.80	1.20	1.40	8.0	Rest

**Mechanical Properties**
**Hardness (as welded)**  
 (HRC)

58

**Typical Base Material Grades**

- Hardfacing of parts of earth and mineral mining machines, impact drilling and crushing devices, guide springs, edges of cutting tools, hard bucket edges and teeth, all of which are made of alloyed or unalloyed steels, as well as in other materials required to have high resistance to wear, debarking knives, agricultural tillage tools, earth moving bucket lips

**Features and Applications**

- High resistance to wear and to impact. Alloy group is martensitic tool steel
- Weld metals of high hardness and high toughness
- Machinability of metal through grinding only
- It is excellent choice for components that are required to maintain a sharp edge
- 58 HRC offers high hardness with good balance between abrasion and impact resistance
- Shielding Gas : Open Arc

**Welding Positions**

**Operating Data**

Diameter (mm)	Welding Current (A)	Voltage (V)	Stick-out (mm)
1.60	180 - 200	26.0 - 30.0	20.0 - 25.0
2.80	325 - 450	26.0 - 30.0	20.0 - 25.0

**Current Type**

FCAW / D.C. (+)

**Operating Data**

Product Code	Diameter x Length (mm) / (inch)		Package Weight (Kg)
6031100377	1.60	1/16	15
6031100378	2.80	7/64	25

**Approvals:** GOST-R, SEPRO



**Standards**

TS EN 14700	: T Fe9
EN 14700	: T Fe9
DIN 8555	: - MF 7-GF-200 KP

**Chemical Composition of  
Weld Metal (Typical)**

C	Si	Mn	Cr	Fe
0.40	0.75	15.0	15.0	Rest

**Mechanical Properties**

Hardness	
(As Welded) (HRC)	(After Working) (HRC)
18 - 24	45 - 52

**Typical Base Material Grades**

- Manganese rock crushing hammers and rolls, impactor bars, gyratory mantles, dredge components

**Features and Applications**

- Applicability in buffer layer and surfacing of carbon- and manganese-steels
- High resistance to impact and friction
- Most common applications in hardfacing of various equipment parts that are exposed to deep impacts, pressure and wearing in cement, mining and earth-moving industries
- Build up depth is generally unlimited. Weld metal hardness increases by work hardening
- Shielding Gas: Open Arc

**Welding Positions**

**Operating Data**

Diameter (mm)	Welding Current (A)	Voltage (V)	Stick-out (mm)
1.60	130 - 220	26.0 - 31.0	25.0 - 30.0
2.80	300 - 500	25.0 - 31.0	25.0 - 30.0

**Current Type**

FCAW / D.C.(+)

**Operating Data**

Product Code	Diameter x Length (mm) / (inch)		Package Weight (Kg)
6031100379	1.60	1/16	15
6031100380	2.80	7/64	25

**Approvals:** GOST-R, CE, SEPRO

**Standards**

TS EN 14700	: T Fe9
EN 14700	: T Fe9
DIN 8555	: MF 7-GF-200 KP

**Chemical Composition of  
Weld Metal (Typical)**

C	Si	Mn	Ni	Fe
0.55	0.10	12.8	2.50	Rest

**Mechanical Properties**

Hardness	
(As Welded) (HB)	(After Working) (HB)
170 - 200	~ 500

**Typical Base Material Grades**

- Flux cored wire contains %12Mn.
- Weld metal microstructure is austenitic therefore has excellent impact resistance

**Features and Applications**

- GeKaTec HARDCOR 14Mn G is used for joining and buildups of work pieces made of hard austenitic manganese steels subjected to impact and abrasion wears
- Weld deposit ensures workhardening under impact and shock because of fully austenitic structure
- Used in crusher cylinders, crusher hammers and jaws made of %12 - 14 Mn Steels
- Shielding Gas: CO<sub>2</sub> (M21)

**Welding Positions**

**Operating Data**

Diameter (mm)	Welding Current (A)	Voltage (V)	Stick-out (mm)
1.20	170 - 200	27.0 - 30.0	25.0 - 30.0
1.60	180 - 220	26.0 - 31.0	25.0 - 30.0

**Current Type**

FCAW / D.C.(+)

**Operating Data**

Product Code	Diameter x Length (mm) / (inch)		Package Weight (Kg)
3030500020	1.20	0.047"	15
3030500021	1.60	0.062"	15

**Approvals:** GOST-R, CE, SEPRO

**Standards**

TS EN 14700	: T Fe 9
EN 14700	: T Fe 9
DIN 8555	: MF 7-250 KNP

**Chemical Composition of  
Weld Metal (Typical)**

C	Si	Mn	Ni	Cr
1.1	0.3	14.0	0.6	4.0

**Mechanical Properties**

Hardness	
(As Welded) (HB)	(After Working) (HB)
170 - 200	~ 500

**Typical Base Material Grades**

- Flux cored wire contains % 14 Mn, weld metal microstructure is austenitic therefore has excellent impact resistance

**Features and Applications**

- Used in crusher, cylinders, crusher hammers and jaws etc. Made of %14 Mn steels.
- Shielding gas . Open Arc

**Welding Positions**

**Operating Data**

Diameter (mm)	Welding Current (A)	Voltage (V)	Stick-out (mm)
1.60	130 - 220	26.0 - 30.0	25.0 - 30.0

**Current Type**

FCAW / D.C.(+)

**Operating Data**

Product Code	Diameter x Length (mm) / (inch)		Package Weight (Kg)
6031100199	1.60	0.062"	15

**Approvals:** GOST-R, CE, SEPRO

**Standards**

TS EN 14700	: T Z Fe 8
EN 14700	: T Z Fe 8
DIN 8555	: MF 3-50-CKTZW

**Chemical Composition of  
Weld Metal % (Typical)**

C	Si	Mn	Cr	Ni	Mo	Co	Fe
0.1	0.7	0.4	15.0	+	3.2	14	Rest

**Mechanical Properties**

Hardness	
(As Welded) (HRC)	(After Working) (HRC)
48 - 50	53

**Typical Base Material Grades**

- Hardfacing of hot-work tool steels, forging dies, hot-shearing tools, punch tools, punch tools, rollers, hot hardening treatment, steel mill rolls Continuous casting driving rolls, dies, mandrels, forming tools, pumps

**Features and Applications**

- Applicability in hardfacing for protection against wear of steels working at temperature sup to 650°C
- Existence of high amounts of Cr, Co, Mo alloys in weld metal
- High resistance to cracking
- Oxidation-and creep resistant behaviours at high temperatures
- High resistance against sliding wearof metallic object
- High resistance to thermal shock
- Shielding Gas: M 13 (Ar+1%O<sub>2</sub>)

**Welding Positions**

**Operating Data**

Diameter (mm)	Welding Current (A)	Voltage (V)	Stick-out (mm)
1.20	170 - 200	27 - 30	15 - 25

**Current Type**

FCAW / D.C. (+)

**Operating Data**

Product Code	Diameter x Length (mm) / (inch)		Package Weight (Kg)
6031100370	1.20	0.047"	15

Approvals: GOST-R, CE, SEPRO

### Standards

TS EN 14700	: T Fe15
EN 14700	: T Fe15
DIN 8555	: MF 10-GF-55 G

### Chemical Composition of Weld Metal % (Typical)

C	Si	Mn	Cr	Fe
4.80	1.20	1.20	27.0	Rest

### Mechanical Properties

Hardness
(As Welded) (HRC)
58 - 62

### Typical Base Material Grades

- Hardfacing of bucket teeth, excavator buckets, brick pres spring, fan blades, drills, mixer and blades, grinding/pulverizing rolls and table segments, wear plates, clad pipe, dredge pump shells and related components, hammers.

### Features and Applications

- Open arc, hardfacing flux cored wire with Cr-Carbides
- Used in hardfacing welding of parts exposed to high abrasive wear
- It is common to have transverse cracks on weld seam
- Weld metal can be machined by grinding
- Max. two passes can be weld with this wire

### Welding Positions



### Operating Data

Diameter (mm)	Welding Current (A)	Voltage (V)	Stick-out (mm)
2.80	300 - 500	25.0 - 31.0	25.0 - 30.0

### Current Type

FCAW / D.C.(+)

### Operating Data

Product Code	Diameter x Length (mm) / (inch)		Package Weight (Kg)
6031100371	2.80	7/64	25

Approvals: GOST-R, CE, SEPRO

**Standards**

TS EN 14700	: T Fe8
EN 14700	: T Fe8
DIN 8555	: MF 6 GF 55 GT

**Chemical Composition of  
Weld Metal (Typical)**

C	Si	Mn	Cr	Mo	W	V
0.65	0.50	1.55	7.20	1.00	1.60	0.10

**Mechanical Properties**

<b>Hardness</b>
(As Welded) (HRC)
53 - 56

**Features and Applications**

- This hardfacing flux cored wire has excellent wear resistance and keeps its strength at high temperatures
- Used in cold and hot work tool steels, hot shape knives, extrusion die and steel casting and dies
- Shielding gas : M21

**Welding Positions**

**Operating Data**

Diameter (mm)	Welding Current (A)	Voltage (V)	Stick-out (mm)
1.20	150 - 220	26 - 30	20 - 25

**Current Type**

FCAW / D.C. (+)

**Operating Data**

Product Code	Diameter x Length (mm) / (inch)		Package Weight (Kg)
3030500024	1.20	0.047"	15

Approvals: GOST-R, CE, SEPRO

**Standards**

TS EN 14700	: T Fe8
EN 14700	: T Fe8
DIN 8555	: MF 10-GF-55-GP

**Chemical Composition of  
Weld Metal % (Typical)**

C	Si	Mn	Cr	Mo	Ti	Fe
1.80	1.5	2.0	7.0	1.4	5.0	Rest

**Mechanical Properties**

<b>Hardness</b>
(As Welded) (HRC)
52 - 57

**Typical Base Material Grades**

- Roller presses, grinding/pulverizing rolls, dredge pump shells, rock crushing hammers, shredders, asphalt, kneaders, crashing hard materials, vertical shaft impact crusher rotors, roller presses.

**Features and Applications**

- FC wire containing C, Cr, Ti and Mo alloys
- Weld metals with martensitic microstructure including titanium carbide
- High resistance to wear and to impact
- Machinability of weld metal through grinding
- Best suited for applications involving extreme wear under high pressure
- Shielding Gas: Open Arc

**Welding Positions**

**Operating Data**

Diameter (mm)	Welding Current (A)	Voltage (V)	Stick-out (mm)
1.60	130 - 220	26.0 - 30.0	25.0 - 30.0
2.80	300 - 500	25.0 - 30.0	25.0 - 30.0

**Current Type**

FCAW / D.C.(+)

**Operating Data**

Product Code	Diameter x Length (mm) / (inch)		Package Weight (Kg)
6031100372	1.60	1/16	15
6031100373	2.80	7/64	25

**Approvals:** GOST-R, CE, SEPRO

**Standards**

TS EN 14700	: T Fe 15
EN 14700	: T Fe 15
DIN 8555	: MF 10-GF-60 G

**Chemical Composition of  
Weld Metal % (Typical)**

C	Si	Mn	Cr	Fe
5.0	1.5	1.3	27.0	Rest

**Mechanical Properties**
**Hardness**

(As Welded) (HRC)

60 - 64

**Typical Base Material Grades**

- Ventilators, wear plates, crushers for soft materials, shredders, chemical and food processing industries.

**Features and Applications**

- Open arc, hardfacing flux cored wire with Cr-Carbides
- It is suitable for low alloyed steel and carbon steels
- Weld metal is very hard and it is common to have transverse cracks on weld seam
- Max. two passes can be weld with this wire

**Welding Positions**

**Operating Data**

Diameter (mm)	Welding Current (A)	Voltage (V)	Stick-out (mm)
1.60	130 - 220	26.0 - 31.0	20.0 - 25.0
2.80	300 - 500	25.0 - 31.0	20.0 - 25.0

**Current Type**

FCAW / D.C. (+)

**Operating Data**

Product Code	Diameter x Length (mm) / (inch)		Package Weight (Kg)
6031100374	1.60	1/16	15
6031100186	2.80	7/64	25

**Approvals:** GOST-R, CE, SEPRO



**Standards**

TS EN 14700	: T Fe15
EN 14700	: T Fe15
DIN 8555	: MF 10 GF-65-G

**Chemical Composition of  
Weld Metal % (Typical)**

C	Si	Mn	Cr	Nb	Fe	B
5.2	1.3	0.4	22.0	7.0	Rest	1.0

**Mechanical Properties**

<b>Hardness</b>
(As Welded) (HRC)
62 - 65

**Typical Base Material Grades**

- Hardfacing of mining equipments, augers, impellers, dredgers, drills, gearwheels and parts. Fan blades, excavator scoops, bucket lips and wear plates

**Features and Applications**

- Extremely high hardness with specially-proportioned chemical composition including high amounts of C, Cr, Nb, B. High strength to abrasion provided by the special chemical composition
- Shielding Gas : Open Arc

**Welding Positions**

**Operating Data**

Diameter (mm)	Welding Current (A)	Voltage (V)	Stick-out (mm)
1.60	130 - 220	26.0 - 31.0	25.0 - 30.0

**Current Type**

FCAW / D.C. (+)

**Operating Data**

Product Code	Diameter x Length (mm) / (inch)		Package Weight (Kg)
6031100375	1.60	1/16	15

**Approvals:** GOST-R, CE, SEPRO

**Standards**

TS EN 14700	: T Fe 16
EN 14700	: T Fe 16
DIN 8555	: MF 10 GF 65 GT

**Chemical Composition of  
Weld Metal % (Typical)**

C	Mn	Si	Cr	Nb	Mo	W	V	Fe
5.2	0.4	1.0	21.0	7.0	7.0	2.0	1.0	Rest

**Mechanical Properties**

<b>Hardness</b>
(As Welded) (HRC)
63 - 65

**Typical Base Material Grades**

- Clad wear plate, slurry pipe, cement furnace components, sinler plant parts, fan blades, mixer blades, screws

**Features and Applications**

- It is self shielded flux cored hardfacing welding wire composed of a high density of primary chromium with multiple secondary carbides
- Because of the high content of C, Cr, Mo, Nb, W, V and their hard carbides, hardness at the temperatures can be established
- Designed specifically for single and double pass applications in high temperature environments
- Weld deposit contains stres relief cracks, but this does not impair wear resistance

**Welding Positions**

**Operating Data**

Diameter (mm)	Welding Current (A)	Voltage (V)	Stick-out (mm)
1.60	130 - 220	26.0 - 31.0	25.0 - 30.00

**Current Type**

FCAW / D.C. (+)

**Operating Data**

Product Code	Diameter x Length (mm) / (inch)		Package Weight (Kg)
6031100209	1.60	1/16	15

**Approvals:** GOST-R, CE, SEPRO

**Standards**

TS EN 14700	: T Z Fe 16
EN 14700	: T Z Fe 16
DIN 8555	: MF 10 GF 65 G

**Chemical Composition of  
Weld Metal % (Typical)**

C	Mn	Si	Cr	B
~2.00	0.5	0.5	7.5	4.5

**Mechanical Properties**

<b>Hardness</b> (As Welded) (HRC)
65 - 67

**Typical Base Material Grades**

- Repair of equipment used in mining and steel mills. Hardfacing equipment and tools used in the construction and agriculture industries, highway construction equipment, conveyor chains, mixing paddles, cement pumps components, etc

**Features and Applications**

- High-alloy metal powder flux-cored wire without slag for hardfacing preferred without shielding gas
- Use with CO<sub>2</sub> and Ar-CO<sub>2</sub> mix possible
- The weld metal characteristics and structure is similar to hard chrome alloys
- Excellent resistance to abrasion from sand and minerals
- The weld metal is machinable only by grinding
- Stringer bead technique is recommended
- The hardfacing contains check cracks, but this does not impair wear resistance

**Welding Positions**

**Operating Data**

Diameter (mm)	Welding Current (A)	Voltage (V)	Stick-out (mm)
1.60	180 - 350	25.0 - 32.0	20.0 - 25.0

**Current Type**

FCAW / D.C. (+)

**Operating Data**

Product Code	Diameter x Length (mm) / (inch)		Package Weight (Kg)
3030500026	1.60	1/16	15

Approvals: GOST-R, CE, SEPRO

**Standards**

TS EN 14700	: T Co3
EN 14700	: T Co3
DIN 8555	: MF 20-55-CTZ

**Chemical Composition of  
Weld Metal % (Typical)**

C	Mn	Si	W	Fe	Cr	Co
2.4	0.4	0.7	11.0	<3.0	29.0	Rest

**Mechanical Properties**

<b>Hardness</b>
(As Welded) (HRC)
54 -56

**Typical Base Material Grades**

- Best used on wear pads , rolyary seal rings, pump sleeves and centerless grinder work rests.
- Thermal shock resistant, abrasion, erosion, corrosion, cavitation at high temperature, bearing surfaces, chemical industry, hot shear blades, valves

**Features and Applications**

- GeKaTec HARDCOR COBALT 1 deposits a cobalt-based alloy with an austenitic-ledeburitic structure.
- This is the hardest of the standard cobalt-based alloys
- It has a high resistance to corrosion especially to reducing acids, extreme wear and temperature shocks
- The deposit is only machinable by grinding
- Shielding Gas : M13 (Ar+1%O<sub>2</sub>)

**Welding Positions**

**Operating Data**

<b>Diameter</b> (mm)	<b>Welding Current</b> (A)	<b>Voltage</b> (V)
1.60	180 - 300	26.0 - 32.0

**Current Type**

FCAW / D.C. (+)

**Operating Data**

<b>Product Code</b>	<b>Diameter x Length</b> (mm) / (inch)		<b>Package Weight</b> (Kg)
6031100365	1.60	1/16	15

**Approvals:** GOST-R, CE, SEPRO

**Standards**

TS EN 14700	: T Co2
EN 14700	: T Co2
DIN 8555	: MF 20-45-CTZ

**Chemical Composition of  
Weld Metal % (Typical)**

C	Mn	Si	W	Fe	Cr	Co
1.1	0.6	1.0	4.5	<3.0	28.0	Rest

**Mechanical Properties**

<b>Hardness</b> (As Welded) (HRC)
40 - 43

**Typical Base Material Grades**

- Best used on steam and chemical valves and on equipment handling hot steel, such as tong bits, hot steel shear blades, etc. Thermal shock resistant, abrasion, erosion, corrosion, cavitati on at high temperature, bearing surfaces, chemical industry, hot shear blades, valves

**Features and Applications**

- Cobalt-based alloys with an austenitic-ledeburitic structure containing chrome and tungsten carbides
- These alloys are resistant against high corrosion and abrasion, high impact stress and extreme temperature shocks
- The deposit is machinable by hard metal tools
- Shielding Gas: M13 (Ar +1 %O<sub>2</sub>)

**Welding Positions**

**Operating Data**

<b>Diameter</b> (mm)	<b>Welding Current</b> (A)	<b>Voltage</b> (V)
1.20	140 - 200	26.0 - 32.0

**Current Type**

FCAW / D.C. (+)

**Operating Data**

<b>Product Code</b>	<b>Diameter x Length</b> (mm) / (inch)		<b>Package Weight</b> (Kg)
6031100191	1.20	0.047"	15

**Approvals:** GOST-R, CE, SEPRO

**Standards**

TS EN 14700	: T Co3
EN 14700	: T Co3
DIN 8555	: MF 20-50-CTZ

**Chemical Composition of  
Weld Metal % (Typical)**

C	Mn	Si	W	Fe	Cr	Co
1.4	0.8	1.0	8.0	<3.0	29.0	Rest

**Mechanical Properties**

<b>Hardness</b>
(As Welded) (HRC)
48 - 50

**Typical Base Material Grades**

- Thermal shock resistant, abrasion, erosion, corrosion, cavitation at high temperature, bearing surfaces, chemical industry, hot shear blades, valves

**Features and Applications**

- Cobalt based-alloy with high resistance against abrasion, temperature shocks and corrosion
- This alloy is suitable for hardfacing cutting edges of long knives and other tools used in the wood, plastic, paper and chemical industries
- Shielding Gas: M13 (Ar+1%O<sub>2</sub>)

**Welding Positions**

**Operating Data**

Diameter (mm)	Welding Current (A)	Voltage (V)
1.20	140 - 200	26.0 - 30.0

**Current Type**

FCAW / D.C. (+)

**Operating Data**

Product Code	Diameter x Length (mm) / (inch)		Package Weight (Kg)
6031100366	1.20	0.047"	15

**Approvals:** GOST-R, CE, SEPRO

**Standards**

TS EN ISO 17672	: Cu 511
EN ISO 17672	: Cu 511
AWS A5.7	: ER Cu

**Chemical Composition of  
Weld Metal % (Typical)**

Sn	Si	Mn	Cu
0.8	0.3	0.3	Rest

**Mechanical Properties**

Tensile Strength (N/mm <sup>2</sup> )	Impact Strength (J)	Elongation ((L <sub>0</sub> =5d <sub>0</sub> ) (%))	Hardness (HB)	Melting Range (°C)	Electrical Conductivity (20°C) (Sm/mm <sup>2</sup> )	Thermal Conductivity (W/m.K)	Density (kg/dm <sup>3</sup> )
200	70	30	60	1020-1050	15-20	120-170	8.9

**Features and Applications**

- Used in joining and filler welds of blister copper
- The weld metal has strength to the overheat
- Electrode holders, blast furnace tuyeres, some copper parts of radiator and oil coolers are the primary application area of this consumable
- 300°C pre-heat must be done to the copper plates thinner than 3 mm
- Used for steel and nickel brazing
- Shielding gas : TIG (Ar or %75 Ar+ %25He)

**Welding Method**

Gas Welding - TIG Welding

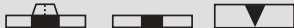
Current Type	MIGWire	Electrode	Welding Positions
TIG D.C.(-)	Geka R1 L	GeKaTec Cu-WELD	

**Operating Data**

Product Code	Diameter x Length (mm) / (inch)		Package Weight (Kg)
6031100086	2.0 x 1000	5/64 x 39"	5

Approvals: GOST-R, SEPRO

### Standards

TS EN ISO 17672	: Cu 681
EN ISO 17672	: Cu 681

### Chemical Composition of Weld Metal % (Typical)

Cu	Sn	Si	Zn
59.0	1.8	0.2	Rest

### Mechanical Properties

Melting Range (°C)	Density (kg/dm <sup>3</sup> )	Tensile Strength (N/mm <sup>2</sup> )	Elongation ((L <sub>0</sub> =5d <sub>0</sub> ) (%))	Hardness (HB)
870-890	8.4	430	30	110

### Features and Applications

- Used in joining and coating of brass, bronze copper, steel and cast iron materials with using Flux F-SH2
- Normal flame must be chosen for steel and copper, oxidizing flame must be chosen for brass, bronze, galvanized materials

### Welding Method

Gas Welding

Other Brazing Rods	Welding Positions
S21, S3	

### Operating Data

Product Code	Diameter x Length (mm) / (inch)		Package Weight (Kg)
6031100240	2.0 x 1000	5/64 X 39"	5
6031100238	3.0 x 1000	1/8 X 39"	5
6031100356	4.0 x 1000	5/32 X 39"	5

Approvals: GOST-R, SEPRO



**Standards**

TS EN ISO 17672	: Cu 470
EN ISO 17672	: Cu 470

**Chemical Composition of  
Weld Metal % (Typical)**

Cu	Sn	Si	Zn
60.0	0.5	0.2	Rest

**Mechanical Properties**

Melting Range (°C)	Density (kg/dm <sup>3</sup> )	Tensile Strength (N/mm <sup>2</sup> )	Elongation ((L <sub>0</sub> =5d <sub>0</sub> ) (%))	Hardness (HB)
875-895	8.4	400	30	100

**Features and Applications**

- Used in joining and coating of brass, bronze copper, steel and cast iron materials with using Flux F-SH2
- Normal Flame must be chosen for steel and copper, oxidizing flame must be chosen for brass, bronze, galvanized materials

**Welding Method**

Gas Welding

Other Brazing Rods	Welding Positions
S2, S3	

**Operating Data**

Product Code	Diameter x Length (mm) / (inch)		Package Weight (Kg)
6031100390	2.0 x 1000	5/64 x 39"	5
6031100355	2.5 x 1000	3/32 x 39"	5
6031100097	3.0 x 1000	1/8 x 39"	5
6031100297	4.0 x 1000	5/32 x 39"	5

**Approvals:** GOST-R, SEPRO

**Standards**

TS EN ISO 17672	: ~ Cu 773
EN ISO 17672	: ~ Cu 773

**Chemical Composition of Weld Metal % (Typical)**

Cu	Ni	Si	Zn
52.0	7.0	0.3	Rest

**Mechanical Properties**

Melting Range (°C)	Density (kg/dm <sup>3</sup> )	Tensile Strength (N/mm <sup>2</sup> )	Elongation ((L <sub>0</sub> =5d <sub>0</sub> ) (%))	Hardness (HB)
890 - 920	8.7	690 - 785	15	130

**Features and Applications**

- Brass brazing rods with silver and nickel alloyed consumable
- Corrosion resistance, wear resistance, mechanical properties are very good
- Used in joining of steels, cast iron, nickel and nickel alloys
- This consumable can be used with Flux F-SH2
- Normal flame must be chosen

**Welding Method**

Gas Welding

Other Brazing Rods	Welding Positions
S2, S21	

**Operating Data**

Product Code	Diameter x Length (mm) / (inch)		Package Weight (Kg)
6031100357	2.0 x 1000	5/64 x 39"	5
6031100293	3.0 x 1000	1/8 x 39"	5
6031100396	4.0 x 1000	5/32 x 39"	5

**Approvals:** GOST-R, SEPRO

**Standards**

TS EN ISO 17672: Cu 922
EN ISO 17672 : Cu 922
AWS A5.7 : ER CuSn-A

**Chemical Composition of Weld Metal % (Typical)**

Cu	Sn	P
Rest	6.0	0.20

**Mechanical Properties**

Melting Range (°C)	Density (kg/dm <sup>3</sup> )	Tensile Strength (N/mm <sup>2</sup> )	Yield Strength (N/mm <sup>2</sup> )	Elongation ((L <sub>0</sub> =5d <sub>0</sub> ) (%))	Hardness (HB)
910-1040	8.7	300	150	20	80

**Features and Applications**

- Highly wear resistant, good anti-friction properties suitable for joining copper-zinc alloys and coating of cast irons and steel materials and dissimilar materials like as steel and bronze
- Applications include bearing faces , art bronze, axle bearing
- Shielding Gas for TIG Welding: Ar
- Normal flame must be chosen
- 100 - 250°C pre-heat temperature must be done thicker than 10 mm materials

**Welding Method**

Gas Welding - TIG Welding

Current Type	MIG Wire	Electrode	Welding Positions
TIG D.C.(-)	GeKa R4 L	GeKaTec Bronze	

**Operating Data**

Product Code	Diameter x Length (mm) / (inch)		Package Weight (Kg)
6031100388	2.0 x 1000	5/64 x 39"	5

**Approvals:** GOST-R, SEPRO

**Standards**

TS EN ISO 17672	: ~ Cu 565
EN ISO 17672	: ~ Cu 565
AWS A5.7	: ~ ER CuAl-A1

**Chemical Composition of  
Weld Metal % (Typical)**

Al	Fe	Mn	Ni	Cu
7.5-10	0.5-1.5	<1.0	<1.0	Rest

**Mechanical Properties**



Melting Range (°C)	Density (kg/dm <sup>3</sup> )	Tensile Strength (N/mm <sup>2</sup> )	Elongation (L <sub>0</sub> =5d <sub>0</sub> ) (%)	Hardness (HB)
1030 - 1040	7.5	580	20	130

**Features and Applications**

- Weld metal is resistance to sea water, corrosion and cavitation
- Used in joining of steels, copper to copper alloys
- Resistant to deformation at elevated temperatures and corrosion resistant for armouring parts of machinery
- Applications include propellers, thrust plates, picking bails
- Shielding Gas for TIG Welding : Ar.

**Welding Method**

Gas Welding - TIG Welding

Current Type	MIG Wire	Electrode	Welding Positions
TIG D.C.(-)	Geka R1 L	GeKaTec Cu-WELD	 

**Operating Data**

Product Code	Diameter x Length (mm) / (inch)		Package Weight (Kg)
6031100387	2.0 x 1000	5/64 x 39"	5

Approvals: GOST-R, SEPRO

**Standards**

TS EN ISO 17672	: Cu P 180
EN ISO 17672	: Cu P 180
AWS A5.8	: B Cu P-2

**Chemical Composition of  
Weld Metal % (Typical)**

Cu	P
93.0	7.0

**Mechanical Properties**

Working Temperatures (°C)	Density (kg/dm <sup>3</sup> )	Tensile Strength (N/mm <sup>2</sup> )	Elongation ((L <sub>0</sub> =5d <sub>0</sub> ) (%))	Melting Range (°C)
720	8.1	250	5	710 - 820

**Features and Applications**

- Used in brazing of copper and copper alloys, bronze and casting brass. materials, has high liquidity properties
- This consumables do not use in brazing of nickel and steel materials
- There is no need flux for joining of copper to copper
- Reducing flame must be used

**Welding Method**

Brazing

**Welding Positions**

**Operating Data**

Product Code	Diameter x Length (mm) / (inch)		Package Weight (Kg)
6031100294	1.5 x 500	1/16 x 20"	1
6031100295	2.0 x 500	5/64 x 20"	1
6031100296	3.0 x 500	1/8 x 20"	1

**Approvals:** GOST-R, SEPRO

**Standards**

TS EN ISO 17672	: Cu P 279
EN ISO 17672	: Cu P 279

**Chemical Composition of  
Weld Metal % (Typical)**

Cu	P	Ag
91.8	6.2	2.0

**Mechanical Properties**

Working Temperatures (°C)	Density (kg/dm <sup>3</sup> )	Tensile Strength (N/mm <sup>2</sup> )	Elongation ((L <sub>0</sub> =5d <sub>0</sub> ) (%))	Hardness (HB)
710	8.1	250	5	650 - 810

**Features and Applications**

- Used in copper and copper alloys, casting brass and bronze brazing
- It is not used in nickel and steel materials brazing
- FLUX F-SH1 can used and normal flame must be choosen

**Welding Method**

Brazing

Other Brazing Rods	Welding Positions
GeKa L-Ag5P, L-Ag15P	

**Operating Data**

Product Code	Diameter x Length (mm) / (inch)		Package Weight (Kg)
6031100276	1.5 x 500	1/16 x 20"	1
6031100277	2.0 x 500	5/64 x 20"	1
6031100278	3.0 x 500	1/8 x 20"	1

**Approvals:** GOST-R, SEPRO

**Standards**

TS EN ISO 17672	: Cu P 281
EN ISO 17672	: Cu P 281
AWS A5.8	: B Cu P-3

**Chemical Composition of  
Weld Metal % (Typical)**

Ag	P	Cu
5.0	6.0	89.0

**Mechanical Properties**

Working Temperatures (°C)	Density (kg/dm <sup>3</sup> )	Tensile Strength (N/mm <sup>2</sup> )	Elongation ((L <sub>0</sub> =5d <sub>0</sub> ) (%))	Melting Range (°C)
710	8.2	250	8	650 - 810

**Features and Applications**

- Used in copper and copper alloys, casting brass and bronze brazing
- This consumable has higher creep properties according to the L-Ag 2P
- It is not used in brazing nickel and steel materials
- Flux F-SH1 can be used and normal flame must be chosen

**Welding Method**

Brazing

Other Copper-Silver-Phosphor Brazing Rods	Welding Positions
GeKaTec L-Ag5P, L-Ag15P	

**Operating Data**

Product Code	Diameter x Length (mm) / (inch)		Package Weight (Kg)
6031100288	2.0 x 500	5/64 x 20"	1

**Approvals:** GOST-R, SEPRO

**Standards**

TS EN ISO 17672	: Cu P 284
EN ISO 17672	: Cu P 284
AWS A5.8	: B Cu P-5

**Chemical Composition of  
Weld Metal % (Typical)**

Ag	P	Cu
15.0	5.0	80.0

**Mechanical Properties**

Working Temperatures (°C)	Density (kg/dm <sup>3</sup> )	Tensile Strength (N/mm <sup>2</sup> )	Elongation ((L <sub>0</sub> =5d <sub>0</sub> ) (%))	Hardness (HB)
710	8.4	250	10	650 - 800

**Features and Applications**

- Used in copper and copper alloys, casting brass and bronze brazing
- This consumable has higher creep properties according to the L-Ag5P
- It is not used in brazing of nickel and steel materials
- Flux F-SH1 can be used and normal flame must be chosen

**Welding Method**

Brazing

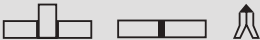
Other Copper-Silver-Phosphor Brazing Rods	Welding Positions
GeKaTec L-Ag5P, L-Ag15P	

**Operating Data**

Product Code	Diameter x Length (mm) / (inch)		Package Weight (Kg)
6031100275	2.0 x 500	5/64 x 20"	1
6031100056	3.0 x 500	1/8 x 20"	1
6031100057	4.0 x 500	5/32 x 20"	1

**Approvals:** GOST-R, SEPRO



**Standards**

EN 1044 : B-Cu 40 ZnAgCd(-AG 309)

**Chemical Composition of  
Weld Metal % (Typical)**

Ag	Cu	Si	Cd	Zn
20.0	40.0	0.2	15.0	Rest

**Mechanical Properties**

Working Temperatures (°C)	Density (kg/dm <sup>3</sup> )	Tensile Strength (N/mm <sup>2</sup> )	Elongation ((L <sub>0</sub> =5d <sub>0</sub> ) (%))	Melting Range (°C)
750	8.8	350 - 430	25	605 - 765

**Features and Applications**

- Used in copper and copper alloy. steel, stainless steel and nickel and nickel alloys brazing and joining of these materials each others
- Flux F-SH1 can be used and reducing flame must be chosen

**Welding Method**

Brazing

**Other Copper-Silver-Phosphor Brazing Rods**

GeKaTec L-Ag20FC, L-Ag30, L-Ag30FC, L-Ag40, L-Ag40FC, L-Ag55, L-Ag55FC

**Welding Positions**

**Operating Data**

Product Code	Diameter x Length (mm) / (inch)		Package Weight (Kg)
6031100279	1.5 x 500	1/16 x 20"	1
6031100062	2.0 x 500	5/64 x 20"	1
6031100280	3.0 x 500	1/8 x 20"	1

**Approvals:** GOST-R, SEPRO

**Standards**
**Chemical Composition of  
Weld Metal % (Typical)**

EN 1044 B-Cu 40 ZnAgCd(~AG 309)

Ag	Cu	Si	Cd	Zn
20.0	40.0	0.2	15.0	Rest

**Mechanical Properties**

Working Temperatures (°C)	Density (kg/dm <sup>3</sup> )	Tensile Strength (N/mm <sup>2</sup> )	Elongation ((L <sub>0</sub> =5d <sub>0</sub> ) (%))	Melting Range (°C)
750	8.8	350 - 430	25	605 - 765

**Features and Applications**

- Used in copper and copper alloys, nickel and nickel alloys, cast iron, steel, stainless brazing and joining of these materials each others
- L-Ag20FC is a kind of flux coated brazing rods with %20Ag
- Reducing flame must be chosen

**Welding Method**

Brazing

**Other Copper-Silver-Phosphor Brazing Rods**

 GeKaTec L-Ag20 , L-Ag30 , L-Ag30FC , L-Ag40,  
 L-Ag40FC, L-Ag55, L-Ag55FC

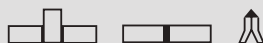
**Welding Positions**

**Operating Data**

Product Code	Diameter x Length (mm) / (inch)		Package Weight (Kg)
6031100064	1.5 x 500	1/16 x 20"	1
6031100281	2.0 x 500	5/64 x 20"	1
6031100066	3.0 x 500	1/8 x 20"	1

**Approvals:** GOST-R, SEPRO

**Standards**

TS EN ISO 17672	: Ag 330
EN ISO 17672	: Ag 330

**Chemical Composition of  
Weld Metal % (Typical)**

Ag	Cu	Zn	Si	Cd
30.0	28.0	Rest	0.5	21.0

**Mechanical Properties**

Working Temperatures (°C)	Density (kg/dm <sup>3</sup> )	Tensile Strength (N/mm <sup>2</sup> )	Elongation ((L <sub>0</sub> =5d <sub>0</sub> ) (%))	Melting Range (°C)
680	9.2	380 - 470	30	600 - 690

**Features and Applications**

- Used in copper and copper alloy, steel, stainless steel and nickel and nickel alloys brazing and joining of these materials each others
- Flux F-SH1 can be used and reducing flame must be chosen

**Welding Method**

Brazing

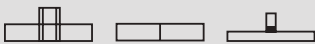
Other Copper-Silver-Phosphor Brazing Rods	Welding Positions
GeKaTec L-Ag20 , L-Ag20FC, L-Ag30FC, L-Ag40, L-Ag40FC, L-Ag55, L-Ag55FC	

**Operating Data**

Product Code	Diameter x Length (mm) / (inch)		Package Weight (Kg)
6031100282	1.5 x 500	1/16 x 20"	1
6031100068	2.0 x 500	5/64 x 20"	1
6031100283	3.0 x 500	1/8 x 20"	1

**Approvals:** GOST-R, SEPRO

**Standards**

TS EN ISO 17672	: Ag 330
EN ISO 17672	: Ag 330

**Chemical Composition of  
Weld Metal % (Typical)**

Ag	Cu	Zn	Si	Cd
30.0	28.0	Rest	0.5	21.0

**Mechanical Properties**

Working Temperatures (°C)	Density (kg/dm <sup>3</sup> )	Tensile Strength (N/mm <sup>2</sup> )	Elongation ((L <sub>0</sub> =5d <sub>0</sub> ) (%))	Melting Range (°C)
680	9.2	380 - 470	30	600 - 690

**Features and Applications**

- Used in copper and copper alloy, nickel and nickel alloys, cast iron, steel, stainless brazing and joining of these materials each others
- L-Ag 30FC is a kind of flux coated brazing rods with %30 Ag

**Welding Method**

Brazing

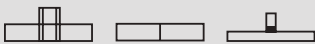
Other Copper-Silver-Phosphor Brazing Rods	Welding Positions
GeKaTec L-Ag20 , L-Ag20FC, L-Ag30FC, L-Ag40, L-Ag40FC, L-Ag55, L-Ag55FC	

**Operating Data**

Product Code	Diameter x Length (mm) / (inch)		Package Weight (Kg)
6031100070	1.5 x 500	1/16 x 20"	1
6031100071	2.0 x 500	5/64 x 20"	1
6031100072	3.0 x 500	1/8 x 20"	1

**Approvals:** GOST-R, SEPRO

**Standards**

TS EN ISO 17672	: Ag 340
EN ISO 17672	: Ag 340

**Chemical Composition of  
Weld Metal % (Typical)**

Ag	Cu	Zn	Si	Cd
40.0	20.0	Rest	0.5	21.0

**Mechanical Properties**

Working Temperatures (°C)	Density (kg/dm <sup>3</sup> )	Tensile Strength (N/mm <sup>2</sup> )	Elongation ((L <sub>0</sub> =5d <sub>0</sub> ) (%))	Melting Range (°C)
610	9.3	410 - 510	25	595 - 630

**Features and Applications**

- Used in copper and copper alloy, steel, stainless steel and nickel and nickel alloys brazing and joining of these materials each others
- Flux F-SH1 can be used and reducing flame must be chosen

**Welding Method**

Brazing

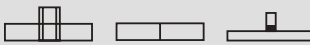
Other Copper-Silver-Phosphor Brazing Rods	Welding Positions
GeKaTec L -Ag20, L-Ag20FC, L-Ag30, L-Ag30FC, L-Ag40FC , L-Ag55, L-Ag55FC	

**Operating Data**

Product Code	Diameter x Length (mm) / (inch)		Package Weight (Kg)
6031100073	1.5 x 500	1/16 x 20"	1
6031100074	2.0 x 500	5/64 x 20"	1
6031100284	3.0 x 500	1/8 x 20"	1

**Approvals:** GOST-R, SEPRO

**Standards**

TS EN ISO 17672	: Ag 340
EN ISO 17672	: Ag 340

**Chemical Composition of  
Weld Metal % (Typical)**

Ag	Cu	Zn	Si	Cd
40.0	20.0	Rest	0.5	21.0

**Mechanical Properties**

Working Temperatures (°C)	Density (kg/dm <sup>3</sup> )	Tensile Strength (N/mm <sup>2</sup> )	Elongation ((L <sub>0</sub> =5d <sub>0</sub> ) (%))	Melting Range (°C)
610	9.3	410 - 510	25	595 - 630

**Features and Applications**

- Used in copper and copper alloy, nickel and nickel alloys, cast iron, steel, stainless brazing and joining of these materials each others
- L-Ag 30FC is a kind of flux coated brazing rods with %30 Ag

**Welding Method**

Brazing

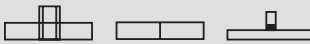
Other Copper-Silver-Phosphor Brazing Rods	Welding Positions
GeKaTec L-Ag20, L-Ag20FC, L-Ag30, L-Ag30FC, L-Ag40, L-Ag55, L-Ag55FC	

**Operating Data**

Product Code	Diameter x Length (mm) / (inch)		Package Weight (Kg)
6031100285	1.5 x 500	1/16 x 20"	1
6031100286	2.0 x 500	5/64 x 20"	1
6031100078	3.0 x 500	1/8 x 20"	1

**Approvals:** GOST-R, SEPRO

**Standards**

TS EN ISO 17672	: Ag 155
EN ISO 17672	: Ag 155

**Chemical Composition of  
Weld Metal % (Typical)**

Ag	Cu	Zn	Sn
55.0	21.0	22.0	2.0

**Mechanical Properties**

Working Temperatures (°C)	Density (kg/dm <sup>3</sup> )	Tensile Strength (N/mm <sup>2</sup> )	Elongation ((L <sub>0</sub> =5d <sub>0</sub> ) (%))	Melting Range (°C)
650	9.4	330 - 430	25	620 - 660

**Features and Applications**

- It is a kind of brazing rods does not contain cadmium
- It is resistance to sea water and corrosion
- Used in medikits and food sectors and also used copper and copper alloys, nickel and nickel alloys, cast irons, steel, stainless steels brazing and joining each others
- Flux F-SH1 can be used and reducing flame must be chosen

**Welding Method**

Brazing

Other Copper-Silver-Phosphor Brazing Rods	Welding Positions
GeKaTec L-Ag20, L-Ag20FC, L-Ag30, L-Ag30FC, L-Ag40, L-Ag40FC, L-Ag55FC	

**Operating Data**

Product Code	Diameter x Length (mm) / (inch)		Package Weight (Kg)
6031100081	1.5 x 500	1/16 x 20"	1
6031100698	2.0 x 500	5/64 x 20"	1
6031100699	3.0 x 500	1/8 x 20"	1

**Approvals:** GOST-R, SEPRO

**Standards**

TS EN ISO 17672	: Ag 155
EN ISO 17672	: Ag 155

**Chemical Composition of  
Weld Metal % (Typical)**

Ag	Cu	Zn	Sn
55.0	21.0	22.0	2.0

**Mechanical Properties**

Working Temperatures (°C)	Density (kg/dm <sup>3</sup> )	Tensile Strength (N/mm <sup>2</sup> )	Elongation ((L <sub>0</sub> =5d <sub>0</sub> ) (%))	Melting Range (°C)
650	9.4	330 - 430	25	620 - 660

**Features and Applications**

- It is a kind of brazing rods does not contain cadmium
- It has resistance to sea water and corrosion
- Used in medikits and food sectors and also used in copper and copper alloys, nickel and nickel alloys, cast irons, steel, stainless steel brazing and joining each others
- L-Ag 55 FC is a kind of flux coated brazing rod with %55 Ag

**Welding Method**

Brazing

Other Copper-Silver-Phosphor Brazing Rods	Welding Positions
GeKaTec L-Ag20, L-Ag20FC, L-Ag30, L-Ag30FC, L-Ag40, L-Ag40FC, L-Ag55FC	

**Operating Data**

Product Code	Diameter x Length (mm) / (inch)		Package Weight (Kg)
6031100289	1.5 x 500	1/16 x 20"	1
6031100290	2.0 x 500	5/64 x 20"	1
6031100291	3.0 x 500	1/8 x 20"	1

**Approvals:** GOST-R, SEPRO



**FLUX F-SH1** TS EN 1045: FH 10

This flux is flour based and used with application of silver alloyed brazing materials. Working temperature is between 550 and 750°C. This flux is used on all base metals except aluminium and aluminium alloys. This product is sold as both powder and paste form

**FLUX F-LH1**

This is a flour based flux used for welding and brazing applications of aluminium and aluminium alloyed materials. Working temperature is between 500°C and 650°C and sold in powder form

**Operating Data**

<b>Product</b>	<b>Product Code</b>	<b>Application Materials</b>	<b>Package Weight (Kg)</b>
FLUX F-SH1 (powder)	6031100020	Silver	1
FLUX F-LH1 (powder)	6031100018	Aluminium	2



**GeKa** WELDING ELECTRODES  
KAYNAK ELEKTROTLARI

SCHWEIßELEKTRODEN  
ELECTRODES ENROBES  
ELECTRODES PER SALDATURA  
ELECTRODES PARA SOLDAR  
CBAPO-HEBE 3HEKTPOIM  
القطب الحام

**GeKa® ELIT**  
3,33x200mm 330-Pow. Al-arc  
Welding Electrode 330A  
Welding Electrode 330A  
www.geka.com.tr

# PACKAGING INFORMATION

# PACKAGING OF WELDING WIRES



**1 Pallet**  
72 Spools-1080 kg.

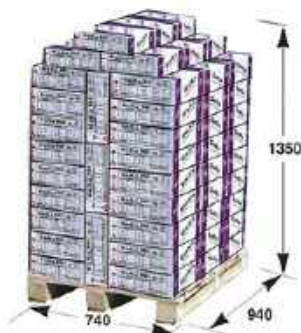

**1 Pallet**  
72 Spools-1080 kg.

**1 Container**  
18 Pallet-19.440 kg



**1 Pallet**  
56 Spools-840 kg.  
56 Spools-1.850 lb

72 Spools-1080 kg.  
72 Spools-2319 lb

**1 Container**  
22 Pallet-18.480 kg  
22 Pallet-40.405 lb

22 Pallet-23.760 kg  
22 Pallet-52.335 lb

# PACKAGING OF WELDING WIRES

## BIG PACK



### For Gas Shielded Arc Welding Wires

250 kg. / 550 lb.

400 kg. / 900 lb.

### For Submerged Arc Welding Wires

400 kg. / 900 lb.

600 kg. / 1322 lb.

1000 kg. / 2203 lb.

## PACKAGING OF WELDING WIRES



## PLASTIC & BASKET SPOOLS

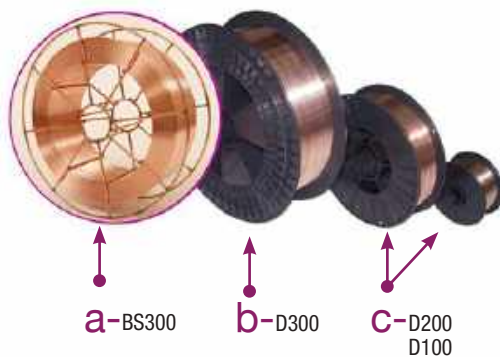

### For Gas Shielded Arc Welding Wires

- \*a - Centered Basket Spool - 15 kg.
- \*b - Plastic Spool - 15 or 20 kg. / 33 or 44 lb.
- \*c - Mini Plastic Spool - 5 or 1 kg. / 11 or 2 lb.

### For Submerged Arc Welding Wires

- \*d - Basket Spool - 25 kg / 30 kg / 100 kg.



## PACKAGING OF WELDING ELECTRODES

TIN BOXES &  
CARTON  
BOXES



VACUUM  
PACKS



PLASTIC  
BOXES





**GeKaMac**



# WELDING AND CUTTING MACHINES





MMA (Manuel Metal Arc)



MIG-MAG (Metal Active Gas-Metal Inert Gas)



TIG (Tungsten Inertgas)



Plasma Cutting



MIG-MAG Pulse



Submerged Arc Welding



Gouging



Inverter



Synergic



CC: Constant Current/ CV: Constant Voltage



CC: Constant Current



Direct Current (Plus/Minus Pole)



Alternating Current / Direct Current



Pulse Welding Mode



Digital Amperemeter / Voltmeter



Digital Amperemeter



Digital Panel



Single Phase



Three Phase



Power Factor Currention



Step Control



Mechanical Control



Tyristor Control



Spot Timer



Lift-TIG



Voltage Reduction Device



Hot Start



Arc Force

**Inverter**

- Inverter type DC Welding Machine
- IGBT based technology
- Low energy consumption
- Thermal protection
- Easy to carry, ergonomic design
- Electrode antisticking function
- Excellent welding characteristics with rutile & basic electrodes with Ø 2.0 - Ø 3.2 mm
- LIFT-TIG available



Input Voltage	V	1 Phase 230 V, 50/60 Hz
Installed Power	kVA	6,42
Fuse (delayed action)	A	20
Open Circuit Voltage	V	63
Current Range	A	30 - 160
Duty Cycle at (40 °C)	%30	160 A
Standards	<b>EN 60974-1 / EN 60974-10</b>	
Protection Class	IP	23
Insulation Class	H	
Dimensions ((L *W*H)	mm	365 / 150 / 240
Weight	kg	7,5

**STANDARD & OPTIONAL EQUIPMENTS**

This Order Code Covers The Welding Machine and All of The Equipments

**3000900020**

**3020900120**

**2020900841**

**2020900842**

**6051900088**  
(Optional)

GEDIK Welding provides full support for after sales services. 1 year warranty.



- Inverter type DC Welding Machine
- IGBT technology
- Low energy consumption
- Thermal protection
- High voltage protection
- Small and light
- "Anti-stick" system to prevent the electrode from sticking
- Excellent welding characteristics with rutile & basic electrodes with Ø 2.0-Ø 4.0 mm
- Allows welding by Lift TIG

Inverter



Input Voltage	V	1 Phase 230 V, 50/60 Hz
Installed Power	kVA	6,8
Fuse (delayed action)	A	31
Open Circuit Voltage	V	63
Current Range	A	10 - 200
Duty Cycle at (40°C)	%30-%60-%100	200 A - 145 A - 110 A
Standards		<b>EN 60974-1 / EN 60974-10</b>
Protection Class	IP	23
Insulation Class		H
Dimensions ((L*W*H)	mm	300 / 150 / 290
Weight	kg	4,5

## STANDARD & OPTIONAL EQUIPMENTS

This Order Code Covers The Welding Machine and All of The Equipments  
3000900026



3020900143



2020900841



2020900842



6051900088  
(Optional)

GEDIK Welding provides full support for after sales services. 1 year warranty.

**Inverter**

- IGBT based technology
- Excellent welding characteristics with  $\varnothing$  2.5 mm -  $\varnothing$  5.0 mm rutile & basic electrodes
- Electrode antisticking function
- Thermal protection (microprocessor controlled)
- LIFT-TIG available
- Low energy consumption
- Easy to carry, ergonomic design
- Metallic main structure
- Shock-proof control panel



Input Voltage	V	3 Phase, 50/60 Hz 380 V $\pm$ 10%
Installed Power	kVA	11.6
Fuse (delayed action)	A	16
Open Circuit Voltage	V	95
Current Range	A	30 - 250
Duty Cycle at (40°C)	%45 %60 %100	250A / 220A / 180A
Standards		<b>EN 60974-1 / EN 60974-10</b>
Protection Class	IP	21
Insulation Class		F
Dimensions ((L*W*H)	mm	410 / 180 / 350
Weight	kg	15

**STANDARD & OPTIONAL EQUIPMENTS**

This Order Code Covers The Welding Machine and All of The Equipments

**3000900014**

**3020900116**

**2020900723**

**2020900724**

**6051900088**  
(Optional)

GEDIK Welding provides full support for after sales services. 1 year warranty.



Inverter

- Digital control of all welding parameters
- Excellent welding characteristics in MMA with any kind of electrodes, including cellulosic
- Adjustable HOT START to improve arc striking with the most difficult electrodes, adjustable ARC FORCE to choose the best arc dynamic characteristics
- Electrode Antisticking function
- Suitable to be used with main cable lengths over 100 m
- Automatic compensation for main voltage fluctuations within  $\pm 20\%$ , ENERGY SAVING function to operate the power source cooling fan only when necessary.
- Possibility of memorizing welding parameters (99 JOB's/ programs) STAND BY function on the remote control
- IP 23 protection class and dust-proof electronic components, thanks to the innovative "Tunnel" fan cooling system, allow operation in the toughest work environments
- LIFT-TIG available
- VRD device reduces the open circuit voltage to value below 12 V



Input Voltage	V	3 Phase, 50/60 Hz, 400 V, $\pm 20\%$
Installed Power	kVA	10
Fuse (delayed action)	A	10
Open Circuit Voltage	V	100
Current Range	A	5-270
Duty Cycle at (40°C)	%100 %60 %30	200 / 220 / 270
Standards		<b>EN 60974-1 / EN 60974-10</b>
Protection Class	IP	23 S
Insulation Class		F
Dimensions ((L*W*H)	mm	430/185/390
Weight	kg	14.5

## STANDARD & OPTIONAL EQUIPMENTS

This Order Code Covers The Welding Machine and All The Equipments

3021000053



1021000031



2020900647



2020900648



6051900088  
(Optional)



6051300012  
(Optional)

GEDIK Welding provides full support for after sales services. 1 year warranty.

**Inverter**

- Digital control of all welding parameters
- Excellent welding characteristics in MMA with any kind of electrodes, including cellulosic
- Adjustable HOT START to improve arc striking with the most difficult electrodes. Adjustable ARC FORCE to choose the best arc dynamic characteristics, electrode Antisticking function
- Quality welds with minimal spatter due to precise controls
- Suitable to be used with main cable lengths over 100 m
- Automatic compensation for main voltage fluctuations within  $\pm 20\%$
- ENERGY SAVING function to operate the power source cooling fan only when necessary
- Possibility of memorizing welding parameters (99 JOB's/programs).
- IP 23 protection class and dust-proof electronic components, thanks to the innovative. "Tunnel" fan cooling system, allow operation in the toughest work environments
- Lift - TIG available
- VRD device reduces the open circuit voltage to value below 12 V



Input Voltage	V	3 Phase, 50/60 Hz, 400 V, $\pm 20\%$
Installed Power	kVA	17.4
Fuse (delayed action)	A	16
Open Circuit Voltage	V	100
Current Range	A	5-420
Duty Cycle at (40°C)	%100 %60 %40	270 / 340 / 420
Standards		<b>EN 60974-1 / EN 60974-10</b>
Protection Class	IP	23 S
Insulation Class		F
Dimensions ((L*W*H)	mm	500 / 220 / 425
Weight	kg	20

**STANDARD & OPTIONAL EQUIPMENTS**

This Order Code Covers The Welding Machine and All of The Equipments  <b>3021000054</b>					
	<b>1021000032</b>	<b>2020900647</b>	<b>2020900648</b>	<b>6051900088 (Optional)</b>	<b>6051300012 (Optional)</b>

GEDIK Welding provides full support for after sales services. 1 year warranty.



- Possible to weld with all electrodes with Ø 2.0 - Ø 5.0 mm in diameter
- Current adjustment using potentiometer with thyristor control
- Fan-cooling system and thermic protection
- Strong and durable enough to work under difficult and heavy conditions
- LIFT-TIG available



Input Voltage	V	3 Phase, 50/60 Hz, 380 V
Installed Power	kVA	15
Fuse (delayed action)	A	42
Open Circuit Voltage	V	38
Current Range	A	5-300
Duty Cycle at (40°C)	%100 %60 %35	180 / 230 / 300
Standards		<b>EN 60974-1 / EN 60974-10</b>
Protection Class	IP	23
Insulation Class		H
Dimensions ((L*W*H)	mm	680 / 510 / 460
Weight	kg	101

#### STANDARD & OPTIONAL EQUIPMENTS

This Order Code Covers The Welding Machine and All of The Equipments

3000900015



3020900105



2020900647



2020900648



6051900088  
(Optional)

GEDIK Welding provides full support for after sales services. 1 year warranty.



- Possible to weld with all electrodes up to  $\varnothing$  5.0 mm
- Current adjustment using potentiometer with thyristor control
- Digital current and voltage indicators
- Fan-cooling system and thermic protection
- Strong and durable enough to work under difficult and heavy conditions
- LIFT-TIG available
- Remote control available



Input Voltage	V	3 Phase, 50/60 Hz, 380 V
Installed Power	kVA	32
Fuse (delayed action)	A	63
Open Circuit Voltage	V	82
Current Range	A	5-450
Duty Cycle at (40°C)	%100 %60 %35	270 / 350 / 450
Standards	<b>EN 60974-1 / EN 60974-10</b>	
Protection Class	IP	23
Insulation Class	H	
Dimensions ((L*W*H)	mm	980 / 760 / 660
Weight	kg	209

### STANDARD & OPTIONAL EQUIPMENTS

This Order Code Covers The Welding Machine and All of The Equipments

3000900016



3020900108



2020900652



2020900653



6051900088  
(Optional)



6051900107  
(1000 A)  
6051900108  
(1250 A)  
(Optional)



1000900012  
(Optional)

GEDIK Welding provides full support for after sales services. 1 year warranty.





- Possible to weld with all electrodes up to  $\varnothing$  6.0 mm
- Possible to weld with cutting and gouging electrodes with  $\varnothing$  6.0 -  $\varnothing$  10.0 mm
- Current adjustment using potentiometer with thyristor control
- Digital current and voltage indicators
- Fan-cooling system and thermic protection
- Strong and durable enough to work under difficult and heavy conditions
- LIFT-TIG available
- Remote control available



Input Voltage	V	3 Phase, 50/60 Hz, 380 V
Installed Power	kVA	39
Fuse (delayed action)	A	63
Open Circuit Voltage	V	82
Current Range	A	50-650
Duty Cycle at (40°C)	%100 %60 %35	390 / 500 / 650
Standards	<b>EN 60974-1 / EN 60974-10</b>	
Protection Class	IP	23
Insulation Class	H	
Dimensions ((L*W*H)	mm	980 / 760 / 660
Weight	kg	265

### STANDARD & OPTIONAL EQUIPMENTS

This Order Code Covers The Welding Machine and All of The Equipments

3000900017



3020900109



2020900662



2020900661



6051900088  
(Optional)



6051900107  
(1000 A)  
6051900108  
(1250 A)  
(Optional)



1000900012  
(Optional)

GEDIK Welding provides full support for after sales services. 1 year warranty.



- Possible to weld with all electrodes up to  $\varnothing$  6.0 mm
- Possible to weld with cutting and gouging electrodes with  $\varnothing$  6.0 -  $\varnothing$  12.0 mm
- Current adjustment using potentiometer with thyristor control
- Digital current and voltage indicators
- Fan-cooling system and thermic protection
- Strong and durable enough to work under difficult and heavy conditions
- LIFT-TIG available
- Remote control available



Input Voltage	V	3 Phase, 50/60 Hz, 380 V
Installed Power	kVA	51
Fuse (delayed action)	A	80
Open Circuit Voltage	V	85
Current Range	A	5-800
Duty Cycle at (40°C)	%100 %60 %35	460 / 600 / 800
Standards		<b>EN 60974-1 / EN 60974-10</b>
Protection Class	IP	23
Insulation Class		H
Dimensions ((L*W*H)	mm	980 / 760 / 660
Weight	kg	297

### STANDARD & OPTIONAL EQUIPMENTS

This Order Code Covers The Welding Machine and All of The Equipments

3000900018



3020900112



2020900662



2020900661



6051900088  
(Optional)



6051900107  
(1000 A)  
6051900108  
(1250 A)  
(Optional)



1000900012  
(Optional)

GEDIK Welding provides full support for after sales services. 1 year warranty.



- Possible to weld with all electrodes including cellulosic up to Ø 6.0 mm
- Mechanically controlled
- Fan-cooling system and thermic protection
- Strong and durable enough to work under difficult conditions
- LIFT-TIG available



Input Voltage	V	3 Phase, 50/60 Hz, 380 V
Installed Power	kVA	32.5
Fuse (delayed action)	A	63
Open Circuit Voltage	V	75
Current Range	A	25-500
Duty Cycle at (40°C)	%100 %60 %35	300 / 380 / 500
Standards	<b>EN 60974-1 / EN 60974-10</b>	
Protection Class	IP	23
Insulation Class	H	
Dimensions ((L*W*H)	mm	810 / 610 / 650
Weight	kg	117

#### STANDARD & OPTIONAL EQUIPMENTS

This Order Code Covers The Welding Machine and All of The Equipments

3000900019



3020900113



2020900662



2020900661



6051900088  
(Optional)



6051900107  
(1000 A)  
6051900108  
(1250 A)  
(Optional)

GEDIK Welding provides full support for after sales services. 1 year warranty.

**Inverter**

- Precise and efficient TIG arc striking by high frequency
- Steady, easily targeted arc makes welding easy
- Low energy consumption and high efficiency
- Automatic compensation for mains voltage fluctuations within + %15 -%20
- Great voltage reserve increases ease of operation
- High performance on thin metal sheets
- Shock-proof fibre compound main structure
- Perform very well in MMA welding
- Single-Phase network
- Light weight and a compact size give better reach



		TIG	MMA
Input Voltage	V	1 Phase 220/230	50/60 Hz $\pm$ %15
Installed Power	kVA	7.2	7.9
Fuse (delayed action)	A	16	16
Open Circuit Voltage	V	88	88
Current Range	A	5-170	5-150
Duty Cycle at (40°C)	%100	95	95
	%60	115	115
	%20	170	150 (%25)
Standards		<b>EN 60974-1 / EN 60974-3 / EN 60974-10</b>	
Protection Class	IP	23 S	
Insulation Class		F	
Dimensions ((L*W*H)	mm	390 / 135 / 300	
Weight	kg	7	

**STANDARD & OPTIONAL EQUIPMENTS**

This Order Code Covers The Welding Machine and All of The Equipments

302100000



102100000



2020900723



6051900083



2020900723

GEDIK Welding provides full support for after sales services. 1 year warranty.



Inverter

- Standard equipped with pulse mode integrated into the control with available "EASY PULSE" facility
- Precise and efficient TIG arc striking by high frequency
- Steady, easily targeted arc makes welding easy
- Low energy consumption and high efficiency
- Automatic compensation for mains voltage fluctuations within +15% -20%, great voltage reserve increases ease of operation
- Digital control of all the welding parameters with the ability to store 9 personalised programs
- High performance on thin metal sheets
- Cycle and Pulse Functions improve welding productivity
- Perform very well in MMA welding, single - Phase network
- Light weight and a compact size give better reach



		TIG	MMA
Input Voltage	V	1 Phase 50/60 Hz, 230 V	
Installed Power	kVA	8.5	9.0
Fuse (delayed action)	A	20	20
Open Circuit Voltage	V	88	88
Current Range	A	5-200	5-160
Duty Cycle at (40°C)	%100	120	110
	%60	140	130
	%25	200	160 (%30)
Standards		<b>EN 60974-1 / EN 60974-3 / EN 60974-10</b>	
Protection Class	IP	23 S	
Insulation Class		F	
Dimensions ((L*W*H)	mm	390 / 135 / 300	
Weight	kg	7.5	

## STANDARD & OPTIONAL EQUIPMENTS

This Order Code Covers The Welding Machine and All of The Equipments

302100001



102100001



2020900723



6051900083



1051300003

GEDIK Welding provides full support for after sales services. 1 year warranty.

**Inverter**

- Digital adjustment of all the welding parameters
- Low curr Built-in innovative PFC Power Factor Correction
- Low energy consumption (-%30)
- High reliability when used with generator sets
- Suitable to be used with long mains cable
- Automatic compensation for mains voltage fluctuations within  $\pm$  %20
- Low pulse-high pulse (0,5 - 2000 Hz) and Synergic pulse mode functions
- Excellent welding characteristics in TIG and MMA with any type of electrodes
- Energy Saving function to operate the power source cooling fan and the torch water cooling only when necessary
- Possibility of activating the VRD function
- Possibility of memorizing welding parameters (7 JOBS)
- Use of up/down TIG torches will enable to adjust directly from the torch both welding parameters and memorized JOBS (optional)
- Auto-diagnostic feature for trouble shooting
- IP 23 protection class and dust-proof electronic components, thanks to the innovative "tunnel" fan cooling system, allow operation in the toughest work environments
- Compact water cooling equipment integrable with the power source (optional)



		TIG	MMA
Input Voltage	V	1 Phase 50/60 Hz, 230 V	
Installed Power	kVA	6.0	6.6
Fuse (delayed action)	A	16	16
Open Circuit Voltage	V	100	100
Current Range	A	5-220	5-180
Duty Cycle at (40°C)	%100	160	120
	%60	190	150
	%30	220	180
Standards		<b>EN 60974-1 / EN 60974-3 / EN 60974-10</b>	
Protection Class	IP	23 S	
Insulation Class		F	
Dimensions ((L*W*H)	mm	465 / 185 / 390	
Weight	kg	14	

## STANDARD & OPTIONAL EQUIPMENTS

This Order Code Covers The Welding Machine and All of The Equipments								
	3021000104	1021000084	2020900723	6051900083	1051300003	2020900179 (Optional)	6051300053 (Optional)	6051300012 (Optional)

GEDIK Welding provides full support for after sales services. 1 year warranty.



Inverter

- Digital ammeter and voltmeter with welding current presetting and hold function of the last read value
- Pulse welding allows a better arc control and less deformation of the workpiece (0,5-2000Hz)
- Welding pulse mode selector switch: Syn=Easy-Fast-Ultra Fast-Slow pulse function
- Energy saving function to operate the power source cooling fan and the torch water cooling only when necessary
- Arc Force-hot start and electrode Antisticking function for best MMA Welding
- Electromagnetic disturbance reduction because of high frequency used at arc striking only.
- Personalised welding program storing and recalling
- Mains voltage fluctuation automatic compensation within  $\pm$  %20
- Welding mode selector switch: 2T/4T - Cycle-Spot Timer
- Digital adjustment of all the welding parameters
- VRD device reduces the open circuit voltage to values below 12V, possibility of activating the VRD function
- Use of special TIG torches will enable the remote control of the welding parameters directly from the torch



		TIG	MMA
Input Voltage	V	3 Phase 50/60 Hz,	400 V 15/-20%
Installed Power	kVA	7	9.6
Fuse (delayed action)	A	10	10
Open Circuit Voltage	V	60	60
Current Range	A	5-260	5-260
Duty Cycle at (40°C)	%100	200	190
	%60	230	220
	%30	260	250
Standards		<b>EN 60974-1 / EN 60974-3 / EN 60974-10</b>	
Protection Class	IP	23 S	
Insulation Class		H	
Dimensions ((L*W*H)	mm	500 / 220 / 425	
Weight	kg	16	

## STANDARD & OPTIONAL EQUIPMENTS

This Order Code Covers The Welding Machine and All of The Equipments  
**3021000004**  
 Air Cooled  
**3021000005**  
 Water Cooled



1021000003



6051900083



2020900649



1051300003



1024300004



2020900179 (Optional)



6051900076 (Optional)



6051300053 (Optional)



6051300012 (Optional)

GEDIK Welding provides full support for after sales services. 1 year warranty.



- Compact size and light weight
- Instantaneous arc starts and stable arc
- User friendly operations
- Cope with dust and sudden rain
- Light weight and compact size
- Automatic compensation for mains voltage fluctuations within  $\pm 15\%$
- Perform very well in MMA welding
- 3 phase network
- Current increase and decrease by single / double clicking of the standard torch switch
- Pulse welding allows a better arc control and less deformation of the work piece (0,1-500 Hz)
- Personalised welding rogram starring and recoiling

Inverter



		TIG	MMA
Input Voltage	V	3 Phase 50/60 Hz, 400 V $\pm$ 15	
Installed Power	kVA	11	9
Fuse (delayed action)	A	32	32
Open Circuit Voltage	V	58	58
Current Range	A	4-300	10-250
Duty Cycle at (40°C)	%100	190	158
	%60	245	204
	%30	300	250
Standards		<b>EN 60974-1 / EN 60974-3 / EN 60974-10</b>	
Protection Class	IP	23 S	
Insulation Class		H	
Dimensions ((L*W*H)	mm	640 / 250 / 370	
Weight	kg	30	

## STANDARD & OPTIONAL EQUIPMENTS

This Order Code Covers The Welding Machine and All of The Equipments  
**3021000008**  
 Air Cooled  
**3021000009**  
 Water Cooled



1021000005



6051900083



2020900649



1051300003



2020900175  
(Optional)



1024300000  
(Optional)



6051900076  
(Optional)

GEDIK Welding provides full support for after sales services. 1 year warranty.





Inverter

- Digital ammeter and voltmeter with welding current presetting and hold function of the last read value
- Pulse welding allows a better arc control and less deformation of the workpiece (0,5-2000Hz)
- Welding pulse mode selector switch: Syn=Easy-Fast-Ultra Fast-Slow pulse function
- Energy saving function to operate the power source cooling fan and the torch water Cooling only when necessary
- Arc Force-hot start and electrode Antisticking function for best MMA Welding
- Electromagnetic disturbance reduction because of high frequency used at arc striking only
- Personalised welding program storing and recalling
- Mains voltage fluctuation automatic compensation within  $\pm 20\%$
- Welding mode selector switch: 2T/4T - Cycle-Spot Timer
- Digital adjustment of all the welding parameters
- VRD device reduces the open circuit voltage to values below 12V, possibility of activating the VRD function
- Use of special TIG torches will enable the remote control of the welding parameters directly from the torch



		TIG	MMA
Input Voltage	V	3 Phase 50/60 Hz, 400 V+ 15/-20%	
Installed Power	kVA	9.1	9.8
Fuse (delayed action)	A	10	10
Open Circuit Voltage	V	100	100
Current Range	A	5-300	10-270
Duty Cycle at (40°C)	%100	210	200
	%60	250	230
	%30	300	270
Standards		<b>EN 60974-1 / EN 60974-3 / EN 60974-10</b>	
Protection Class	IP	23 S	
Insulation Class		H	
Dimensions ((L*W*H)	mm	465 / 185 / 390	
Weight	kg	17.5	

## STANDARD & OPTIONAL EQUIPMENTS

This Order Code Covers The Welding Machine and All of The Equipments  
**3021000006**  
 Air Cooled  
**3021000007**  
 Water Cooled



1021000004



6051900083



2020900649



1051300003



1024300004 (Optional)



2020900179 (Optional)



6051900076 (Optional)



6051300053 (Optional)



6051300012 (Optional)

GEDIK Welding provides full support for after sales services. 1 year warranty.



Inverter

- Digital ammeter and voltmeter with welding current presetting and hold function of the last read value
- Pulse welding allows a better arc control and less deformation of the workpiece (0,5-2000Hz)
- Welding pulse mode selector switch: Syn=Easy-Fast-Ultra Fast-Slow pulse function
- Energy saving function to operate the power source cooling fan and the torch water Cooling only when necessary
- Arc Force-hot start and electrode Antisticking function for best MMA Welding
- Electromagnetic disturbance reduction because of high frequency used at arc striking only
- Personalised welding program storing and recalling
- Mains voltage fluctuation automatic compensation within  $\pm 20$
- Welding mode selector switch: 2T/4T -Cycle-Spot Timer
- Digital adjustment of all the welding parameters
- VRD device reduces the open circuit voltage to values below 12V, possibility of activating the VRD function
- Use of special TIG torches will enable the remote control of the welding parameters directly from the torch



Input Voltage	V	3 Phase 50/60 Hz, 400 V + 15/-20%
Installed Power	kVA	13.3
Fuse (delayed action)	A	16
Open Circuit Voltage	V	100
Current Range	A	5-420
Duty Cycle at (40°C)	%100 %60 %40	270 / 340 / 420
Standards		<b>EN 60974-1 / EN 60974-3 / EN 60974-10</b>
Protection Class	IP	23 S
Insulation Class		F
Dimensions ((L*W*H)	mm	560 / 220 / 425
Weight	kg	25

## STANDARD & OPTIONAL EQUIPMENTS

This Order Code Covers The Welding Machine and All of The Equipments  
**3021000010**  
 Air Cooled  
**3021000011**  
 Water Cooled



1021000006



6051900083



2020900649



1051300003



1024300004  
(Optional)



2020900179  
(Optional)



6051900076  
(Optional)



6051300053  
(Optional)



6051300012  
(Optional)

GEDIK Welding provides full support for after sales services. 1 year warranty.



- Large-capacity 500 A current output achieves high-efficiency welding.
- Current setting can be made in increments of 0.1 A in the current region of 10 A or less, thus making it possible to set ideal welding conditions to ultra thin plates
- Synergistic function makes automatic setting of welding conditions. (diameter of electrode, material of base metal, shape of weld joint and thickness of base metal)
- Pulse function (0.1-999 Hz) provides high performance in thin materials.
- Ability to store the parameters
- Easy to adjust parameters such as pre-gas / post-gas, up-slope / down- slope, initial current / final current, crater filling-arc spot time etc
- Newly developed tunnel protection and due to the revolution control of the cooling fan according to its duty cycle or ambient air temperature, the design prevents dust from entering the area where electronic components are installed
- Data editing / copying / transferring, using USB via machine front panel
- Unique wire feeding advantages via three wire straighteners and four feed rollers
- Easy connection to Automation & Robotic Systems
- Ease of control of the machine current using a standard torch without the need for high - cost torches with special control
- Optionally, monitoring of welding data from android mobile phone, tablet or PC, graphical welder test, amount of wire consumption, working time, recording of WPS work and print out etc
- Technological advantages



		TIG	MMA
Input Voltage	V	3 Phase 50/60 Hz, 400 V	
Installed Power	kVA	19.3	18.2
Fuse (delayed action)	A	32	32
Open Circuit Voltage	V	74	74
Current Range	A	1-500	310-500
Duty Cycle at (40°C)	%100	387	310
	%60	500	500
Standards		<b>EN 60974-1 / EN 60974-3 / EN 60974-10</b>	
Protection Class	IP	IP 23	
Insulation Class		F	
Dimensions ((L*W*H)	mm	395 / 710 / 592	
Weight	kg	62	

## STANDARD & OPTIONAL EQUIPMENTS

This Order Code Covers The Welding Machine and All of The Equipments <b>3021000012</b> Air Cooled <b>3021000013</b> Water Cooled								
	1021000007	6051900083	2020900660	1051300003	1045000000 (Optional)	2020900174 (Optional)	6051900076 (Optional)	6051300053 (Optional)

GEDIK Welding provides full support for after sales services. 1 year warranty.



Inverter

- Suitable for all weldable materials and all types of current
- Precise and efficient TIG arc striking by high frequency
- Standard equipped with pulse mode integrated into the control with available "easy-pulse" facility
- Low energy consumption and high efficiency
- Automatic compensation for mains voltage fluctuations within + %15 - %20
- High performance on thin metal sheets
- Very good MMA welding characteristics with any type of electrodes
- Single - Phase network



		TIG	MMA
Input Voltage	V	1 Phase, 50/60 Hz, 220 V	
Installed Power	kVA	5.4	6.3
Fuse (delayed action)	A	16	16
Open Circuit Voltage	V	100	100
Current Range	A	5-220	5-180
Duty Cycle at (40°C)	%100	140	120
	%60	180	150
	%30	220	180
Standards		EN 60974-1 / EN 60974-3 / EN 60974-10	
Protection Class	IP	23 S	
Insulation Class		H	
Dimensions ((L*W*H)	mm	465 / 185 / 390	
Weight	kg	15.5	

## STANDARD & OPTIONAL EQUIPMENTS

This Order Code Covers The Welding Machine and All of The Equipments  
**3021000014**  
 Air Cooled  
**3021000015**  
 Water Cooled



1021000008



6051900083



2020900723



1051300003



1024300005 (Optional)



2020900179 (Optional)



6051900076 (Optional)



6051300053 (Optional)



6051300012 (Optional)

GEDIK Welding provides full support for after sales services. 1 year warranty.



Inverter

- Easily regulate current via hand torch switch
- Improve quality at every welding place through a wide variety of welding modes
- Improve welding performance of thin plates with silent pulse function
- Improved arc concentration allows for better workability fillet and butt welding
- Light weight and compact size
- Automatic compensation for mains voltage fluctuations within  $\pm 15\%$
- Perform very well in MMA welding
- 3 phase network
- Current increase and decrease by single/double clicking of the standard torch switch
- Pulse welding allows a better arc control and less deformation of the workpiece
- AC/DC (MIX) pulse welding with (0,1-500Hz) (0,1-50Hz)
- It can be connection to PLC and automation systems



		TIG	MMA
Input Voltage	V	3 Phase 50/60 Hz, 400 V $\pm$ 15	
Installed Power	kVA	11	9
Fuse (delayed action)	A	32	32
Open Circuit Voltage	V	58	58
Current Range	A	4-300	10-250
Duty Cycle at (40°C)	%100	190	158
	%60	245	204
	%40	300	250
Standards		EN 60974-1 / EN 60974-3 / EN 60974-10	
Protection Class	IP	23 S	
Insulation Class		H	
Dimensions ((L*W*H)	mm	640 / 250 / 370	
Weight	kg	30	

## STANDARD & OPTIONAL EQUIPMENTS

This Order Code Covers The Welding Machine and All of The Equipments  
**3021000018**  
 Air Cooled  
**3021000019**  
 Water Cooled



1021000010



6051900083



2020900649



1051300003



1024300000  
(Optional)



2020900174  
(Optional)



6051900076  
(Optional)



6051300053  
(Optional)

GEDIK Welding provides full support for after sales services. 1 year warranty.



Inverter

- Digital ampermeter and voltmeter with welding current presetting and hold function of the last read value
- Pulse welding allows a better arc control and less deformation of the workpiece (0,5-2000Hz)
- Welding pulse mode selector switch: Syn=Easy-Fast-Ultra Fast-Slow pulse function
- Energy saving function to operate the power source cooling fan and the torch water cooling only when necessary
- Arc Force-hot start and electrode Antisticking function for best MMA Welding
- AC square wave balance and balance plus, AC square wave frequency adjustment
- Wave selector: Square-Mixed-Sinusoidal-Triangular
- Tungsten electrode diameter presetting for a better control of the arc striking and arc dynamics
- Personalised welding program storing and recalling
- Main voltage fluctuation automatic compensation within  $\pm 20\%$
- Welding mode selector switch: 2T/4T - Cycle - Spot Timer
- Digital adjustment of all the welding parameters
- VRD device reduces the open circuit voltage to values below 12V, possibility of activating
- Use of special TIG torches will enable the remote control of the welding parameters directly from the torch (optional)



		TIG	MMA
Input Voltage	V	3 Phase 50/60 Hz, 400 V $\pm$ 20	
Installed Power	kVA	9.6	9
Fuse (delayed action)	A	10	32
Open Circuit Voltage	V	100	58
Current Range	A	5-300	10-250
Duty Cycle at (40°C)	%100	210	158
	%60	250	204
	%40	300	250
Standards		<b>EN 60974-1 / EN 60974-3 / EN 60974-10 / S</b>	
Protection Class	IP	23 S	
Insulation Class		H	
Dimensions ((L*W*H)	mm	465 / 185 / 390	
Weight	kg	19	

## STANDARD & OPTIONAL EQUIPMENTS

This Order Code Covers The Welding Machine and All of The Equipments  
**3021000105**  
 Air Cooled  
**3021000017**  
 Water Cooled



GEDIK Welding provides full support for after sales services. 1 year warranty.



Inverter

- Digital ampermeter and voltmeter with welding current presetting and hold function of the last read value
- Pulse welding allows a better arc control and less deformation of the workpiece (0,5-2000Hz)
- Welding pulse mode selector switch: Syn=Easy-Fast-Ultra Fast-Slow pulse function
- Energy saving function to operate the power source cooling fan and the torch water Cooling only when necessary
- Arc Force-hot start and electrode
- Antisticking function for best MMA Welding
- AC square wave balance and balance plus, AC square wave frequency adjustment
- Wave selector: Square-Mixed-Sinusoidal-Triangular
- Tungsten electrode diameter presetting for a better control os the arc striking and arc Dynamics
- Personalised welding program storing and recalling
- Mains voltage fluctuation automatic compensation within  $\pm 20\%$
- Welding mode selector switch: 2T/4T-Cycle-Spot Timer
- Digital adjustment of all the welding parameters
- VRD device reduces the open circuit voltage to values below 12V, possibility of activating
- Use of special TIG torches will enable the remote control of the welding parameters directly from the torch (optional)



		TIG	MMA
Input Voltage	V	3 Phase 50/60 Hz, 400 V $\pm 20\%$	
Installed Power	kVA	15.3	19.9
Fuse (delayed action)	A	16	16
Open Circuit Voltage	V	65	65
Current Range	A	5-400	5-400
Duty Cycle at (40°C)	%100	250	250
	%60	320	320
	%35	400	400
Standards		<b>EN 60974-1 / EN 60974-3 / EN 60974-10 / S</b>	
Protection Class	IP	23 S	
Insulation Class		H	
Dimensions ((L*W*H)	mm	640 / 290 / 525	
Weight	kg	49	

## STANDARD & OPTIONAL EQUIPMENTS

This Order Code Covers The Machine and All of The Equipments  
**3021000020**  
 Air Cooled  
**3021000021**  
 Water Cooled



1021000069



6051900083



2020900649



1051300003



1024300003 (Optional)



2020900179 (Optional)



6051900076 (Optional)



6051300053 (Optional)



6051300012 (Optional)

GEDIK Welding provides full support for after sales services. 1 year warranty.



Inverter

- Digital adjustment of all the welding parameters
- Pulse welding allows a better arc control and less deformation of the workpiece
- Standard equipped with pulse mode integrated into the control with available "Easy Pulse" facility
- Energy saving function to operate the power source cooling fan and the torch water Cooling only when necessary
- Arc Force-hot start and electrode
- Antisticking function for best MMA Welding
- Wave selector: Square-Mixed-Sinusoidal
- AC square wave balance and balance plus, AC square wave frequency adjustment
- Tungsten electrode diameter presetting for a better control on the arc striking and arc Dynamics
- Personalised welding program storing and recalling
- Mains voltage fluctuation automatic compensation within  $\pm 20\%$
- Welding mode selector switch: 2T/4T -Cycle-Spot Timer.
- Use of special TIG torches will enable the remote control of the welding parameters directly from the torch.(optional)



Input Voltage	V	3 Phase 50/60 Hz, 400 V $\pm 20\%$
Installed Power	kVA	17.9
Fuse (delayed action)	A	16
Open Circuit Voltage	V	70
Current Range	A	10-500
Duty Cycle at (40°C)	%100 %60 %35	310 / 400 / 500
Standards		<b>EN 60974-1 / EN 60974-3 / EN 60974-10 / S</b>
Protection Class	IP	23 S
Insulation Class		H
Dimensions ((L*W*H)	mm	715 / 290 / 525
Weight	kg	53

## STANDARD & OPTIONAL EQUIPMENTS

This Order Code Covers The Welding Machine and All of The Equipments  
**3021000022**  
 Air Cooled  
**3021000023**  
 Water Cooled



1021000012



6051900083



2020900660



1051300003



1024300003 (Optional)



2020900176 (Optional)



6051900076 (Optional)



6051300053 (Optional)



6051300012 (Optional)

GEDIK Welding provides full support for after sales services. 1 year warranty.





Inverter

- Multifunction power source with optimal welding characteristics in MIG/MAG, MMA and TIG
- Digital adjustments of all the welding parameters
- Arc Force-hot start and electrode
- Antisticking function for best MMA Welding
- Ability to store personalized welding parameters up to 99 JOBS
- Selector for Current, wire speed, material thickness and program
- Built in polarity change over facility for most common gas and gasless wires
- It is absolutely unique for all external or internal maintenance jobs, car body repairs, agriculture and very light fabrication works
- Wire spool lodging up to Ø 200 mm max
- Possibility of utilizing Ø 300 mm coils by means of the Retrofit Kit (Optional)
- Professional 2-roll wire feeding mechanism for a precise and constant wire driving
- Welding "mode" selector; 2T/4T - initial & crater - spot timer - stitch timer function
- VRD (Voltage Reduction Device) function
- Central Euro connection for the torch



		MIG/MAG	TIG	MMA
Input Voltage	V	1 Phase 220/230 50/60 Hz ± %15		
Installed Power	kVA	7.8	5.9	7.4
Fuse (delayed action)	A	16	16	16
Open Circuit Voltage	V	59	59	59
Current Range	A	10-175	10-175	10-150
Duty Cycle at (40°C)	%100	100	100	90
	%60	115	115	110
	%X	175 (%20)	175 (%20)	150 (%25)
Usable Wire Diameters		0.6-1.0	---	---
Standards		<b>EN 60974-1 / EN 60974-5 / EN 60974-10 / S</b>		
Protection Class	IP	23 S		
Insulation Class		H		
Dimensions ((L*W*H)	mm	500 / 220 / 425		
Weight	kg	16		

## STANDARD & OPTIONAL EQUIPMENTS

This Order Code Covers The Welding Machine and All of The Equipments 3021000024								
	1021000013	1051900009	2020900723	1051300003	1024300003 (Optional)	6051900088 (Optional)	2020901000 (Optional)	2020900176 (Optional)

GEDIK Welding provides full support for after sales services. 1 year warranty.



- High Quality Welding in low current range
- Penetration Adjustment Function, contributes to the stabilization of the welding quality
- Digital Electronic Reactor Control which supports high quality welding
- DC classic and DC synergic welding method
- Instant current adjustment function on the torch
- Pre/post-gas time, initial current, up/down slope current time etc. parameters
- Detachable wire feeding unit (4+3 rolling system for greater welding torch flexibility)
- Substantially improved the instantaneous arc starts by digital turbo start function and digital antistick
- Setting of job memory fine adjustment (30 Jobs)
- Current increase and decrease by single / double clicking of the standard torch switch

Inverter



Input Voltage	V	3 Phase, 50/60 Hz, 400 ± 15 V
Installed Power	kVA	17.1
Fuse (delayed action)	A	62
Open Circuit Voltage	V	58
Current Range	A	30-380
Current Tension Range	V	12-36
Duty Cycle at (40°C)	%100 %60 %50	270 / 350 / 380
Standards		<b>EN 60974-1 / EN 60974-5 / EN 60974-10 / S</b>
Protection Class	IP	23
Insulation Class		H
Dimensions ((L*W*H)	mm	640 / 250 / 430
Weight	kg	30

### WIRE FEEDER UNIT

Wire Feeder Units		CM-7401
WireTypes		Fe / FC
Usable Wire Diameters	Ø mm	0.8 / 1.0 / 1.2
Wire Feeding Speed	mt/min.	22 max.
Dimensions ((L*W*H)	mm	732 / 243 / 402
Weight	kg	16

### STANDARD & OPTIONAL EQUIPMENTS

This Order Code Covers The Welding Machine and All of The Equipments  
**3021000025**  
 Air Cooled  
**3021000026**  
 Water Cooled



1021000014



1024400000



1024300000 (Optional)



2020900174



1051900030



2020900649



1051300003



6000000441 (Optional)



6064100002 (Optional)



2020900878

GEDIK Welding provides full support for after sales services. 1 year warranty.



Inverter

- MIG- MAG / MMA (Electric Arc Welding) / TIG-Lift (Argon) multiprocess functions
- Excellent software optimized for coated materials such as galvanized.
- Memory function for 100 parameters
- Easy to adjust parameters such as pre-gas / post-gas, up-slope / down-slope, initial current / final current, crater filling - are spot time etc
- When the stick out is changable and long, constant function eliminate the disadvantages
- Newly developed tunnel protection and due to the revolution control of cooling fan according to its duty cycle or ambient air temperature, the design prevents dust from entering the area where electronic components are installed
- Data editing / copying / transferring, using USB via machine front panel
- Unique wire feeding advantages via three wire straighteners and four feed rollers
- Interface board is located in the machine as a standart, which provides an easy connection to PLC, Automation & Robotie Systems
- Ease of control of the machine current using a standard torch without the need for high-cost torches with special control
- Optionally, monitoring of welding data from android mobile phone, tablet or PC, graphical welder test, amount of wire consumption, working time, recording of WPS work and print out etc. Technological advantages



Input Voltage	V	3 Phase, 50/60 Hz, 400 ± 15 V
Installed Power	kVA	17.7
Fuse (delayed action)	A	25
Open Circuit Voltage	V	70
Current Range	A	30-400
Current Tension Range	V	12-34
Duty Cycle at (40°C)	%50	400
Standards		<b>EN 60974-1 / EN 60974-5 / EN 60974-10 / S</b>
Protection Class	IP	23
Insulation Class		H
Dimensions ((L*W*H)	mm	395 / 710 / 592
Weight	kg	62

### WIRE FEEDER UNIT

Wire Feeder Units		CM-7403A-D
Wire Types		Fe / FC Aluminum
Usable Wire Diameters	Ø mm	0.8/0.9/1.0/1.2/1.4/1.6 1.0/1.2/1.6
Wire Feeding Speed	mt/min.	22 max.
Dimensions ((L*W*H)	mm	710 / 240 / 395
Weight	kg	17

### STANDARD & OPTIONAL EQUIPMENTS

<small>This Order Code Covers The Welding Machine and All of The Equipments</small>										
3021000027	1021000015	1024400000	1051900031	2020900649	1051300003	1045000000	2020900878	2020900174	6000000441 (Optional)	6064100002 (Optional)

GEDIK Welding provides full support for after sales services. 1 year warranty.



Inverter

- MIG- MAG / MMA (Electric Arc Welding) / TIG-Lift (Argon) multiprocess functions
- With possibility 'Low even Spatter' using pure function CO<sub>2</sub> in and thin and mixtures medium gas. thickness materials, %80 non-spatter and stabilized welding
- Excellent software optimized for coated materials such as galvanized
- Memory function for 100 parameters
- Easy filling-are to spot adjust time etc. parameters such as pre-gas / post-gas, up-slope / down-slope, initial current/final current, crater
- When the stick out is changable and long, constant function eliminate the disadvantages
- Newly nt air developed temperature, tunnel the protection design and due prevents to the dust from revolution entering control the of area cooling where fan electronic according to its components duty cycle are or installed ambie
- Data editing / copying / transferring, using USB via machine front panel
- Unique wire feeding advantages via three wire straighteners and four feed rollers
- Interface board is located in the machine as a standart, which provides an easy connection to PLC, Automation & Robotic Systems
- Ease of control of the machine current using a standard torch without the need for high-cost torches with special control
- Optionally, consumption, monitoring of working welding time, data recording from of android WPS work mobile and phone, print out tablet etc.



Input Voltage	V	3 Phase, 50/60 Hz, 400 ± 15 V
Installed Power	kVA	18.2
Fuse (delayed action)	A	32
Open Circuit Voltage	V	70
Current Range	A	30-400
Current Tension Range	V	12-34
Duty Cycle at (40°C)	%50	400
Standards		EN 60974-1 / EN 60974-5 / EN 60974-10 / S
Protection Class	IP	23
Insulation Class		H
Dimensions ((L*W*H)	mm	395 / 710 / 592
Weight	kg	62

### WIRE FEEDER UNIT

Wire Feeder Units		CM-7403A-D
WireTypes		Fe / FC Aluminum
Usable Wire Diameters	Ø mm	0.8 / 0.9 / 1.0 / 1.2 / 1.4 / 1.6 1.0 / 1.2 / 1.6
Wire Feeding Speed	mt/min	22 max.
Dimensions ((L*W*H)	mm	710 / 240 / 395
Weight	kg	17

### STANDARD & OPTIONAL EQUIPMENTS

This Order Code Covers The Welding Machine and All of The Equipments										
	3021000028	1021000016	1024400000	1051900031	2020900649	1051300003	1045000000	2020900878	2020900174	600000441 (Optional)

GEDIK Welding provides full support for after sales services. 1 year warranty.



Inverter

- MIG- MAG / MMA (Electric Arc Welding) / TIG-Lift (Argon) multiprocess functions
- At %100 500 A current output achieves high-efficiency welding
- Excellent software optimized for coated materials such as galvanized
- Memory function for 100 parameters
- Easy to adjust parameters such as pre-gas/post-gas, up-slope / down-slope, initial current / final current, crater filling-arc spot time etc
- When the stick out is changeable and long, constant function eliminates the disadvantages
- Newly developed tunnel protection and due to the revolution control of cooling fan according to its duty cycle or ambient air temperature, the design prevents dust from entering the area where electronic components are installed
- Data editing / copying / transferring, using USB via machine front panel
- Unique wire feeding advantages via three wire straighteners and four feed rollers.
- Interface board is located in the machine as a standard, which provides an easy connection to PLC, Automation & Robot Systems
- Ease of control of the machine current using a standard torch without the need for high-cost torches with special control
- Optionally, monitoring of welding data from android mobile phone, tablet or PC, graphical welder test, amount of wire consumption, working time, recording of WPS work and print out etc. Technological advantages



Input Voltage	V	3 Phase, 50/60 Hz, 400 ± 15 V
Installed Power	kVA	23.6
Fuse (delayed action)	A	34
Open Circuit Voltage	V	70
Current Range	A	30-550
Current Tension Range	V	12-39
Duty Cycle at (40°C)	%100	500
Standards		<b>EN 60974-1 / EN 60974-5 / EN 60974-10 / S</b>
Protection Class	IP	23
Insulation Class		H
Dimensions ((L*W*H)	mm	395 / 710 / 762
Weight	kg	80

### WIRE FEEDER UNIT

Wire Feeder Units		CM-7403A-D
WireTypes		Fe / FC Aluminum
Usable Wire Diameters	Ø mm	0.8 / 0.9 / 1.0 / 1.2 / 1.4 / 1.6 1.0 / 1.2 / 1.6
Wire Feeding Speed	mt/min	22 max.
Dimensions ((L*W*H)	mm	710 / 240 / 395
Weight	kg	17

### STANDARD & OPTIONAL EQUIPMENTS

This Order Code Covers The Welding Machine and All of The Equipments										
	3021000029	1021000017	1024400000	1051900031	2020900683	1051300003	1045000000	2020900878	2020900174	6000000441 (Optional)

GEDIK Welding provides full support for after sales services. 1 year warranty.



**Inverter**

- Multiprocess: MIG PULSE, MIG/MAG Synergic, MIG/MAG Manual, MMA and LIFT TIG
- Digital control of all welding parameters with preset synergic curves according to used material, gas and wire diameter
- User friendly and easy-to-use selection and recalling of the parameters and welding programs
- Ability to store personalized welding parameters up to 99 JOBS.
- Built-in polarity changeover facility for most common gas and glassless wires
- Professional wire feeding mechanism
- Double groove rolls replaceable without any tool
- Energy Saving: fan on demand
- Possibility of utilizing Ø 300 mm coils by means of the Retrofit Kit (Optional).
- Welding "mode" selector; 2T/4T-initial & crater - spot timer stitch timer function
- VRD(Voltage Reduction Device) function
- Central Euro connection for the torch



		MIG/MAG	TIG	MMA
Input Voltage	V	1 Phase 220 / 230	50 / 60 Hz ± 15%	
Installed Power	kVA	5.1	3.9	5.6
Fuse (delayed action)	A	16	16	16
Open Circuit Voltage	V	59	59	59
Current Range	A	10-200	5-175	10-150
Duty Cycle at (40°C)	%100	100	100	90
	%60	115	115	110
	%X	200 (%15)	175 (%20)	150 (%25)
Usable Wire Diameters		0.6-1.0	---	---
Standards		<b>EN 60974-1 / EN 60974-5 / EN 60974-10 / S</b>		
Protection Class	IP	23 S		
Insulation Class		H		
Dimensions ((L*W*H)	mm	500 / 220 / 425		
Weight	kg	16		

### STANDARD & OPTIONAL EQUIPMENTS

This Order Code Covers The Welding Machine and All of The Equipments								
3021000031	1021000019	1051900033	2020900649	1051300003	3030100028 (Optional)	6051900088 (Optional)	2020901000 (Optional)	2020900176 (Optional)

Gedik Welding provides full support for after sales services. 1 year warranty.



Inverter

- Digital control of the welding parameters with synergic curves preset according to used type of material, gas and wire diameter
- Synergic multiprocess inverter compact power equipment
- Ability to store personalized welding parameters up to 99 JOBS
- "Smart PROGRAM" key for quickly selecting any program
- Feeding mechanism with 4 rolls of large diameter for a precise and constant wire driving
- Double groove rolls replaceable without any tool
- "Energy saving" function to operate the power source cooling fan and torch water cooling only when necessary
- Excellent arc striking always precise and efficient
- Ability to partially or totally lock the equipment with access key by password
- Reduced energy consumption
- Trouble shooting auto-diagnosis feature
- Initial and final crater control
- VRD - Voltage Reduction Device
- Vision Arc
- Vision Pulse
- Vision Double Pulse



		MIG/MAG	TIG	MMA
Input Voltage	V	3 Phase 220/230 50/60 Hz ± 15%		
Installed Power	kVA	10	8.5	11
Fuse (delayed action)	A	16	10	16
Open Circuit Voltage	V	60	60	60
Current Range	A	10-250	5-250	10-250
Duty Cycle at (40°C)	%100	180	180	180
	%60	200	200	200
	%35	250	250	250
Usable Wire Diameters		0.6-1.2	---	---
Standards		<b>EN 60974-1 / EN 60974-5 / EN 60974-10</b>		
Protection Class	IP	23		
Insulation Class		H		
Dimensions ((L*W*H)	mm	650 / 300 / 388		
Weight	kg	21		

### STANDARD & OPTIONAL EQUIPMENTS

This Order Code Covers The Welding Machine and All of The Equipments

**3021000032**  
Air Cooled  
**3021000033**  
Water Cooled



1021000071



1051900010



2020900723



1051300003



1051900012  
(Optional)



6051900088  
(Optional)



1024300003  
(Optional)



2020900176  
(Optional)



- Based on high quality inverter technology
- DC Pulse MIG / MAG and CO<sub>2</sub> / MAG / MIG
- Optional Wave pulse feature
- MMA & LIFT TIG available
- Compact, reliable light design
- Excellent pulse performance
- Four-Roll Encoder Wire feeder
- Incredible quality of welding achievable on galvanized steel
- Arc stability at very high welding speeds
- With the optional software achieve high quality welding on such as Magnesium & Titanium
- Current increase and decrease by single/double clicking of the standard torch switch



Input Voltage	V	3 Phase, 50/60 Hz, 400 ± 15 V
Installed Power	kVA	13.6
Fuse (delayed action)	A	32
Open Circuit Voltage	V	81
Current Range	A	30-300
Current Tension Range	V	12-30
Duty Cycle at (40°C)	%100 %60 %40	170 / 220 / 270
Standards		<b>EN 60974-1 / EN 60974-5 / EN 60974-10 / S</b>
Usable Wire Types		Fe / Al / SS / Cu
Usable Wire Diameters	Ø mm	0.8/0.9/1.0/1.2
Protection Class	IP	23
Insulation Class		H
Dimensions ((L*W*H)	mm	640 / 300 / 600
Weight	kg	30

## STANDARD & OPTIONAL EQUIPMENTS

This Order Code Covers The Welding Machine and All of The Equipments  
**3021000034**  
 Air Cooled  
**3021000035**  
 Water Cooled



1021000020



1051900030



2020900649



1051300003



2020900005



1024300001  
(Optional)



2020900174  
(Optional)



1051900031  
(Optional)

Gedik Welding provides full support for after sales services. 1 year warranty.



**Inverter**

- Digital control of the welding parameters with synergic curves preset according to used type of material, gas and wire diameter
- Multiprocess power sources: MMA/TIG LIFT/ - MIG/MAG Synergic & Manual-Pulse and double Pulse
- Synergic multiprocess inverter compact power equipment
- Ability to store personalized welding parameters up to 99 JOBS
- " Smart PROGRAM" key for quickly selecting any program
- Feeding mechanism with 4 rolls of large diameter for a precise and constant wire driving
- Double groove rolls replaceable without any tool
- "Energy saving" function to operate the power source cooling fan and torch water cooling only when necessary
- Excellent arc striking always precise and efficient
- Ability to partially or totally lock the equipment with access key by password
- Reduced energy consumption
- Trouble shooting auto-diagnosis feature
- Initial and final crater control
- VRD - Voltage Reduction Device

**Standart package:**

Fe - CrNi - AlMg - AIS

**Optional package:**

 Fe - CrNi - AlMg - AlSi - CuSi3 - AlBz8 - FCW (Rutil - Basic - Metal)  
 Duplex - Super Duplex

Input Voltage	V	3 Phase, 50/60 Hz, 400 ± 20 V
Installed Power	kVA	17
Fuse (delayed action)	A	25
Open Circuit Voltage	V	63
Current Range	A	10-320
Duty Cycle at (40°C)	%100 %60 %40	280 / 300 / 320
Standards	<b>EN 60974-1 / EN 60974-5 / EN 60974-10</b>	
Usable Wire Diameters	0.6 - 1.2	
Protection Class	IP	23 S
Insulation Class	H	
Dimensions ((L*W*H)	mm	660 / 290 / 515
Weight	kg	42

 Vision Pipe  
(Optional)

 Vision Ultraspeed  
(Optional)

 Vision Cold  
(Optional)

 Vision Power  
(Optional)

**STANDARD & OPTIONAL EQUIPMENTS**

 This Order Code  
 Covers The  
 Welding Machine  
 and All of The  
 Equipments  
**3021000036**  
 Air Cooled  
**3021000037**  
 Water Cooled

**1021000021**

**1051900011**

**2020900649**

**1051300003**

**1024300001**  
 (Optional)

**2020900176**  
 (Optional)

**1051900012**  
 (Optional)

**Inverter**

- Digital control of the welding parameters with synergic curves preset according to used type of material, gas and wire diameter
  - Multiprocess power sources: MMA/LIFT TIG / MIG/MAG Synergic & Manual-Pulse and Double Pulse
  - Synergic multiprocess inverter compact power equipment
  - Ability to store personalized welding parameters up to 99 JOBS
  - "Smart PROGRAM" key for quickly selecting any program
  - Feeding mechanism with 4 rolls of large diameter for a precise and constant wire driving
  - Double groove rolls replaceable without any tool
  - "Energy saving" function to operate the power source cooling fan and torch water cooling only when necessary
  - Excellent arc striking always precise and efficient
  - Ability to partially or totally lock the equipment with access key by password
  - Reduced energy consumption
  - Trouble shooting auto-diagnosis feature
  - Initial and final crater control
  - VRD – Voltage Reduction Device,
- Standart package:**  
Fe - CrNi - AlMg - AISi
- Optional package:**  
Fe - CrNi - AlMg - AISi - CuSi3 - AlBz8 - FCW (Rutil - Basic - Metal) Duplex - Super Duplex



Input Voltage	V	3 Phase, 50/60 Hz, 400 ± 20 V
Installed Power	kVA	23.7
Fuse (delayed action)	A	32
Open Circuit Voltage	V	63
Current Range	A	10-400
Duty Cycle at (40°C)	%100 %60 %40	300 / 350 / 400
Standards		<b>EN 60974-1 / EN 60974-5 / EN 60974-10</b>
Usable Wire Diameters		0.6 - 1.2
Protection Class	IP	23 S
Insulation Class		H
Dimensions ((L*W*H)	mm	660 / 290 / 515
Weight	kg	43

 Vision Pipe  
(Optional)

 Vision Ultraspeed  
(Optional)

 Vision Cold  
(Optional)

 Vision Power  
(Optional)

**STANDARD & OPTIONAL EQUIPMENTS**

This Order Code Covers The Welding Machine and All of The Equipments  
**3021000038**  
 Air Cooled  
**3021000039**  
 Water Cooled

**1021000022**

**1051900011**

**2020900649**

**1051300003**

**1024300001**  
(Optional)

**2020900176**  
(Optional)

**1051900012**  
(Optional)

GEDiK Welding provides full support for after sales services. 1 year warranty.

**Inverter**

- Spatter free exceptional welding characteristics in both MIG/MAG and PULSE & DOUBLE PULSE MIG on any material and with any gas
- Multifunction equipment with premium welding quality in MIG/MAG, MMA and TIG by "LIFT" mode
- Synergetic digital control of all the welding parameters
- ARC software for premium performances with faster welding speed, higher welding wire deposition and reduced thermal dilatations
- User friendly and easy-to-use selection and recalling of the parameters and welding programs
- Personalized parameters: ability to store personalized welding parameters (JOBS).
- Excellent arc striking always precise and efficient
- Total or partial equipment access locking key by password
- Low Power Consumption results in daily operational cost savings
- "ENERGY SAVING" function to operate the power source cooling fan and torch water cooling only when necessary
- Long interconnecting cable: possibility of using up to 50 mt length, parameters can be adjusted from the feeder
- Robot interface facility on request
- You can select of 12 different languages
- SOFTWARE for special MIG/MAG process (Optional)
- VISION PIPE for first root pass of pipes (Optional)
- VISION COLD to weld thin material with a colder short arc with lower with lower heat transfer (Optional)
- VISION POWER for a more concentrated arc and deeper penetration (Optional)
- VISION ULTRASPEED for a higher welding speed (Optional)



		<b>4000</b>	<b>5000</b>
Input Voltage	V	3 Phase, 50/60 Hz, 400 ± 20	V
Installed Power	kVA	25.5	32
Fuse (delayed action)	A	30	40
Open Circuit Voltage	V	70	70
Current Range	A	10-400	10-500
Duty Cycle at (40°C)	%100 %60 %50	330 / 370 / 400	380 / 460 / 500
Standards		<b>EN 60974-1 / EN 60974-5 / EN 60974-10 / S</b>	
Protection Class	IP	23 S	
Insulation Class		H	
Usable Wire Diameters	Ø mm	0.6 - 1.6	
Dimensions ((L*W*H)	mm	660 / 290 / 515	660 / 290 / 515
Weight	kg	40	44



Vision Pipe (Optional)



Vision Ultraspeed (Optional)



Vision Cold (Optional)



Vision Power (Optional)

**STANDARD & OPTIONAL EQUIPMENTS**

This Order Code Covers The Welding Machine and All of The Equipments	This Order Code Covers The Welding Machine and All of The Equipments									
3021000051 4000 A	3021000052 5000 A	1021000029 4000 A	1021000030 5000 A	2020900649	1051300003	1024300003	2020900877	2020900176	1024400001	1051900012

GEDIK Welding provides full support for after sales services. 1 year warranty.



Inverter

- MIG - MAG / MMA (Electric Arc Welding) / TIG-LIFT (Argon) multiprocess functions
- Non-spatter welding even using %25 CO<sub>2</sub> mixture gas and gas cost advantage
- Standard programs for such as Unalloyed - Alloyed Steel / Stainless / Aluminium / Copper-Brazing / Nickel / Titanium
- Unique adjustable 0.1-32 Hz double pulse frequency is standard for Al, SS and Steel Alloys
- Memory function for 100 parameters
- Easy to adjust parameters such as pre-gas/post-gas, up-slope/down-slope, initial current/final current, crater filling-arc spot time etc
- When the stick out is changeable and long, constant function eliminates the disadvantages
- Newly developed tunnel protection and due to the revolution control of the cooling fan according to its duty cycle or ambient air temperature, the design prevents dust from entering the area where electronic components are installed
- Data editing / copying / transferring, using USB via machine front panel
- Unique wire feeding advantages via three wire straighteners and four feed rollers
- Interface board is located in the machine as a standard, which provides an easy connection to PLC, Automation & Robotic Systems
- Ease of control of the machine current using a standard torch without the need for high-cost torches with special control
- Optionally, monitoring of welding data from android mobile phone, tablet or PC, graphical welder test, amount of wire consumption, working time, recording of WPS work and print out etc. Technological advantages



Input Voltage	V	3 Phase, 50/60 Hz, 400 + 15 V
Installed Power	kVA	11
Fuse (delayed action)	A	25
Open Circuit Voltage	V	80
Current Range	A	30-320
Current Tension Range	V	15-30
Duty Cycle at (40°C)	%100 %60	283 / 320
Standards		<b>EN 60974-1 / EN 60974-5 / EN 60974-10 / S</b>
Protection Class	IP	23
Insulation Class		H
Dimensions ((L*W*H)	mm	395 / 710 / 592
Weight	kg	62

### WIRE FEEDER UNIT

Wire Feeder Units		CM-7403A-D
WireTypes		Fe / FC Aluminum
Usable Wire Diameters	Ø mm	0.8 / 1.0 / 1.2 1.0 / 1.2 / 1.6
Wire Feeding Speed	mt/min	22 max.
Dimensions ((L*W*H)	mm	710 / 240 / 395
Weight	kg	17

### STANDARD & OPTIONAL EQUIPMENTS

This Order Code Covers The Welding Machine and All of the Equipments <b>3021000046</b> Air Cooled <b>3021000047</b> Water Cooled										
	1021000025	1024400000	6051300012	2020900649	1051300003	1045000000	2020900878	2020900174	6000000441 (Optional)	6064100002 (Optional)

GEDIK Welding provides full support for after sales services. 1 year warranty.



Inverter

- MIG - MAG / MMA (Electric Arc Welding) / TIG-LIFT (Argon) multiprocess functions.
- Non-spatter welding even using %25 CO<sub>2</sub> mixture gas and gas cost advantage
- Standard programs for such as Unalloyed - Alloyed steel / stainless / Aluminium / Copper-Brazing / Nickel / Titanium
- Unique adjustable 0.1-32 Hz double pulse frequency is standard for Al, SS and Steel Alloys
- Memory function for 100 parameters
- Easy to adjust parameters such as pre-gas/post-gas, up-slope/down-slope, initial current/final current, crater filling-arc spot time etc
- When the stick out is changeable and long, constant function eliminate the disadvantages
- Newly developed tunnel protection and due to the revolution control of the cooling fan according to its duty cycle or ambient air temperature, the design prevents dust from entering the area where electronic components are installed
- Data editing / copying / transferring, using USB via machine front panel
- Unique wire feeding advantages via three wire straighteners and four feed rollers
- Interface board is located in the machine as a standard, which provides an easy connection to PLC, Automation & Robotic Systems
- Ease of control of the machine current using a standard torch without the need for high-cost torches with special control
- Optionally, monitoring of welding Data from android mobile phone, tablet or PC, graphical welder test, amount of wire consumption, working time, recording of WP8 work and print out etc. Technological advantages



Input Voltage	V	3 Phase, 50/60 Hz, 400 ± 15 V
Installed Power	kVA	19.2
Fuse (delayed action)	A	32
Open Circuit Voltage	V	70
Current Range	A	30-400
Current Tension Range	V	12-34
Duty Cycle at (40°C)	%50	400
Standards		EN 60974-1 / EN 60974-5 / EN 60974-10 / S
Protection Class	IP	23
Insulation Class		H
Dimensions ((L*W*H)	mm	395 / 710 / 592
Weight	kg	62

### WIRE FEEDER UNIT

Wire Feeder Units		CM-7403A-D
WireTypes		Fe / FC Aluminum
Usable Wire Diameters	Ø mm	0.8 / 0.9 / 1.0 / 1.2 / 1.4 / 1.6 1.0 / 1.2 / 1.6
Wire Feeding Speed	mt/min	22 max.
Dimensions ((L*W*H)	mm	710 / 240 / 395
Weight	kg	17

### STANDARD & OPTIONAL EQUIPMENTS

This Order Code Covers The Welding Machine and All of The Equipments										
3021000048	1021000026	1024400000	1051900031	2020900649	1051300003	1045000000	2020900878	2020900174	6000000441 (Optional)	6064100002 (Optional)

GEDIK Welding provides full support for after sales services. 1 year warranty.

# GeKaMac<sup>®</sup> PoWer MIG GPS WB 400 AC / DC



- MIG - MAG / MMA (Electric Arc Welding) / TIG-LIFT (Argon) multiprocess functions
- Low heat input with AC MIG, gap fill capability and excellent result for hard-welded materials with high welding speed
- Standard programs for such as Unalloyed - Alloyed Steel / Stainless / Aluminium / Copper-Brazing / Nickel / Titanium
- Unique adjustable 0.1-32 Hz double pulse frequency is standard for Al, SS and Steel Alloys
- Memory function for 100 parameters
- Easy to adjust parameters such as pre-gas/post-gas, up-slope/down-slope, initial current/final current, crater filling-arc spot time etc
- When the stick out is changable and long, constant function eliminate the disadvantages
- Newly developed tunnel protection and due to the revolution control of the cooling fan according to its duty cycle or ambient air temperature, the design prevents dust fromentering the area where electronic components are installed
- Data editing / copying / transferring, using USB via machine front panel
- Unique wire feeding advantages via three wire straighteners and four feed rollers.
- Interface board is located in the machine as a standart, which provides an easy connection to PLC, Automation & Robotie Systems
- Ease of control of the machine current using a standard torch without the need for high-cost torches with special control
- Optionally, monitoring of welding data from android mobile phone, tablet or PC, graphical welder test, amount of wire consumption, working time, recording of WPS work and print out etc. Technological advantages

Inverter



Input Voltage	V	3 Phase, 50/60 Hz, 400 ± 15 V
Installed Power	kVA	21,4
Fuse (delayed action)	A	32
Open Circuit Voltage	V	92
Current Range	A	30-400
Current Tension Range	V	12-34
Duty Cycle at (40°C)	%100 %60 %40	350 / 360 / 400
Standards		<b>EN 60974-1 / EN 60974-5 / EN 60974-10 / S</b>
Protection Class	IP	23
Insulation Class		H
Dimensions ((L*W*H)	mm	395 / 710 / 762
Weight	kg	86

## WIRE FEEDER UNIT

Wire Feeder Units		CM-7403A-D
WireTypes		Fe/FC Aluminum
Usable Wire Diameters	Ø mm	0.8 / 0.9 / 1.0 / 1.2 1.0 / 1.2 / 1.6
Wire Feeding Speed	mt/min	22 max.
Dimensions ((L*W*H)	mm	710 / 240 / 395
Weight	kg	17

## STANDARD & OPTIONAL EQUIPMENTS

This Order Code Covers The Welding Machine and All of The Equipments 3021000042 1021000070 1024400000 1051900031 2020900649 1051300003 1045000000 2020900878 2020900174										
	6000000441 (Optional)	6064100002 (Optional)								

GEDIK Welding provides full support for after sales services. 1 year warranty.



- MIG - MAG / MMA (Electric Arc Welding) / TIG-Lift (Argon) multiprocess functions
- Non-spatter welding even using 25% CO<sub>2</sub> mixture gas and gas cost advantage
- Standard programs for such as Unalloyed - Alloyed Steel / Stainless / Aluminium / Copper-Brazing / Nickel / Titanium
- Unique adjustable 0.1-32 Hz double pulse frequency is standard for Al, SS and Steel Alloys
- Memory function for 100 parameters
- Easy to adjust parameters such as pre-gas/post-gas, up-slope/down-slope, initial current/final current, crater filling-arc spot time etc
- When the stick out is changable and long, constant function eliminate the disadvantages
- Newly developed tunnel protection and due to the revolution control of the cooling fan according to its duty cycle or ambient air temperature, the design prevents dust from entering the area where electronic components are installed
- Data editing / copying / transferring, using USB via machine front panel
- Unique wire feeding advantages via three wire straighteners and four feed rollers.
- Interface board is located in the machine as a standart, which provides an easy connection to PLC, Automation & Robotic Systems
- Ease of control of the machine current using a standard torch without the need for high-cost torches with special control
- Optionally, monitoring of welding data from android mobile phone, tablet or PC, graphical welder test, amount of wire consumption, working time, recording of WPS work and print out etc. Technological advantages

Inverter



Input Voltage	V	3 Phase, 50/60 Hz, 400 ± 15 V
Installed Power	kVA	25
Fuse (delayed action)	A	32
Open Circuit Voltage	V	80
Current Range	A	30-550
Current Tension Range	V	12-39
Duty Cycle at (40°C)	%60	500
Standards		<b>EN 60974-1 / EN 60974-5 / EN 60974-10 / S</b>
Protection Class	IP	23
Insulation Class		H
Dimensions ((L*W*H)	mm	395 / 710 / 762
Weight	kg	83

### WIRE FEEDER UNIT

Wire Feeder Units		CM-7403A-D
Wire Types		Fe/FC Aluminum
Usable Wire Diameters	Ø mm	0.8 / 0.9 / 1.0 / 1.2 / 1.4 / 1.6 1.0 / 1.2 / 1.6
Wire Feeding Speed	mt/min	22 max.
Dimensions ((L*W*H)	mm	710 / 240 / 395
Weight	kg	17

### STANDARD & OPTIONAL EQUIPMENTS

<p>This Order Code Covers The Welding Machine and All of The Equipments</p> 										
3021000050	1021000028	1024400000	1051900031	2020900683	1051300003	1045000000	2020900078	2020900174	6000000441 (Optional)	6064100002 (Optional)

GEDIK Welding provides full support for after sales services. 1 year warranty.



- Compact type MIG/MAG welding machine, with wire feeding unit placed inside the machine
- Voltage calibration with 10 stages between 30-240 A welding current range
- High efficiency with 2 stage choke coil.
- Ideal for welding metal sheets up to 4.0 mm
- Wire feeding speed adjustment with 1-22 mt/min range.
- 2-4 trigger selection



Input Voltage	V	3 Phase, 50/60 Hz, 380 V
Installed Power	kVA	8
Fuse (delayed action)	A	32
Open Circuit Voltage	V	12-32
Current Range	A	30-240
Duty Cycle at (40°C)	%100 %60 %35	140 / 180 / 240
Standards		<b>EN 60974-1 / EN 60974-10</b>
Protection Class	IP	23
Insulation Class		H
Dimensions ((L*W*H)	mm	800 / 420 / 670
Weight	kg	82

### STANDARD & OPTIONAL EQUIPMENTS

This Order Code Covers The Welding Machine and All of The Equipments



3000900002

3020900001

1051900010 (3mt)

6051900022  
(4mt)  
(Optional)

2020900697

1051300003  
Argon

Please Select One

1051300015  
CO<sub>2</sub>

1051300016

GEDIK Welding provides full support for after sales services. 1 year warranty.





- Compact type MIG/MAG welding machine, with wire feeding unit placed inside the machine
- Voltage calibration with 10 stages between 30-250 A welding current range
- High efficiency with 2 stage choke coil
- Ideal for welding sheet metals up to 4.0 mm
- Wire feeding speed adjustment within 1-23 mt/min range
- 2-4 trigger selection



Input Voltage	V	3 Phase, 50/60 Hz, 380 V
Installed Power	kVA	15.6
Fuse (delayed action)	A	32
Open Circuit Voltage	V	18-47
Current Range	A	30-350
Duty Cycle at (40°C)	%100 %60 %40	230 / 300 / 350
Standards		<b>EN 60974-1 / EN 60974-5 / EN 60974-10 / S</b>
Usable Wire Diameters	mm	0.8 / 1.0 / 1.2
Protection Class	IP	23
Insulation Class		H
Dimensions ((L*W*H)	mm	930 / 480 / 900
Weight	kg	125

#### STANDARD & OPTIONAL EQUIPMENTS

This Order Code Covers The Welding Machine and All of The Equipments



3000900005



3020900003



6051900028  
(4mt)  
(Optional)



6011100078



1051300003  
Argon



1051300015  
CO<sub>2</sub>

Please Select One



1051300016

GEDIK Welding provides full support for after sales services. 1 year warranty.



- Compact type MIG/MAG welding machine, with wire feeding unit placed inside the machine
- Voltage calibration with 10 stages between 30-240 A welding current range
- High efficiency with 2 stage choke coil.
- Ideal for welding metal sheets up to 4.0 mm
- Wire feeding speed adjustment with 1-22 mt/min range.
- 2-4 trigger selection



Input Voltage	V	3 Phase, 50/60 Hz, 380 V
Installed Power	kVA	8
Fuse (delayed action)	A	32
Open Circuit Voltage	V	12-32
Current Range	A	30-240
Duty Cycle at (40°C)	%100 %60 %35	140 / 180 / 240
Standards		<b>EN 60974-1 / EN 60974-10</b>
Protection Class	IP	23
Insulation Class		H
Dimensions ((L*W*H)	mm	800 / 420 / 670
Weight	kg	82

### STANDARD & OPTIONAL EQUIPMENTS

<p>This Order Code Covers The Welding Machine and All of The Equipments</p> 						
3000900002	3020900001	1051900010 (3mt)	6051900022 (4mt) (Optional)	2020900697	<p>Please Select One</p> <p>1051300003 Argon</p> <p>1051300015 CO<sub>2</sub></p>	1051300016

GEDIK Welding provides full support for after sales services. 1 year warranty.



- Gas cooled MIG/MAG welding machine, which provides easy access to the work area by separating wire feed unit
- Voltage calibration with 12 stages between 30-350 a welding current range
- Wire feeding unit with 4 rolls
- High efficiency with 2 stage choke coil
- Ideal for welding sheet metals up to 8.0 mm.
- Wire feeding speed adjustment within 1-22 mt/min range
- 2-4 trigger selection
- Digital current and voltage indicator



Input Voltage	V	3 Phase, 50/60 Hz, 380 V
Installed Power	kVA	16
Fuse (delayed action)	A	32
Open Circuit Voltage	V	13-45
Current Range	A	30-350
Duty Cycle at (40°C)	%100 %60 %40	210 / 270 / 350
Standards		<b>EN 60974-1 / EN 60974-5 / EN 60974-10 / S</b>
Protection Class	IP	23
Insulation Class		H
Dimensions ((L*W*H)	mm	1075 / 500 / 800
Weight	kg	125

#### WIRE FEEDER UNIT

Usable Wire Diameters	Ø mm	0.8 / 1.0 / 1.2
Wire Types		Fe / FC
Wire Feeding Speed	mt/min	22 max
Dimensions ((L*W*H)	mm	630 / 460 / 230
Weight	kg	15

#### STANDARD & OPTIONAL EQUIPMENTS

<p>This Order Code Covers The Welding Machine and All of The Equipments</p>  <p>3000900004</p>	 <p>3020900005</p>	 <p>1051900011 (3mt)</p>	 <p>6051900028 (4mt) (Optional)</p>	 <p>6011100078</p>	 <p>Please Select One</p> <p>1051300003 Argon</p> <p>1051300015 CO<sub>2</sub></p>	 <p>1051300016</p>	 <p>2020900244/5mt 2020900254/10mt (Optional) 2020900275/15mt (Optional)</p>
-----------------------------------------------------------------------------------------------------------------------------------------------------------------------------------	-------------------------------------------------------------------------------------------------------	-----------------------------------------------------------------------------------------------------------------	--------------------------------------------------------------------------------------------------------------------------------	-------------------------------------------------------------------------------------------------------	-----------------------------------------------------------------------------------------------------------------------------------------------------------------------	-------------------------------------------------------------------------------------------------------	---------------------------------------------------------------------------------------------------------------------------------------------------------------------------------

GEDiK Welding provides full support for after sales services. 1 year warranty.



- Compact type MIG/MAG welding machine, with the wire feeding unit placed inside the machine
- Voltage calibration with 18 stages between 30-420 a welding current range
- High efficiency with 2 stage choke coil
- Ideal for welding metal sheets up to 15 mm
- Wire feeding speed adjustment within 1-22 mt/min range.
- 2-4 trigger selection
- Digital current and voltage indicator



Input Voltage	V	3 Phase, 50/60 Hz, 380 V
Installed Power	kVA	17.5
Fuse (delayed action)	A	42
Open Circuit Voltage	V	13-43
Current Range	A	30-420
Duty Cycle at (40°C)	%100 %60 %45	280 / 360 / 420
Standards	<b>EN 60974-1 / EN 60974-5 / EN 60974-10 / S</b>	
Usable Wire Diameters	Ø mm	0.8 / 1.0 / 1.2
Protection Class	IP	23
Insulation Class	H	
Dimensions ((L*W*H)	mm	1075 / 500 / 800
Weight	kg	140

#### STANDARD & OPTIONAL EQUIPMENTS

This Order Code Covers The Welding Machine and All of The Equipments 					Please Select One 		
3000900008	3020900020	1051900011 (3mt)	6051900028 (4mt) (Optional)	6011100078	1051300003 Argon	1051300015 CO <sub>2</sub>	1051300016

GEDIK Welding provides full support for after sales services. 1 year warranty.



- Compact type, water cooled MIG/MAG welding machine, with wire feeding unit placed inside the machine
- Voltage calibration with 18 stages between 30-420 a welding current range
- High efficiency with 2 stage choke coil
- Ideal for welding metal sheets up to 15 mm
- It is preferred by heavy industrial companies
- Wire feeding speed adjustment within 1-22 mt/min range
- 2-4 trigger selections
- Digital current and voltage indicators



Input Voltage	V	3 Phase, 50/60 Hz, 380 V
Installed Power	kVA	17.6
Fuse (delayed action)	A	42
Open Circuit Voltage	V	13-43
Current Range	A	30-420
Duty Cycle at (40°C)	%100 %60 %45	280 / 360 / 420
Standards		<b>EN 60974-1 / EN 60974-5 / EN 60974-10 / S</b>
Usable Wire Diameters	Ø mm	0.8 - 1.0 - 1.2
Protection Class	IP	23
Insulation Class		H
Dimensions ((L*W*H)	mm	1075 / 500 / 800
Weight	kg	165

### STANDARD & OPTIONAL EQUIPMENTS

<p>This Order Code Covers The Welding Machine and All of The Equipments</p>					  <p>Please Select One</p>	
3000900009	3020900019	1051900012 (3mt)	6051900040 (4mt) (Optional)	6011100078	1051300003 Argon 1051300015 CO <sub>2</sub>	1051300016

GEDiK Welding provides full support for after sales services. 1 year warranty.



- Gas cooled MIG/MAG welding machine, which provides easy access to the work area by separating wire feeding unit
- Voltage calibration with 18 stages between 30-420 a welding current range
- Wire feeding system with 4 rolls
- High efficiency with 2 stage choke coil
- Ideal for welding metals sheets up to 15 mm
- Wire feeding speed adjustment within 1-22 mt/min range
- 2-4 trigger selections
- Digital current and voltage indicators



Input Voltage	V	3 Phase, 50/60 Hz, 380 V
Installed Power	kVA	17.5
Fuse (delayed action)	A	42
Open Circuit Voltage	V	13-43
Current Range	A	30-420
Duty Cycle at (40°C)	%100 %60 %45	280 / 360 / 420
Standards		<b>EN 60974-1 / EN 60974-5 / EN 60974-10 / S</b>
Protection Class	IP	23
Insulation Class		H
Dimensions ((L*W*H)	mm	1075 / 500 / 800
Weight	kg	140

### WIRE FEEDER UNIT

Usable Wire Diameters	Ø mm	0.8 / 1.0 / 1.2
Wire Types		Fe/FC
Wire Feeding Speed	mt/min	22 max
Dimensions ((L*W*H)	mm	630 / 460 / 230
Weight	kg	15

### STANDARD & OPTIONAL EQUIPMENTS

<p>This Order Code Covers The Welding Machine and All of The Equipments</p> <p>3000900006</p>	 <p>3020900021</p>	 <p>1051900011 (3mt)</p>	 <p>6051900028 (4mt) (Optional)</p>	 <p>6011100078</p>	 <p>Please Select One</p> <p>1051300003 Argon</p> <p>1051300015 CO<sub>2</sub></p>	 <p>1051300016</p>	 <p>2020900244/5mt 2020900254/10mt (Optional) 2020900275/15mt (Optional)</p>
-----------------------------------------------------------------------------------------------	-------------------------------------------------------------------------------------------------------	-----------------------------------------------------------------------------------------------------------------	--------------------------------------------------------------------------------------------------------------------------------	-------------------------------------------------------------------------------------------------------	-----------------------------------------------------------------------------------------------------------------------------------------------------------------------	-------------------------------------------------------------------------------------------------------	---------------------------------------------------------------------------------------------------------------------------------------------------------------------------------

GEDIK Welding provides full support for after sales services. 1 year warranty.



- Water cooled MIG/MAG welding machine, which provides easy access to the work area by separating the wire feeding unit
- Voltage calibration with 18 stages between 30-420 A welding current range
- Wire feeding system with 4 rolls
- High efficiency with 2 stage choke coil
- Ideal for welding metal sheets up to 15 mm
- It is preferred by heavy industrial companies
- Wire feeding speed adjustment within 1-22 mt/min range
- 2-4 trigger selection
- Digital current and voltage indicator



Input Voltage	V	3 Phase, 50/60 Hz, 380 V
Installed Power	kVA	17.6
Fuse (delayed action)	A	42
Open Circuit Voltage	V	13-43
Current Range	A	30-420
Duty Cycle at (40°C)	%100 %60 %45	280 / 360 / 420
Standards		<b>EN 60974-1 / EN 60974-5 / EN 60974-10 / S</b>
Protection Class	IP	23
Insulation Class		H
Dimensions ((L*W*H)	mm	1075 / 500 / 800
Weight	kg	162

### WIRE FEEDER UNIT

Usable Wire Diameters	Ø mm	0.8 / 1.0 / 1.2
Wire Types		Fe / FC
Wire Feeding Speed	mt/min	22 max
Dimensions ((L*W*H)	mm	630 / 460 / 230
Weight	kg	15

### STANDARD & OPTIONAL EQUIPMENTS

This Order Code Covers The Welding Machine and All of The Equipments							
3020900007	3020900035	1051900012 (3mt)	6051900040 (4mt) (Optional)	6011100078	1051300003 Argon 1051300015 CO <sub>2</sub>	1051300016	2020900244/5mt (Optional) 2020900254/10mt (Optional) 2020900275/15mt (Optional)

GEDiK Welding provides full support for after sales services. 1 year warranty.



- Air cooled MIGI/MAG welding machine, which gives easy access to the work area by separating the wire teeding unit
- Voltage calibration with 36 (4x9) stages between 40-500 A welding current range
- Wire teeding system with 4 rolls
- High efficiency with 4 stage choke coil
- Ideal for welding metal sheets up to 40 mm
- It is preferred by heavy industrial companies
- Wire teeding speed adjustment within 1-22 mt/min range
- 2-4 trigger selection
- Digital current and voltage indicator



Input Voltage	V	3 Phase, 50/60 Hz, 380 V
Installed Power	kVA	27.5
Fuse (delayed action)	A	63
Open Circuit Voltage	V	16-57
Current Range	A	40-500
Duty Cycle at (40°C)	%100 %60 %45	400 / 500
Standards		<b>EN 60974-1 / EN 60974-5 / EN 60974-10 / S</b>
Protection Class	IP	23
Insulation Class		H
Dimensions ((L*W*H)	mm	1100 / 510 / 1440
Weight	kg	211

### WIRE FEEDER UNIT

Usable Wire Diameters	Ø mm	0.8 / 1.0 / 1.2 / 1.6
Wire Types		Fe / FC
Wire Feeding Speed	mt/min	22 max
Dimensions ((L*W*H)	mm	630 / 460 / 230
Weight	kg	15

### STANDARD & OPTIONAL EQUIPMENTS

This Order Code Covers The Welding Machine and All of The Equipments 							
3000900010	3020900123	1051900011 (3mt)	6051900028 (4mt) (Optional)	2020900660	Please Select One 1051300003 Argon    1051300015 CO <sub>2</sub>	1051300016	2020900244/5mt 2020900254/10mt (Optional) 2020900275/15mt (Optional)

GEDIK Welding provides full support for after sales services. 1 year warranty.





- Water cooled MIG/MAG welding machine, which gives easy access to the work area by separating the wire feeding unit
- Voltage calibration with 36 (4x9) stages between 40-500 A welding current range
- Wire feeding system with 4 rolls
- High efficiency with 4 stage choke coil
- Ideal for welding metal sheets up to 40 mm
- It is preferred by heavy industrial companies
- Wire feeding speed adjustment within 1-22 mt/min range
- 2-4 trigger selection
- Digital current and voltage indicator



Input Voltage	V	3 Phase, 50/60 Hz, 380 V
Installed Power	kVA	27.5
Fuse (delayed action)	A	63
Open Circuit Voltage	V	16-57
Current Range	A	40-500
Duty Cycle at (40°C)	%100 %60	400 / 500
Standards		<b>EN 60974-1 / EN 60974-5 / EN 60974-10 / S</b>
Protection Class	IP	23
Insulation Class		H
Dimensions ((L*W*H)	mm	1100 / 510 / 1440
Weight	kg	211

#### WIRE FEEDER UNIT

Usable Wire Diameters	Ø mm	0.8 / 1.0 / 1.2 / 1.6
Wire Types		Fe / FC
Wire Feeding Speed	mt/min	22 max
Dimensions ((L*W*H)	mm	630 / 460 / 230
Weight	kg	15

#### STANDARD & OPTIONAL EQUIPMENTS

<p>This Order Code Covers The Welding Machine and All of The Equipments</p> 								
3000900011	3020900063	1051900012 (3mt)	6051900040 (4mt) (Optional)	2020900660	1051300003 Argon	1051300015 CO <sub>2</sub>	1051300016	2020900244/5mt 2020900254/10mt (Optional) 2020900275/15mt (Optional)

GEDİK Welding provides full support for after sales services. 1 year warranty.



- Water cooled MIG/MAG welding machine, which gives easy access to the work area by separating the wire teeding unit
- Voltage calibration with 36 (4x9) stages between 40-600 A welding current range
- Wire teeding system with 4 rolls
- High efficiency with 4 stage choke coil
- Ideal for welding metal sheets up to 50 mm
- It is preferred by heavy industrial companies
- Wire teeding speed adjustment within 1-22 mt/min range
- 2-4 trigger selection
- Digital current and voltage indicator



Input Voltage	V	3 Phase, 50/60 Hz, 380 V
Installed Power	kVA	33.6
Fuse (delayed action)	A	63
Open Circuit Voltage	V	18-60
Current Range	A	40-600
Duty Cycle at (40°C)	%100 %60 %45	410 / 520 / 600
Standards		<b>EN 60974-1 / EN 60974-5 / EN 60974-10 / S</b>
Protection Class	IP	23
Insulation Class		H
Dimensions ((L*W*H)	mm	1100 / 510 / 1440
Weight	kg	265

### WIRE FEEDER UNIT

Usable Wire Diameters	Ø mm	0.8 / 1.0 / 1.2 / 1.6
Wire Types		Fe / FC
Wire Feeding Speed	mt/min	22 max
Dimensions ((L*W*H)	mm	630 / 460 / 230
Weight	kg	15

### STANDARD & OPTIONAL EQUIPMENTS

<p>This Order Code Covers The Welding Machine and All of The Equipments</p> <p>3000900013</p>	 <p>3020900077</p>	 <p>1051900012 (3mt)</p>	 <p>6051900040 (4mt) (Optional)</p>	 <p>2020900660</p>	 <p>Please Select One 1051300003 Argon</p>	 <p>1051300015 CO<sub>2</sub></p>	 <p>1051300016</p>	 <p>2020900258/5 mt 2020900259/10 mt (Optional) 2000200661/15mt (Optional)</p>
-----------------------------------------------------------------------------------------------	-------------------------------------------------------------------------------------------------------	-----------------------------------------------------------------------------------------------------------------	--------------------------------------------------------------------------------------------------------------------------------	-------------------------------------------------------------------------------------------------------	---------------------------------------------------------------------------------------------------------------------------------------	--------------------------------------------------------------------------------------------------------------------------	-------------------------------------------------------------------------------------------------------	-----------------------------------------------------------------------------------------------------------------------------------------------------------------------------------

GEDIK Welding provides full support for after sales services. 1 year warranty.



- Arc parameter electronic control for an excellent cutting quality
- Cutting parameters stability within  $\pm 10\%$  mains voltage fluctuations long lasting consumable parts
- Innovative and user friendly design
- Robust handle integrated into the chassis
- Control rack protection cover
- IP 23 protection class and dust-proof electronic components, thanks to the innovative "Tunnel" fan cooling system, allow their use in the toughest work environment
- Electrode wearing and improper operation signalling
- Possibility of cutting grids and perforated lamination sheets
- Contact cutting possibility without sliding blocks or other spacers
- Central connector for the torch
- Built-in filter with air impurity automatic expulsion
- PFC - Power Factor Correction (Cos  $f=1$ )
- The PFC circuit gives the machine a wider protection against mains voltage fluctuations, by also making it safer whenever being operated by power generator sets



Input Voltage	V	1 Phase 50/60 Hz, 230 V, $\pm 10$
Installed Power	kVA	5.5
Fuse (delayed action)	A	16
Current Range	A	20-40
Cutting Capacity	mm	Severence: 15 / Quality: 10
Duty Cycle at (40°C)	%100 %60 %40	20 / 30 / 40
Standards		<b>EN 60974-1 / IEC 60974-7 / EN 60974-10 / S</b>
Protection Class	IP	23 S
Insulation Class		H
Dimensions ((L*W*H)	mm	490 / 185 / 390
Weight	kg	16

#### STANDARD & OPTIONAL EQUIPMENTS

This Order Code Covers The Welding Machine and All of The Equipments



3021000126

3021000086

1051900023

2020900841

GEDiK Welding provides full support for after sales services. 1 year warranty.



Inverter

- Arc parameter electronic control for an excellent cutting quality
- Energy saving function to switch off the power source cooling fan when no longer necessary
- Cutting parameters stability within  $\pm 10\%$  mains voltage fluctuations
- Long lasting consumable parts
- Innovative and user friendly design
- IP 23 protection class and dust-proof electronic components, thanks to the innovative. "Tunnel" fan cooling system, allow their use in the toughest work environment
- Electrode wearing and improper operation signalling
- Possibility of cutting grids and perforated lamination sheets
- Contact cutting possibility without sliding blocks or other spacers



Input Voltage	V	3 Phase 50/60 Hz, 400 V, $\pm 10$
Installed Power	kVA	7.5
Fuse (delayed action)	A	10
Current Range	A	20-60
Cutting Capacity	mm	Severence: 20 / Quality: 15
Duty Cycle at (40°C)	%100 %60 %35	40 / 50 / 60
Standards	IP	<b>EN 60974-1 / IEC 60974-3 / EN 60974-7 / EN 60974-10 / S</b>
Protection Class		23 S
Insulation Class	mm	H
Dimensions ((L*W*H)	kg	390 / 185 / 595
Weight		23

## STANDARD & OPTIONAL EQUIPMENTS

This Order Code Covers The Welding Machine and All of The Equipments



3021000056

1021000034

1051900025

2020900841

GEDIK Welding provides full support for after sales services. 1 year warranty.



Inverter

- Arc parameter electronic control for an excellent cutting quality
- Energy saving function to switch off the power source cooling fan when no longer necessary
- Cutting parameters stability within  $\pm$  %10 mains voltage fluctuations.
- Innovative and user friendly design
- IP 23 protection class and dust-proof electronic components, thanks to the innovative. "Tunnel" fan cooling system, allow their use in the toughest work environment
- Electrode wearing and improper operation signalling
- Possibility of cutting grids and perforated lamination sheets
- Contact cutting possibility without sliding blocks or other spacers
- Central connector for the torch
- Regulator group with built-in filter and air impurity automatic expulsion



Input Voltage	V	3 Phase 50/60 Hz, 400 V, $\pm$ 10
Installed Power	kVA	15
Fuse (delayed action)	A	16
Current Range	A	20-100
Cutting Capacity	mm	Severance: 35 / Quality: 25
Duty Cycle at (40°C)	%100 %60 %40	70 / 85 / 100
Standards		<b>EN 60974-1 / IEC 60974-3 / EN 60974-7 / EN 60974-10 / S</b>
Protection Class	IP	23 S
Insulation Class		H
Dimensions ((L*W*H)	mm	610 / 220 / 425
Weight	kg	32

## STANDARD & OPTIONAL EQUIPMENTS

This Order Code Covers The Welding Machine and All of The Equipments



3021000057

1021000035

1052000009

2020900649

GEDiK Welding provides full support for after sales services. 1 year warranty.

**Inverter**

- Arc parameter electronic control for an excellent cutting quality
- Energy saving function to switch off the power source cooling fan when no longer necessary
- Cutting parameters stability within  $\pm 10\%$  mains voltage fluctuations
- Innovative and user friendly design
- IP 23 protection class and dust-proof electronic components, thanks to the innovative
- "Tunnel" fan cooling system, allow their use in the toughest work environment
- Electrode wearing and improper operation signalling
- Possibility of cutting grids and perforated lamination sheets
- Contact cutting possibility without sliding blocks or other spacers
- Central connector for the torch
- Regulator group with built-in filter and air impurity automatic expulsion



Input Voltage	V	3 Phase 50/60 Hz, 400 V, $\pm 10$
Installed Power	kVA	27.5
Fuse (delayed action)	A	30
Current Range	A	25-150
Cutting Capacity	mm	Severence: 50 / Quality: 40
Duty Cycle at (40°C)	100% 60% 30%	100 / 120 / 150
Standards		<b>EN 60974-1/IEC 60974-3/EN 60974-7/EN 60974-10/S</b>
Protection Class	IP	23 S
Insulation Class		H
Dimensions ((L*W*H)	mm	730 / 290 / 515
Weight	kg	49

**STANDARD & OPTIONAL EQUIPMENTS**

This Order Code Covers The Welding Machine and All of The Equipments

**3021000106**
**1021000036**
**1051900028**
**2020900649**

GEDIK Welding provides full support for after sales services. 1 year warranty.



Inverter

- Especially designed for use under heavy working conditions
- Very good welding performance with time adjustment control
- Suitable for long working conditions with %100 duty cycle
- Digital current and voltage setting display
- Suitable to work under  $\pm$  %10 voltage fluctuations and constant welding current at high temperature
- Suitable for very long welding seams and very thick workpieces.
- Embedded expert program with 10 sets of complete welding parameters
- Uninfluenced by input voltage fluctuation
- Digital communication between tractor and welder
- 3 and 4 wheeled tractor unit (optional)
- Flux collecting unit
- The slides have the ability to move horizontally and vertically
- Smart fan feature greatly expands working life
- Self-diagnostic function with error code display
- Electro slag welding facility

**Mode:**

- Lift-TIG, MMA Welding, MIG Welding Mode (CV)

**Extra Functions:**

- Hot Start
- Arc Force
- Wire diameter selection
- CC / CV selection
- Inductance setting



Input Voltage	V	3 Phase 50/60 Hz, 380 V, $\pm$ 20
Installed Power	kVA	54.6
Fuse (delayed action)	A	83
Open Circuit Voltage	V	84
Current Range	A	60-100
Duty Cycle at (40°C)	%100	1000
Standards	<b>EN ISO 60974-1 / EN ISO 60974-10</b>	
Protection Class	IP	23
Insulation Class	H	
Dimensions ((L*W*H)	mm	767 / 352 / 757
Weight	kg	95

**STANDARD & OPTIONAL EQUIPMENTS**

This Order Code Covers The Welding Machine and All of The Equipments								
3021000099	1021000063	1020900004	1020900005 (Optional)	2020900686	6051900107 (Optional)	2020900879	105180000 15 mt	1000900188 10 mt

GEDiK Welding provides full support for after sales services. 1 year warranty.



Inverter

- Especially designed for use under heavy working conditions
- Very good welding performance with tine adjustment control
- Suitable for long working conditions with %100 duty cycle
- Digital current and voltage setting display
- Suitable to work under  $\pm$  %10 voltage fluctuations and constant welding current at high temperature
- Suitable for very long welding seams and very thick workpieces.
- Embedded expert program with 10 sets of complete welding parameters
- Uninfluenced by input voltage fluctuation
- Digital communication between tractor and welder
- 3 and 4 wheeled tractor unit (optional)
- Flux collecting unit
- The slides have the ability to move horizontally and vertically
- Smart fan feature greatly expands working life
- Self-diagnostic function with error code display
- Electro slag welding facility

**Mode:**

- LIFT-TIG, MMA Welding, MIG Welding Mode (CV)

**Extra Functions:**

- Hot Start
- Arc Force
- Wire diameter selection
- CC / CV selection
- Inductance setting



Input Voltage	V	3 Phase, 50/60 Hz, 380 $\pm$ 15 V
Installed Power	kVA	75
Fuse (delayed action)	A	115
Open Circuit Voltage	V	92
Current Range	A	60-1250
Duty Cycle at (40°C)	100%	1250
Standards	<b>EN 60974-1 / EN 60974-5 / EN 60974-10</b>	
Protection Class	IP	23 S
Insulation Class	H	
Dimensions ((L*W*H)	mm	788 / 366 / 815
Weight	kg	105

**STANDARD & OPTIONAL EQUIPMENTS**

This Order Code Covers The Welding Machine and All of The Equipments								
	3021000100	1021000064	1020900004	1020900005 (Optional)	2020900686	6051900107 (Optional)	2020900879	105180000 15 mt

GEDIK Welding provides full support for after sales services. 1 year warranty.





# WELDING ACCESSORIES

**GeKa MMA Welding Accessories**

Product	Product Code
200 A Electrode Holder	1000900547
500 A Electrode Holder	1000900059



Product	Product Code
400 A Earth Clamp	1000900060



Product	Product Code
10-25 mm <sup>2</sup> Female Jack Set	1000900548
50-70 mm <sup>2</sup> Female Jack Set	1000900516
70-95 mm <sup>2</sup> Female Jack Set	1000900338



Product	Product Code
10-25 mm <sup>2</sup> Male Jack Set	1000900549
50-70 mm <sup>2</sup> Male Jack Set	1000900520
50-70 mm <sup>2</sup> Male Jack Set	1000900336
70-95 mm <sup>2</sup> Male Jack Set	1000900337



Product	Product Code
GGS WP 26 V Valve Control TIG 4 m Torch	6051900088

## TIG Torch



Product	Product Code	Lenght	Cooling Type
GeKa WP17	6051900071	4 m	Air
GeKa WP17	6051900073	8 m	Air
GeKa WP 26	6051900083	4 m	Air
GeKa WP 26	6051900084	8 m	Air
GeKa WP18	6051900076	4 m	Water
GeKa WP18	6051900077	8 m	Water

## Body

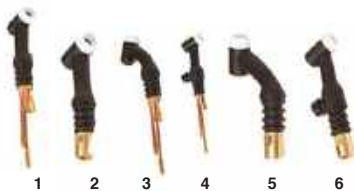

No.	Product	Product Code
1	WP 18 TIG Torch Body (Water Cooled)	6052000565
2	WP 26 TIG Torch Body (Air)	6052000570
3	WP 18F Flexible TIG Torch Body (Water Cooled)	6052000566
4	WP 18V Valve TIG Torch Body (Water Cooled)	6052000567
5	WP 26F Flexible TIG Torch Body (Air)	6052000571
6	WP 26V Valve TIG Torch Body (Air)	6052000572

## Electrode Back Cap



No.	Product	Product Code
1	GeKa Electrode Long Back Cap 57Y02	6052000184
2	GeKa Electrode Med. Back Cap 57Y03	6052000575
3	GeKa Electrode Short Back Cap 57Y04	6052000183

## Ceramic Nozzles



Product	Product Code
GeKa Ceramic Nozzle No:4 10N50	6052000255
GeKa Ceramic Nozzle No:5 10N49	1052000006
GeKa Ceramic Nozzle No:6 10N48	1052000007
GeKa Ceramic Nozzle No:7 10N47	6052000258
GeKa Ceramic Nozzle No:8 10N46	6052000259

## Collet and Collet Bodies

Product	Product Code	Product	Product Code
Collet (17/18/26) 1.6mm 10N23	6052000169	Collet Body (17/18/26) 1.6mm 10N31	6052000176
Collet (17/18/26) 2.0mm 10N23M	6052000171	Collet Body (17/18/26) 2.0mm 10N24M	6052000178
Collet (17/18/26) 2.4mm 10N24	1052000002	Collet Body (17/18/26) 2.4mm 10N32	1052000004
Collet (17/18/26) 3.2mm 10N25	6052000174	Collet Body (17/18/26) 3.2mm 10N28	6052000181

## Foot Remote Control



Product	Product Code
PSR 7 Foot Pedal	6051300053

## Analog Remote Control



Product	Product Code
DC6 Remote Control 5 m	6051300012

## Gas Pressure Regulator



Product	Product Code
Argon Gas Pressure Regulator	1051300003
CO2 Gas Pressure Regulator	1051300015

## Heater



Product	Ürün Kodu
GeKa CO2 Heater	1051300016

## MIG-MAG Welding Torch

**GSS 400 A**
**GSS 350 A**
**GGS 250 A**

**GGS 500 A**
**GGS 360 A**
**GGS 250 A**
**GGS 150 A**

Product	Product Code	Lenght	Cooling Type
GSS 400 A	1051900031	3 mt	Water
GSS 350 A	6051900132	3 mt	Water
GSS 250 A	6051900163	3 mt	Air
GSS 500 A	1051900012	3 mt	Water
GSS 500 A	6051900040	4 mt	Water
GGS 360 A	1051900011	3 mt	Air
GGS 360 A	6051900028	4 mt	Air
GGS 250 A	1051900010	3 mt	Air
GGS 250 A	6051900022	4 mt	Air
GGS 150 A	1051900009	3 mt	Air
GGS 150 A	6051900019	4 mt	Air

**1**
**2**
**3**
**4**

No.	Product	Product Code
1	GeKa 15 Torch Neck	6052000212
2	GeKa 25 Torch Neck	6052000227
3	GeKa 36 Torch Neck	6052000231
4	GeKa 501 Torch Neck	6052000235

## Nozzles

**1-2**
**3**
**4**
**5**
**6**
**7**

No.	Product	Product Code
1	GSS 400 Conic Nozzle	6052000368
2	GSS 350 Conic Nozzle	6052000368
3	GGS 280 Conic Nozzle	6052000367
4	GSS 501 Conic Nozzle	6052000113
5	GGS 36 Conic Nozzle	6052000104
6	GGS 25 Conic Nozzle	6052000222
7	GGS 15 Conic Nozzle	6052000210

## Contact Tip



No.	Product	Product Code
1	M6 0.8 mm Contact Tip	6052000532
1	M6 1.0 mm Contact Tip	6052000533
1	M6 1.2 mm Contact Tip	6052000534
2	M6 0.8 mm Contact Tip E-Cu L=25	6052000140
3	M6 0.8 mm Contact Tip E-Cu	6052000150
3	M6 1.0 mm Contact Tip E-Cu	6052000151
3	M6 1.2 mm Contact Tip E-Cu	6052000152
3	M6 0.8 mm Contact Tip (CuCrZr)	6052000155
3	M6 1.0 mm Contact Tip (CuCrZr)	6052000156
3	M6 1.2 mm Contact Tip (CuCrZr)	6052000157
3	M6 1.0 mm Contact Tip (ALU)	6052000153
3	M6 1.2 mm Contact Tip (ALU)	6052000154
4	M8 0.8 mm Contact Tip E-Cu	6052000158
4	M8 1.0 mm Contact Tip E-Cu	6052000159
4	M8 1.2 mm Contact Tip E-Cu	6052000160
4	M8 0.8 mm Contact Tip (CuCrZr)	6052000165
4	M8 1.0 mm Contact Tip (CuCrZr)	6052000166
4	M8 1.2 mm Contact Tip (CuCrZr)	6052000167
4	M8 1.0 mm Contact Tip (ALU)	6052000163
4	M8 1.2 mm Contact Tip (ALU)	6052000164
4	M8 1.6 mm Contact Tip E-Cu	6052000162

## Tip Holder and Diffusor



No.	Product	Product Code
1	GG5 280 A - GSS 400 A Tip Holder	1000901069
2	25 AK M6 Tip Holder	6052000219
3	36 AK M6 Tip Holder	6052000229
3	36 AK M8 Tip Holder	6052000230
4	501 D M8 Tip Holder	6052000233
5	GG5 280 A Diffusor	6052000062
6	GSS 350 A - 400 A Diffusor	6052000063
7	36 AK Diffusor - White	6052000228
7	36 AK Diffusor - Ceramic	6052000252
8	501 D Diffusor - White	6052000232
8	501 D Diffusor - Ceramic	6052000253

## Torch Liners / Spiral



Product	Length	Product Code
Steel 0.6 - 0.8 mm Blue Spiral	3.0 mt	6052000204
Steel 0.6 - 0.8 mm Blue Spiral	4.0 mt	6052000205
Steel 1.0 - 1.2 mm Red Spiral	3.0 mt	6052000293
Steel 1.0 - 1.2 mm Red Spiral	4.0 mt	6052000294
Teflon Spiral 1.0 - 1.2 mm Red	3.0 mt	6052000296
Steel Spiral 1.0 - 1.2 mm	3.0 mt	6052000200
Steel Spiral 1.0 - 1.2 mm	4.0 mt	6052000201
GG5 280 Steel Spiral	3.5 mt	6052000326
GSS 400 Steel Spiral	3.5 mt	6052000327
GSS 400 Steel Spiral	4.5 mt	6050000002
GSS 400 Teflon Spira	3.5 mt	6052000328

## Plasma Cutting Torch



No.	Product	Product Code	Length	Cooling Type
1	Plasma Cutting Torch CB150	1051900024	6 mt	Air
2	Plasma Cutting Torch CB70	1051900025	6 mt	Air
3	Plasma Cutting Torch PT6071	1051900023	4 mt	Air
1	CB150 Plasma Torch Neck	6052000433	-----	-----
2	CB70 Plasma Torch Neck	6052000448	-----	-----
3	PT60 Plasma Torch Neck	6052000453	-----	-----

## Plasma Nozzle



No.	Product	Product Code
1	CB150 Nozzle	6052000417
2	CB70 Nozzle	6052000445
3	PT60 Nozzle	6052000452
4	CB70 Distance Spring	6052000444
4	CB150 Distance Spring	6052000427
5	CB150 Double Distance Spring	6052000425

## Plasma Torch Tip



Product	Product Code
CB70 AirTube	6052000438
CB70 Tip 1,0 mm (Short)	6052000441
CB70 Tip 1,2 mm (Short)	6052000442
CB70 Tip 1,2 mm ((Long)	6052000443
CB70 Electrode (Short)	6052000439
CB70 Electrode ((Long)	6052000440
PT60 Tip 0,9 mm	6052000449
PT60 Electrode	6052000450

No.	Product	Product Code
1	CB150 Air Tube	6052000426
2	CB150 Tip 1,35 mm	6052000429
3	CB150 Tip 1,60 mm	6052000432
3	CB150 Tip 1,80 mm	6052000424
3	CB150 Electrode	6052000423

## Gas Diffusor



Product	Product Code
PT60 Gas Diffusor	6052000451
CB150 Gas Diffusor	6052000430
CB70 Front Insulator	6052000437
CB150 Front Insulator	6052000419

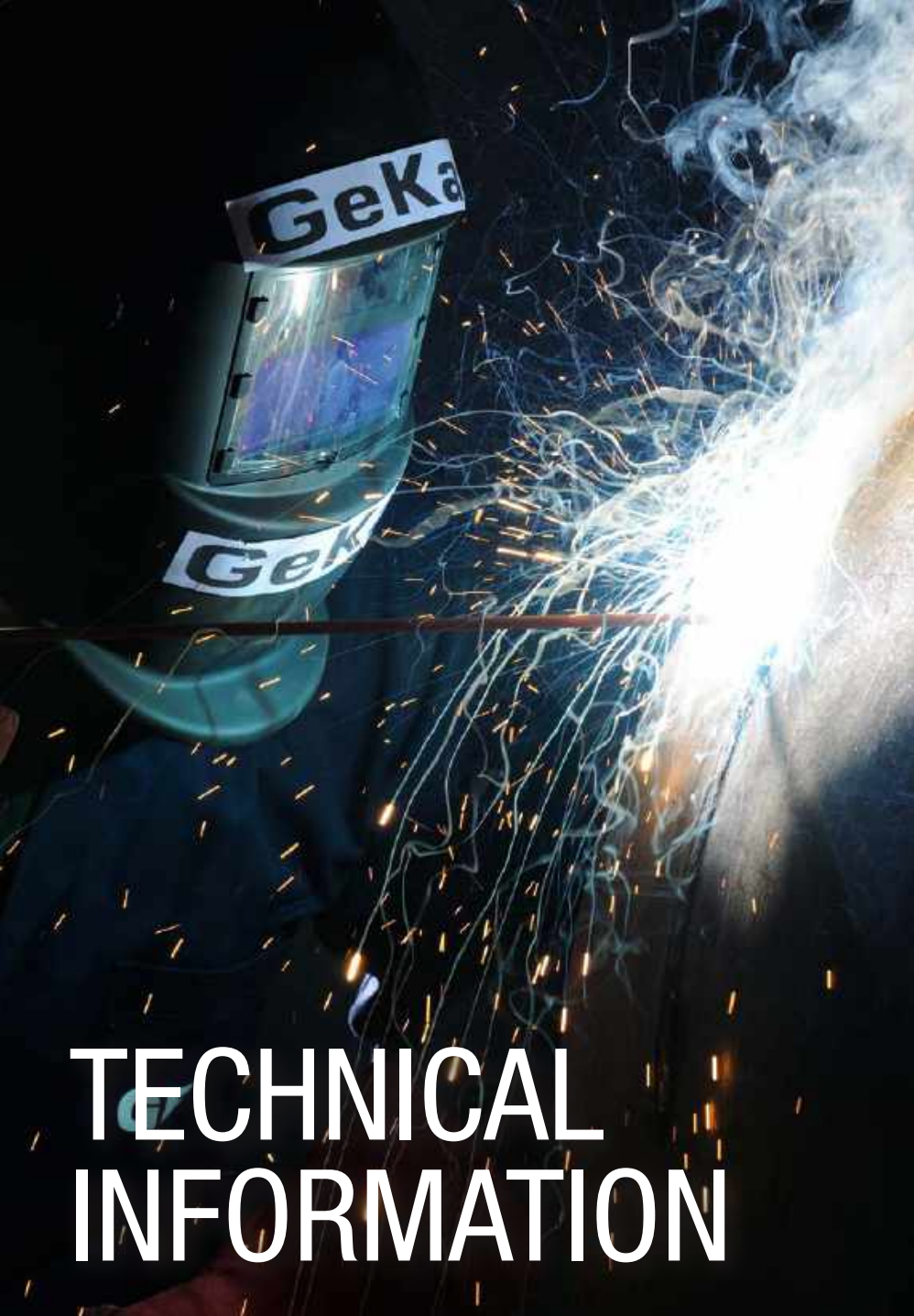

# TECHNICAL INFORMATION



## Table of the Electrodes for Manual Arc Welding of Non-alloy and Fine Grain Steels according to TS EN ISO 2560 -A

**E 46 3 1Ni B 6 4 H5**

Production / Product	
G	Wire Electrodes
O	Oxy-acetylene
E	Electric arc welding
S	Submerged arc welding wires
T	Flux-cored wires
W	TIG Rods
F	Submerged arc welding fluxes

Alloy Symbol	Chemical Composition % (1) 2) 3)		
	Mn	Mo	Ni
	2,00	-	-
Mo	1,40	0,3 - 0,6	-
MnMo	> 1,4 - 2,0	0,3 - 0,6	-
1 Ni	-	-	0,6 - 1,2
2 Ni	1,40	-	1,8 - 2,6
3 Ni	1,40	-	> 2,6 - 3,8
Mn 1Ni	> 1,4 - 2,0	-	0,6 - 1,2
1 NiMo	1,40	0,3 - 0,6	0,6 - 1,2
Z	Any other agreed composition		

Yield Strength, Tensile Strength and Elongation			
Symbol	ReL (N/mm <sup>2</sup> )	Rm (N/mm <sup>2</sup> )	A (%)
35	355	440-570	22
38	380	470-600	20
42	420	500-640	20
46	460	530-680	20
50	500	560-720	18

1) If not specified Mo<0,3; Ni<0,3; Cr<0,2; V<0,05; Nb<0,05; Cu<0,3  
 2) Single values shown in the table mean maximum values  
 3) The results shall be rounded to the same number of significant figures as in the specified value using the rules according to ISO 31-0, annex B rule A

Symbol for impact properties of all-weld metal (Min. 47J)

Symbol	Temperature °C
Z	No Requirements
A	(+20)
0	0
2	-20
3	-30
4	-40
5	-50
6	-60

Electrode covering

A	Acid covering
C	Cellulosic covering
R	Rutile covering
RR	Thick Rutile covering
RC	Rutile-Cellulosic covering
RA	Rutile-Acid cov.
RB	Rutile-Basic cov.
B	Basic covering

Symbol for weld metal recovery and type of current (%)

1	≤ 105	≠/r
2	≤ 105	=
3	> 105 ≤ 125	≠/r
4	> 105 ≤ 125	=
5	> 125 ≤ 160	≠/r
6	> 125 < 160	≠/r
7	> 160	≠/r
8	> 160	=

Symbols for welding positions

1	PA, PB, PC, PD, PE, PF, PG
2	PA, PB, PC, PD, PE, PF,
3	PA, PB
4	PA
5	PA, PB, PG

Symbols for hydrogen content of the all-weld metal

Symbol	ml/100g
H 5	5
H 10	10
H 15	15

**Table of the Electrodes for Welding of Non-alloy Steels according to AWS A5.1/A5.1M**

**E 60 1 3**

**Covered Electrode**

Symbol	Tensile Strength min.		Yield Strength min.	
	A5.1 (ksi)	A5.1 M (N/mm <sup>2</sup> )	A5.1 (ksi)	A5.1 M (N/mm <sup>2</sup> )
60	60	430	48	330
70	70	490	58	400

Symbol	Welding Positions
1	all welding positions
2	horizontal and flat welding positions
4	all welding positions including vertical down position

Symbol	Type of Cover	Welding Position	Current Type	Elongation %min.
10	Cellulosic-Sodium silicate	F, V, OH, H-fillet	DC (+)	22
11	Cellulosic-Potassium silicate	F, V, OH, H-fillet	AC - DC (+)	22
12	Rutile-Sodium silicate	F, V, OH, H-fillet	AC - DC (-)	17
13	Rutile-Potassium silicate	F, V, OH, H-fillet	AC - DC (-) (+)	17
14	Rutile-Iron powder	F, V, OH, H-fillet	AC - DC (-) (+)	17
15	Basic-Sodium silicate	F, V, OH, H-fillet	DC (+)	22
16	Basic-Potassium silicate	F, V, OH, H-fillet	AC - DC (+)	22
18	Basic, Iron powder-Potassium silicate	F, V, OH, H-fillet	AC - DC (+)	22
19	Rutile, Iron oxide-Potassium silicate	F, V, OH, H-fillet	AC - DC (-) (+)	22
20	Iron oxide	F, H-fillet	AC - DC (-) (+)	22
22	Iron oxide	only for one-run welding	AC - DC (-)	—
24	Rutile-Iron powder	F, H-fillet	AC - DC (-) (+)	17
27	Iron oxide - Iron powder	F, H-fillet	AC - DC (-) (+)	22
28	Basic, Iron powder - Potassium Silicate	F, H-fillet	AC - DC (+)	22
40	Basic, Iron powder - Potassium Silicate	F, OH, H, V-Down	AC - DC (+)	22

F=Flat                      V=Vertical    OH=Overhead    H=Horizontal  
 H-Fillets= Horizontal fillets    V-Down= Vertical with downward progression

**Table of High Strength Electrodes According to TS EN ISO 18275-A**

Production / Product	Yield Strength, Tensile Strength, Elongation Symbol (Rel. (N/mm <sup>2</sup> )) (Rm (N/mm <sup>2</sup> )) (A, %)	E	69	6	Mn2NiCrMo	B	3	4	H5	Electrode covering
G Wire Electrodes										A Cellulosic covering
H Cored wires										C Cellulosic covering
I Electrodes for welding	55 550 610-760 18									R Rutile covering
J Submerged arc welding wires	62 620 650-850 18									RR Thick Rutile covering
K Flux cored wires	69 690 750-900 17									RC Rutile-Cellulosic covering
L Flux cored wires	73 700 880-1080 18									RA Rutile-Acid cov.
M TIG Flux cored wires	88 890 980-1180 18									RB Rutile-Basic cov.
N Submerged arc welding fluxes										B Basic covering
<b>Symbol for impact properties of all-weld metal min. 47J</b>										
Symbol	Temperature °C									
Z	No Requirements (+20)									1 PA, PB, PC, PD, PE, PF, PG
A	0									2 PA, PB, PC, PD, PE, PF
0	0									3 PA, PB, PC
2	-20									4 PA, PB
3	-30									5 PA, PB, PG
4	-40									
5	-50									
6	-60									
7	-70									
8	-80									
<b>Symbol for weld metal recovery and type of current (%)</b>										
1	105	≡								
2	105	≡								
3	> 105 ≤ 125	≡								
4	> 105 ≤ 125	≡								
5	> 125 ≤ 160	≡								
6	> 125 ≤ 160	≡								
7	> 160	≡								
8	> 160	≡								
<b>Symbol for hydrogen content of the all-weld metal</b>										
Symbol	ml/100g									
H5	5									
H 10	10									

## Table for Creep - Resisting (Heat - Resisting) Electrodes According to TS EN ISO 3580-A

Alloy Symbol	Chemical Composition % 1) 2) 3) Mass											Yield Strength ReL [N/mm <sup>2</sup> ]	Tensile Strength Rm [N/mm <sup>2</sup> ]	Elongation A <sub>5</sub> [%]	Impact Strength J	Post Weld Heat Treatment °C	
	C	Si	Mn	P	S	Cr	Mo	V	Ni	Al	Hf						
Mo	0.10	0.80	0.02-0.040	0.03	0.025	—	0.42-0.70	—	—	—	—	355	510	22	47	570-620	60
MoV	0.03-0.12	0.80	0.40-1.20	0.03	0.025	0.30-0.100	0.15-0.60	0.25-0.60	—	—	—	365	510	18	47	600-730	60
CrMo0.5	0.05-0.12	0.80	0.40-1.20	0.03	0.025	0.40-0.85	0.40-0.65	—	—	—	—	365	510	22	47	600-550	60
CrMo1	0.09-0.12	0.90	0.40-1.50-1.1	0.03	0.025	0.50-1.40	0.45-0.70	—	—	—	—	385	510	20	47	660-700	60
CrMo1L	0.05	0.80	0.40-1.040	0.03	0.025	0.60-1.40	0.45-0.70	—	—	—	—	355	510	20	47	660-700	60
CrMoV1	0.05-0.15	0.80	0.40-1.30	0.03	0.025	0.60-1.30	0.50-1.30	0.10-0.30	—	—	—	435	590	15	47	660-730	60
CrMo2	0.05-0.12	0.80	0.60-1.30	0.03	0.025	2.0-2.8	0.50-1.30	—	—	—	—	400	500	18	47	650-750	60
CrMo2L	0.05	0.80	0.40-1.30	0.025	0.025	2.0-2.5	0.50-1.30	—	—	—	—	400	500	18	47	600-750	60
CrMo5	0.03-0.12	0.80	0.40-1.50	0.025	0.025	4.0-6.0	0.40-0.70	—	—	—	—	400	590	17	47	730-760	60
CrMo5B	0.03-0.12	0.80	0.40-1.30	0.025	0.025	8.0-10.0	0.40-1.2	0.15	Ni 0.40-1.00 Nb 0.04-0.10 N 0.02-0.07	—	—	435	550	16	34	740-780	60
CrMo91	0.06-0.12	0.60	0.40-1.50	0.025	0.025	8.0-10.0	0.50-1.30	0.15-0.30	—	—	—	415	495	17	47	730-770	120-180
CrMoVV12	0.10-0.22	0.90	0.40-1.30	0.025	0.025	10.0-12.0	0.60-1.30	0.20-0.40	—	—	—	550	650	16	34	740-780	60
Z	Any other agreed composition											550	650	16	34	740-780	60

### Electrode covering

A	Acid covering
C	Cellulosic covering
R	Rutile covering
RR	Thick Rutile covering
RC	Rutile-Cellulosic covering
RA	Rutile-Acid cov.
RB	Rutile-Basic cov.
B	Basic covering

Symbols for wetting positions	
1	PA, PB, PC, PD, PE, PF, PG
2	PA, PB, PC, PD, PE, PF
3	PA, PB, PC
4	PA, PE
5	PA, PB, PG

Symbol for hydrogen content of the air-weld metal	
Symbol	m/100g
H 1	5
H 10	10

Symbol for weld metal recovery and type of current (%)	
1	105
2	105
3	> 105 < 125
4	> 105 < 125

In order to demonstrate comparability on a.c., tests shall be carried out with no voltage no higher than 65V

Production / Product	
G	Wire Electrodes
C	One-substrate
E	Elastic arc welding
S	Stainless steel arc welding wires
T	Flat-stapled wires
W	TIG Rods
F	Stainless steel arc welding fluxes

- 1) If not specified Ni <= 0.3, Cu <= 0.3, V <= 0.03, Nb <= 0.01, Cr <= 0.2.
- 2) Single values shown in the table mean maximum values
- 3) The results shall be rounded to the same number of significant figures as in the specified value using the rules according to ISO 31-0, annex B rule A

## Table of the Low-Alloy Electrodes According to AWS A5.5

**E 80 1 8 - B2**

### Covered Electrode

Symbol	Tensile Strength		Yield Strength	
	(Nk)	(N/mm <sup>2</sup> )	(Nk)	(N/mm <sup>2</sup> )
70	75	480	60	415
80	85	520	67	460
86	93	605	77	530
100	108	690	87	600
110	116	730	97	670
120	126	830	107	740

1	All Welding Positions
2	Horizontal and flat welding positions

Symbol	Type of Cover	Welding Position	Type of Current
10	Cellulosic Sodium Silicate	F, V, OH H-fillet	DC (+)
11	Cellulosic Potassium Silicate	F, V, OH H-fillet	AC DC (+)
13	Rutile Potassium Silicate	F, V, OH H-fillet	AC DC (-) (+)
15	Basic Sodium Silicate	F, V, OH H-fillet	DC (-)
16	Basic Potassium Silicate	F, V, OH H-fillet	AC DC (+)
18	Basic Iron Powder Potassium Silicate	F, V, OH H-fillet	AC DC (+)
20	Iron Oxide	F, H-fillet	AC DC (-) (+)
27	Iron Oxide Iron Powder	F, H-fillet	AC DC (-) (+)

F=Flat V=Vertical OH=Overhead  
H=Horizontal H-Fillets= Horizontal fillets  
V-Down= Vertical with downward progression

Symbol	Elongation % min.	
E 7010	P1A1G	22/22/22
E 7011	A1G	22/22
E 7015	X/B2L/G	25/19/25
E 7016	X/B2L/G	25/19/25
E 7018	X/B2L/C3/W1G	25/19/25/25/25
E 7020	A1G	25/25
E 7027	A1G	22/25
E 8010	P1G	19/19
E 8011	G	16
E 8013	G	16
E 8015	X/B3L/G	19/17/19
E 8016	X/C3/C4/G	16/24/16/19
E 8018	X/B3L/C3/C4/NI1/W2/G	19/17/24/19/19/19/19
E 9010	G	17
E 9011	G	17
E 9013	G	14
E 9015	X/G	17/17
E 9016	X/G	17/17
E 9018	M/X/G	24/17/17
E 10010	G	16
E 10011	G	16
E 10013	G	15
E 10015	X/G	16/16
E 10016	X/G	16/16
E 10018	M/X/G	20/16/16
E 11010	G	15
E 11011	G	15
E 11013	G	13
E 11015	G	15
E 11016	G	15
E 11018	M	20
E 12010	G	14
E 12011	G	14
E 12013	G	11
E 12015	G	14
E 12016	G	16
E 12018	G/M/M1	14/18/18

\*X' : B1, B2, B3, B4L, B5, B6, B6L, B7, B7L, B8, B8L, B9, C1, C1L, C2, C2L, C5L, D1, D2, D3, P1

Symbol	Types of Electrodes	Chemical Composition of the Weld Metals %				
		C	Mn	Ni	Cr	Mo
E6000-A1	Carbon molybdenum alloyed	0.12	0.90	—	—	0.40-0.65
E6000-A1		0.05-0.12	0.30	—	0.40-0.65	0.40-0.65
E6000-B2		0.05-0.12	0.30	—	1.00-1.30	0.40-0.65
E6000-B3		0.05-0.12	0.30	—	2.00-2.50	0.95-1.20
E6000-B4L		0.05	0.30	—	1.75-2.25	0.45-0.65
E6000-B8		0.07-0.15	0.40-0.70	—	0.45-0.60	1.00-1.25
E6000-B8		0.05-0.10	1.00	0.40	4.00-6.00	0.45-0.65
E6000-B7		0.05-0.18	1.50	0.40	0.50-0.60	0.45-0.65
E6000-B8		0.05-0.18	1.50	0.40	0.50-10.5	0.45-1.20
E6000-B9		0.06-0.13	1.25	1.60	0.50-10.5	0.85-1.20
E6000-C1	Nickel alloyed	0.12	1.25	2.00-2.75	—	—
E6000-C2		0.12	1.25	3.00-3.75	—	—
E6000-C3		0.13	0.40-1.25	0.60-1.30	0.15	0.30
E6000-C4		0.10	1.25	1.10-2.00	—	—
E6000-C5		0.09	0.40-1.00	0.20-0.25	—	—
E6000-NM1	Nickel molybdenum alloyed	0.10	0.80-1.25	0.60-1.10	0.10	0.60-0.85
E6000-D1		0.12	1.00-1.75	0.90	—	0.25-0.40
E6000-D2	Manganese molybdenum alloyed	0.15	1.05-2.00	0.90	—	0.25-0.40
E6000-D3		0.12	1.05-1.80	0.90	—	0.40-0.60
X600-0	Low alloy electrode	Mn: 1.00 - Si: 0.80 - Ni: 0.50 - Cr: 0.30 Mo: 0.20 V: 0.10 When at least one of these elements exceeds the limit, designated with "G".				
E6000-M	Military similar electrode	0.10	0.60-1.25	1.40-1.90	0.15	0.30
E6000-P1	Pipeline electrodes	0.20	1.20	1.00	0.30	0.50
E6000-W1	Weathering steel electrodes	0.12	0.40-0.70	0.20-0.40	0.15-0.20	0.01-0.06
E6000-W2		0.12	0.50-1.30	0.40-0.80	0.45-0.70	0.01-0.075

The symbol L is added to the low-carbon electrodes.

## Table of Covered Electrodes for Manual Arc Welding of Heat-Resisting and Stainless Steels According to TS EN ISO 3581-A

			E			R			4				
			19 12 3 Nb										
Symbol of alloy	Chemical Composition % 1) 2)									Mechanical Properties			
	C	Mn	P	S	Cr	Ni	Nb	Mo	Other Elements	Tensile Strength	Yield Strength	Tensile Elongation %	Root weld Heat Treatment
<b>Martensitic / Ferritic</b>													
13	0.12	1.00	0.028	0.025	13.0-14.5	0.0-0.69	0.6-7.8			500	490	18	SUBHEATED 800°C/2h SOLANQUE 1010/1h
13 A	0.08	1.00	0.025	0.025	13.0-14.5	0.0-1.50	0.4-3.9			500	378	18	ISO 25225 1000°C/2h
17	0.17	1.00	0.028	0.025	16.5-18.5	0.0-0.80	0.6-7.8			500	462	18	
<b>19 Ferritic</b>													
19	0.08	1.20	0.028	0.025	19.3-21.9	0.0-1.19	0.6-7.8			500	505	20	NONE
19 A	0.08	1.20	0.028	0.025	19.3-21.9	0.0-1.19	0.6-7.8			500	514	20	NONE
19 B	0.08	1.20	0.028	0.025	19.3-21.9	0.0-1.19	0.6-7.8			500	506	20	NONE
19 B Nb	0.08	1.20	0.028	0.025	19.3-21.9	0.0-1.50	2.1-3.9	Mo min. 0.4 % max. 0.11		500	506	20	NONE
19 B Ti	0.08	1.20	0.028	0.025	19.3-21.9	0.0-1.50	2.1-3.9	Mo min. 0.4 % max. 0.11 Ti 0.020-0.035		500	512	22	NONE
19 B Ti Nb	0.08	1.20	0.028	0.025	19.3-21.9	0.0-1.50	2.1-3.9	Mo min. 0.4 % max. 0.11 Ti 0.020-0.035 Nb 0.010-0.030		500	508	22	NONE
19 B Ti Nb Ti	0.08	1.20	0.028	0.025	19.3-21.9	0.0-1.50	2.1-3.9	Mo min. 0.4 % max. 0.11 Ti 0.020-0.035 Nb 0.010-0.030		500	508	22	NONE
19 B Ti Nb Ti Nb	0.08	1.20	0.028	0.025	19.3-21.9	0.0-1.50	2.1-3.9	Mo min. 0.4 % max. 0.11 Ti 0.020-0.035 Nb 0.010-0.030		500	508	22	NONE
<b>Austenitic / Ferritic</b>													
High chromium resistance													
22 B 9 M	0.04	1.20	0.028	0.025	21.9-24.4	7.3-10.3	2.4-4.9	Mo 0.01-0.025		600	600	22	NONE
22 B 9 M L	0.04	1.20	0.028	0.025	21.9-24.4	7.3-10.3	2.4-4.9	Mo 0.01-0.025		600	580	18	NONE
22 B 9 M Nb	0.04	1.20	0.028	0.025	21.9-24.4	7.3-10.3	2.1-4.5	Mo 0.01-0.025		600	620	18	NONE
25 B 8 A M L	0.04	1.20	0.028	0.025	24.8-27.2	8.0-10.5	2.1-4.5	Mo 0.10-0.35		600	620	18	NONE
<b>Austenitic / Ferritic</b>													
High chromium resistance													
19 15 3 L	0.04	1.20	0.028	0.025	16.5-18.5	14.0-17.0	2.1-3.1			500	480	25	NONE
19 15 3 L Nb	0.04	1.20	0.028	0.025	16.5-18.5	14.0-17.0	2.1-3.1			500	480	25	NONE
20 25 3 5 0.4 N L	0.04	1.20	0.028	0.025	19.3-22.2	24.0-27.0	4.8-7.3	Mo 0.70		500	510	25	NONE
20 16 16 0.8 M L	0.04	1.20	0.028	0.025	16.5-18.5	16.0-18.0	2.1-3.1	Mo 0.20		500	510	25	NONE
25 27 2 3 L	0.04	1.20	0.028	0.025	24.8-27.2	20.0-23.0	2.7-3.9	Mo 0.20		500	510	25	NONE
27 31 4 5 0.1 L	0.04	1.20	0.028	0.025	28.9-29.1	30.0-30.0	3.7-4.5	Co 0.5-1.5		540	500	25	NONE
<b>Special Types</b>													
19 B 9 M <sup>3)</sup>	0.20	4.5-7.5	0.028	0.025	17.9-20.0	1.0-50.0				280	300	25	NONE
19 B 9 M <sup>4)</sup>	0.04-0.14	3.5-2.5	0.028	0.025	16.5-21.1	0.0-1.9	0.5-1.5			300	300	22	NONE
20 B 15 M	0.10	1.20	0.028	0.025	19.3-21.1	0.0-1.5	0.5-1.5			400	400	22	NONE
20 B 15 L	0.04	1.20	0.028	0.025	19.3-21.1	0.0-1.5	0.5-1.5			400	420	22	NONE
23 B 12 Nb	0.18	1.20	0.028	0.025	22.9-25.2	17.0-24.2	0.7-1.9			378	510	21	NONE
23 B 12 Nb Nb	0.18	1.20	0.028	0.025	22.9-25.2	17.0-24.2	0.7-1.9			378	508	21	NONE
23 B 12 Ti	0.18	1.20	0.028	0.025	22.9-25.2	17.0-24.2	0.7-1.9			378	510	21	NONE
23 B 12 Ti Nb	0.18	1.20	0.028	0.025	22.9-25.2	17.0-24.2	0.7-1.9			378	510	21	NONE
23 B 12 Ti Nb Ti	0.18	1.20	0.028	0.025	22.9-25.2	17.0-24.2	0.7-1.9			378	510	21	NONE
23 B 12 Ti Nb Ti Nb	0.18	1.20	0.028	0.025	22.9-25.2	17.0-24.2	0.7-1.9			378	510	21	NONE
23 B 12 Ti Nb Ti Nb Ti	0.18	1.20	0.028	0.025	22.9-25.2	17.0-24.2	0.7-1.9			378	510	21	NONE
<b>19 B 9 M<sup>5)</sup> Special Types</b>													
19 B 9 M <sup>5)</sup>	0.04	0.08	0.028	0.025	16.5-18.5	0.0-1.19	0.5-2.5			528	510	22	NONE
19 B 9 M <sup>6)</sup>	0.04-0.08	1.20	0.028	0.025	24.0-27.0	0.0-1.19	0.0-1.9			500	500	22	NONE
25 B 4	0.05	1.20	0.028	0.025	24.8-27.2	4.6-5.8	0.0-1.9			406	600	5	NONE
25 B 4 Nb	0.05	1.20	0.028	0.025	24.8-27.2	4.6-5.8	0.0-1.9			406	600	5	NONE
25 B 4 Ti	0.05	1.20	0.028	0.025	24.8-27.2	4.6-5.8	0.0-1.9			406	600	5	NONE
25 B 4 Ti Nb	0.05	1.20	0.028	0.025	24.8-27.2	4.6-5.8	0.0-1.9			406	600	5	NONE
25 B 4 Ti Nb Ti	0.05	1.20	0.028	0.025	24.8-27.2	4.6-5.8	0.0-1.9			406	600	5	NONE
25 B 4 Ti Nb Ti Nb	0.05	1.20	0.028	0.025	24.8-27.2	4.6-5.8	0.0-1.9			406	600	5	NONE
25 B 4 Ti Nb Ti Nb Ti	0.05	1.20	0.028	0.025	24.8-27.2	4.6-5.8	0.0-1.9			406	600	5	NONE
19 B 9 M <sup>7)</sup>	0.07	1.05	0.028	0.025	16.0-18.2	2.00-3.71	0.70			336	500	15	NONE

Symbol for weld position	
1	PA, PB, PC, PD, PE, PF, PG, PH
2	PA, PB, PC, PD, PE, PF, PG, PH
3	PA, PB, PC, PD, PE, PF, PG, PH
4	PA, PB, PC, PD, PE, PF, PG, PH

Symbol for weld metal (reference type of material %)	
1	E 1108
2	E 1109
3	E 1108 + 1.02
4	E 1108 + 1.02 + 0.15
5	E 1108 + 1.02 + 0.15 + 0.05
6	E 1108 + 1.02 + 0.15 + 0.05 + 0.02
7	E 1108 + 1.02 + 0.15 + 0.05 + 0.02 + 0.01
8	E 1108 + 1.02 + 0.15 + 0.05 + 0.02 + 0.01 + 0.005

Electrode Covering	
R	R - Rutile Cox.
B	B - Basic Cox.

Production / Product	
D	Wire Electrodes
E	Oxyacetylene
O	Electric arc welding
S	Shielded metal arc welding
T	Flux-cored wire
W	TIG Rods
F	Shielding fluxes

## Table of Stainless Steel Electrodes According to AWS A5.4

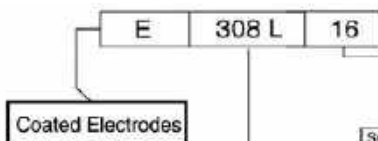

Symbol	Current type	Welding Position
15	DC (+)	All
16	AC,DC (+)	Welding Position
17	AC,DC (+)	Horizontal, flat and horizontal vertical
25	DC (+)	Horizontal, flat and horizontal vertical
26	AC,DC (+)	Horizontal, flat and horizontal vertical

Symbol	Chemical Composition of Weld Metal %						Mechanical Properties	
	C	Si	Mn	Cr	Ni	Mo	Tensile Strength	Elongation min. %
E 209 <sup>1)</sup>	0.06	0.90	4.0 - 7.0	20.5 - 24.0	9.5 - 12.0	1.5 - 3.0	690	15
E 219 <sup>1)</sup>	0.06	1.00	8.0 - 10.0	19.0 - 21.5	5.5 - 7.0	0.75	620	15
E 240 <sup>1)</sup>	0.06	1.00	10.5 - 13.5	17.0 - 19.0	4.0 - 6.0	0.75	690	15
E 307	0.04 - 0.14	0.90	3.30 - 4.75	18.0 - 21.5	9.0 - 10.7	0.5 - 1.5	590	30
E 308	0.08	0.90	0.5 - 2.5	18.0 - 21.0	9.0 - 11.0	0.75	550	35
F 308 H	0.04 - 0.08	0.90	0.5 - 2.5	18.0 - 21.0	9.0 - 11.0	0.75	550	35
E 308 L	0.04	0.90	0.5 - 2.5	18.0 - 21.0	9.0 - 11.0	0.75	520	35
E 308 Mo	0.06	0.90	0.5 - 2.5	18.0 - 21.0	9.0 - 12.0	2.0 - 3.0	550	35
E 308 MoL	0.04	0.90	0.5 - 2.5	18.0 - 21.0	9.0 - 12.0	2.0 - 3.0	520	35
E 309	0.16	0.90	0.5 - 2.5	22.0 - 25.0	12.0 - 14.0	0.75	550	30
E 309 L	0.04	0.90	0.5 - 2.5	22.0 - 25.0	12.0 - 14.0	0.75	520	30
E 309 Cb <sup>3)</sup>	0.12	0.90	0.5 - 2.5	22.0 - 25.0	12.0 - 14.0	0.75	550	30
E 309 Mo	0.12	0.90	0.5 - 2.5	22.0 - 25.0	12.0 - 14.0	2.0 - 3.0	550	30
F 309 MoL	0.04	0.90	0.5 - 2.5	22.0 - 25.0	12.0 - 14.0	2.0 - 3.0	520	30
E 310	0.08 - 0.20	0.75	1.0 - 2.5	25.0 - 28.0	20.0 - 22.5	0.75	550	30
E 310 H	0.35 - 0.45	0.75	1.0 - 2.5	25.0 - 28.0	20.0 - 22.5	0.75	620	10
E 310 Cb <sup>3)</sup>	0.12	0.75	1.0 - 2.5	25.0 - 28.0	20.0 - 22.0	0.75	550	25
E 310 Mo	0.12	0.75	1.0 - 2.5	25.0 - 28.0	20.0 - 22.0	2.0 - 3.0	550	30
E 312	0.15	0.90	0.5 - 2.5	28.0 - 32.0	8.0 - 10.5	0.75	660	22
E 316	0.08	0.90	0.5 - 2.5	17.0 - 20.0	11.0 - 14.0	2.0 - 3.0	520	30
E 316 H	0.04 - 0.08	0.90	0.5 - 2.5	17.0 - 20.0	11.0 - 14.0	2.0 - 3.0	520	30
E 316 L	0.04	0.90	0.5 - 2.5	17.0 - 20.0	11.0 - 14.0	2.0 - 3.0	490	30
E 317	0.08	0.90	0.5 - 2.5	18.0 - 21.0	12.0 - 14.0	3.0 - 4.0	550	30
E 317 L	0.04	0.90	0.5 - 2.5	18.0 - 21.0	12.0 - 14.0	3.0 - 4.0	520	30
E 318 <sup>2)</sup>	0.08	0.90	0.5 - 2.5	17.0 - 20.0	11.0 - 14.0	2.0 - 3.0	550	25
E 320 <sup>2)</sup>	0.07	0.50	0.5 - 2.5	19.0 - 21.0	32.0 - 36.0	2.0 - 3.0	550	30
E 320 LR <sup>2)</sup>	0.03	0.30	1.50 - 2.5	19.0 - 21.0	32.0 - 36.0	2.0 - 3.0	520	30
E 330	0.18 - 0.25	0.90	1.0 - 2.5	14.0 - 17.0	33.0 - 37.0	0.75	520	25
E 330 H	0.35 - 0.45	0.90	1.0 - 2.5	14.0 - 17.0	33.0 - 37.0	0.75	620	10
F 347	0.08	0.90	0.5 - 2.5	18.0 - 21.0	9.0 - 11.0	0.75	520	30
E 349	0.13	0.90	0.5 - 2.5	18.0 - 21.0	8.0 - 10.0	0.35 - 0.65	690	25
E 383	0.03	0.90	0.5 - 2.5	26.5 - 29.0	30.0 - 33.0	3.2 - 4.2	520	30
E 385	0.03	0.75	1.0 - 2.5	19.5 - 21.5	24.0 - 26.0	4.2 - 5.2	520	30
E 410	0.12	0.90	1.0	11.0 - 13.5	0.7	0.75	450	20
E 410 NiMo	0.06	0.90	1.0	11.0 - 12.5	4.0 - 5.0	0.40 - 0.70	760	15
E 430	0.10	0.90	1.0	15.0 - 18.0	0.6	0.75	450	30
E 502	0.10	0.90	1.0	4.0 - 6.0	0.4	0.45 - 0.65	420	20
E 505	0.10	0.90	1.0	8.0 - 10.5	0.4	0.85 - 1.20	420	20
E 630 <sup>2)</sup>	0.05	0.75	0.25 - 0.75	16.00 - 16.75	4.5 - 5.0	0.75	930	7
E 16-8-2	0.10	0.80	0.5 - 2.5	14.5 - 16.5	7.5 - 9.5	1.0 - 2.0	550	35
E 7 Cr	0.10	0.90	1.0	6.0 - 8.0	0.4	0.45 - 0.65	420	20
E 2209 <sup>3)</sup>	0.04	0.90	0.5 - 2.0	21.5 - 23.5	8.5 - 10.5	2.5 - 3.5	690	20
E 2553 <sup>3)</sup>	0.06	1.0	0.5 - 1.5	24.0 - 27.0	6.5 - 8.5	2.9 - 3.9	760	15

- 1) Weld metal includes Ni.
- 2) Weld metal includes Cu.
- 3) Weld metal includes Cb (Nb)+Ta.

## Table of Cast Iron Electrodes According to TS EN ISO 1071

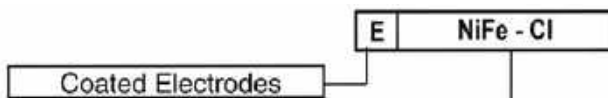

Symbol	Product Structure	Composition of the weld metal %									
		C	Si	Mn	P	S	Fe	Ni	Cu	Not	Other elements
<b>Coated Electrodes</b>											
Fe-1	E, S, T	2.0	1.5	0.5-1.5	0.04	0.04	rest	-	-	-	1.0
St	E, S, T	0.15	1.0	0.8	0.04	0.04	rest	-	0.35	-	0.4
Fe-2	E, T	0.2	1.5	0.3-1.5	0.04	0.04	rest	-	-	Nb+V 5.0-10.0	1.0
Ni-CI	E	2.0	4.0	2.5	-	0.03	8.0	min.85	2.5	Al: 1.0	2.0
	S	1.0	0.75	2.5	-	0.03	4.0	min.90	4.0	-	1.0
Ni-CI-A	E	2.0	4.0	2.5	-	0.03	8.0	min.85	2.5	Al: 1.0-3.0	1.0
NFe-1	E, S, T	2.0	4.0	2.5	0.03	0.03	rest	45-70	4.0	Al: 1.0	1.0
NFe-2	E, S, T	2.0	4.0	1.0-5.0	0.03	0.03	rest	45-60	2.5	elements that produce carbide 3,0	1.0
NiFe-CI	E	2.0	4.0	2.5	-	0.04	rest	40-60	2.5	Al: 1.0	1.0
NiFeT3-CI	T	2.0	1.0	3.0-5.0	-	0.03	rest	45-60	2.5	Al: 1.0	1.0
NiFeCI-A	E	2.0	4.0	2.5	-	0.03	rest	45-60	2.5	Al: 1.0-3.0	1.0
NiFeMn-CI	E	2.0	1.0	10.1	-	0.03	rest	35-45	2.5	Al: 1.0	1.0
	S	0.5	1.0	10-14	-	0.03	rest	35-45	2.5	Al: 1.0	1.0
NiCu	E, S, T	1.7	1.0	2.5	-	0.04	5.0	50-75	rest	-	1.0
NiCu-A	E, S	0.35-0.55	0.75	2.3	-	0.025	3.0-6.0	50-60	35-45	-	1.0
NiCu-B	E, S	0.35-0.55	0.75	2.3	-	0.025	3.0-6.0	60-70	25-35	-	1.0
Z	R, E, T	Any agreed composition									

Single values shown in the table mean maximum values unless noted otherwise.

Symbol	Abbreviation of the consumable	Tensile Strength	Yield Strength	Elongation
		MPa	MPa	%
Fe-1	E C Fe-1	No values, only for surface coating (intermediate transverse layers)		
St	E C St	No values, only for surface coating (intermediate transverse layers)		
Fe-2	E C Fe-2	320	440	8
	T C Fe-2			
Ni-CI	E C Ni-CI	200	250	3
	S C Ni-CI	200	250	3
Ni-CI-A	E C Ni-CI-A	200	250	3
NFe-1	E/S/T C NFe1	290	420	6
NFe-2	E/S/T C NFe2	290	420	6
NiFe-CI		250	350	6
NiFeT3-CI	T C NFeT3-CI	250	350	12
350 NiFe-CI-A	E C NiFeCI-A	250	350	4
NiFeMn-CI	E S NiFeMn-CI	350	450	10
	S C NiFeMn-CI	350	450	15
NiCu	E C NiCu	190	300	15

Symbol	Weld metal recovery rate (%)	Current Type
1	≤ 105	AC-DC
2	≤ 105	DC
3	> 105≤125	AC-DC
4	>105≤125	DC
5	>105≤125	AC-DC
6	>105≤125	DC
7	>160	AC-DC
8	>160	DC



### Table of Cast Iron Electrodes according to AWS A5.15

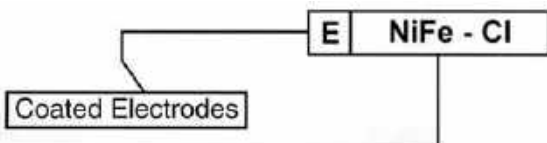

Symbol	Composition of the weld metal											Other elements	
	C	Mn	Si	P	S	Fe	Ni	Mo	Cu	Mg	Al		Cr
<b>Coated Electrodes</b>													
ENi-CI	2.00	2.50	4.00	—	0.03	6.00	min. 65	—	2.50	—	1.00	—	1.00
ENi-CI-A	2.00	2.50	4.00	—	0.03	6.00	min. 65	—	2.50	—	1.0-3.0	—	1.00
ENiFe-CI	2.00	2.50	4.00	—	0.03	Rest	45-60	—	2.50	—	1.00	—	1.00
ENiFe-CI-A	2.00	2.50	4.00	—	0.03	Rest	45-60	—	2.50	—	1.0-3.0	—	1.00
ENiFeMn-CI	2.00	10.0-14.0	1.00	—	0.03	Rest	35-45	—	2.50	—	1.00	—	1.00
ENiCu-A	0.35-0.55	2.30	0.75	—	0.025	3.0-6.0	50-60	—	35-45	—	—	—	1.00
ENiCu-B	0.35-0.55	2.30	0.75	—	0.025	3.0-6.0	60-70	—	25-35	—	—	—	1.00
<b>Flux-cored Wires</b>													
ENiFeT3-CI	2.00	3.0-5.0	1.00	—	0.03	Rest	45-60	—	2.50	—	1.00	—	1.00
<b>Core Wire</b>													
E Si	0.15	0.50	0.15	0.04	0.04	Rest	—	—	—	—	—	—	—
<b>Cast Iron Welding Rods for Oxy-acetylene Welding</b>													
RCI	3.2-3.5	0.60-0.75	2.7-3.0	0.50-0.75	0.10	Rest	eser	eser	—	—	—	—	—
RCI-A	3.2-3.5	0.50-0.70	2.0-2.5	0.20-0.40	0.10	Rest	1.2-1.6	0.25-0.45	—	—	—	—	—
RCI-B	3.2-4.6	0.10-0.40	3.3-3.8	0.05	0.015	Rest	0.50	—	—	0.04-0.10	—	0.20	—
<b>TIG Rods</b>													
ERNi-CI	1.00	2.50	0.75	—	0.02	4.00	min. 90	—	4.00	—	—	—	1.00
ERNiFeMn-CI	0.50	10.0-14.0	1.00	—	0.02	Rest	35-45	—	2.50	—	1.00	—	1.00

Symbol	Tensile Strength min.		Yield Strength min.		Elongation %	Hardness BHN
	(ksi)	(N/mm <sup>2</sup> )	(ksi)	(N/mm <sup>2</sup> )		
RCI	20-25	138-172	—	—	—	150-210
RCI-A	35-40	241-276	—	—	—	225-290
RCI-B (rayaski)	80-90	552-621	70-75	483-517	3.0-5.0	220-310
RCI-B (avsk)	50-60	345	40-45	276-310	5.0-15.0	150-200
E Si	—	—	—	—	—	250-400
ENi-CI	40-65	276-448	38-60	262-414	3.0-6.0	135-218
ENi-CI-A	40-65	276-448	36-60	252-414	3.0-6.0	135-218
ENiFe-CI	55-64	400-579	43-63	298-434	6.0-16.0	165-218
ENiFe-CI-A	55-64	400-579	43-63	298-434	4.0-12.0	165-218
ENiFeMn-CI	75-95	517-656	60-70	414-483	10.0-18.0	165-210
ENiFeT3-CI	65-80	448-552	40-55	276-379	12.0-20.0	150-165
ERNiFeMn-CI	75-100	517-689	65-80	448-552	15-35	165-210

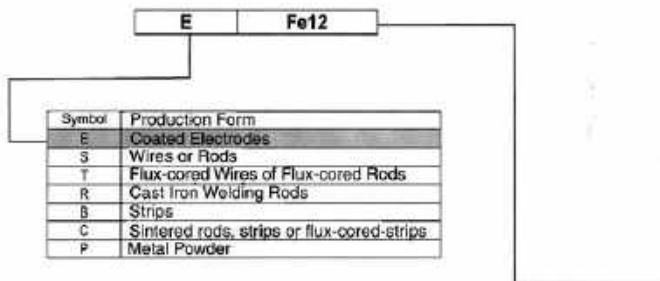
**Table of Electrodes for Hardfacing according to TS EN 14700**

Alloy Symbol	Acceptance	Chemical Composition %									
		C	Cr	Ni	Mn	Mo	W	V	Nb	other	rest
Fe1	p	≤0,4	≤3,5	—	0,5-3	≤1	≤1	≤1	—	—	Fe
Fe2	p	0,4-1,2	≤7	≤1	0,5-3	≤1	≤1	≤1	—	—	Fe
Fe3	st	0,2-0,5	1-8	≤5	≤3	≤4,5	≤10	≤1,5	—	Co, Si	Fe
Fe4	st (p)	0,2-1,5	2-6	≤4	≤3	≤10	≤19	≤4	—	Co, Si	Fe
Fe5	c p st w	≤0,5	≤0,1	17-22	≤1	3-5	—	—	—	Co, Ti	Fe
Fe6	g p s	≤2,5	≤10	—	≤3	≤3	—	—	≤10	Ti	Fe
Fe7	c p l	≤0,2	4-30	≤6	≤3	≤2	—	≤1	≤1	Si	Fe
Fe8	g p l	≤0,2-2	5-18	—	0,3-3	≤4,5	≤2	≤2	≤10	Si, Ti	Fe
Fe9	k (n) p	0,3-1,2	≤19	≤3	11-18	≤2	—	≤1	—	Ti	Fe
Fe10	ck (n) p z	≤0,25	17-22	7-11	3-8	≤1,5	—	—	≤1,5	Si	Fe
Fe11	cn z	≤0,3	18-31	8-20	≤3	≤4	—	—	≤1,5	Cu	Fe
<b>Fe12</b>	<b>c (n) z</b>	<b>≤0,03</b>	<b>17-28</b>	<b>10-28</b>	<b>0,5-3</b>	<b>≤4</b>	<b>—</b>	<b>—</b>	<b>≤1,5</b>	<b>—</b>	<b>Fe</b>
Fe13	G	≤1,5	≤6,5	≤4	0,5-3	≤4	—	—	—	B, Ti	Fe
Fe14	g (c)	1,5-4,5	25-40	≤4	0,5-3	≤4	—	—	—	—	Fe
Fe15	g	4,5-5,5	20-40	≤4	0,5-3	≤2	—	—	≤10	B	Fe
Fe16	g z	4,0-7,5	10-40	—	≤3	≤9	≤8	≤10	≤10	B, Co	Fe
Fe20	c g t z	hardfacing mat.	—	—	—	—	—	—	—	—	Fe
N1	c p l	≤1	15-30	rest	0,3-1	≤6	≤2	≤1	—	Si, Fe, B	Ni
N2	ck p t z	≤0,1	15-30	rest	≤1,5	≤28	≤8	≤1	≤4	Co, Si, Ti	Ni
N3	c p l	≤1	1-15	rest	0,3-1	≤6	≤2	≤1	—	Si, Fe, B	Ni
N4	ck p t z	≤0,1	1-15	rest	≤1,5	≤28	≤8	≤1	≤4	Co, Si, Ti	Ni
N20	c g t z	hardfacing mat.	—	—	—	—	—	—	—	—	Ni
Co1	ck t z	≤0,6	≤0,6	20-30	≤10	≤10	≤15	—	—	Fe	Co
Co2	tz (cs)	0,6-3	20-35	≤4	0,1-2	—	6-14	—	—	Fe	Co
Co3	tz (cs)	1-3	20-35	≤4	≤2	≤1	6-14	—	—	Fe	Co
Cu1	c (n)	—	—	≤6	≤15	—	—	—	—	Al, Fe, Sn	Cu
Al1	cn	—	—	—	10-35	≤0,5	—	—	—	Cu, Si	Al
Cr1	cg	1-5	rest	—	≤1	—	—	15-30	—	Fe, B, Si, Zr	Cr

Acceptance: c: corrosion resistance n: non-magnetized t: heat resisting  
g: abrasion resisting p: impact resisting z: oxidation resisting  
k: working hardening s: shearing ability w: precipitation hardening

a) Analyses that do not fit this table is signified with z.

## Table of Surfacing Electrodes according to AWS A5.13

**E FeMn-A**

Symbol	UNS Number	Chemical Composition %										Other	Fe	Other elements total
		C	Mn	Si	Cr	Ni	Mo	V	W					
<b>IRON BASE SURFACING ELECTRODES<sup>a)</sup></b>														
EFe1	W74001	0,04-0,20	0,5-2,0	1,0	0,5-3,5	—	1,5	—	—	—	—	rest	1,0	
EFe2	W74002	0,10-0,30	0,0-2,0	1,0	1,8-3,8	1,0	1,0	0,35	—	—	—	rest	1,0	
EFe3	W74003	0,50-0,80	0,5-1,5	1,0	4,0-8,0	—	1,0	—	—	—	—	rest	1,0	
EFe4	W74004	1,0-2,0	0,5-2,0	1,0	3,0-5,0	—	—	—	—	—	—	rest	1,0	
EFe5	W75110	0,30-0,80	1,5-2,5	0,90	1,5-3,0	—	7,0-9,5	0,5-1,5	0,5-1,5	—	—	rest	1,0	
EFe6	W77510	0,6-1,0	0,4-1,0	1,0	3,0-5,0	—	7,0-9,5	0,5-1,5	0,5-1,5	—	—	rest	1,0	
EFe7	W77610	1,5-3,0	0,5-2,0	1,5	4,0-8,0	—	1,0	—	—	—	—	rest	1,0	
EFeMn-A	W79110	0,5-1,0	12-16	1,3	—	—	2,5-5,0	—	—	—	—	rest	1,0	
EFeMn-B	W79310	0,5-1,0	12-16	1,3	—	—	0,5-1,5	—	—	—	—	rest	1,0	
EFeMn-C	W79210	0,5-1,0	12-16	1,3	2,5-5,0	2,85-5,0	—	—	—	—	—	rest	1,0	
EFeMn-D	W79410	0,5-1,0	15-20	1,3	4,5-7,5	—	—	0,4-1,2	—	—	—	rest	1,0	
EFeMn-E	W79510	0,5-1,0	15-20	1,3	3,0-6,0	1,0	—	—	—	—	—	rest	1,0	
EFeMn-F	W79610	0,8-1,2	17-21	1,3	3,0-6,0	1,0	—	—	—	—	—	rest	1,0	
EFeMnCr	W79710	0,25-0,75	12-18	1,3	13-17	0,5-2,0	2,0	1,0	—	—	—	rest	1,0	
EFeCr-A1-A	W74011	3,5-4,5	4,0-6,0	0,5-2,0	20-25	—	0,5	—	—	—	—	rest	1,0	
EFeCr-A2	W74012	2,5-3,5	0,5-1,5	0,5-1,5	7,5-9,0	—	—	—	—	—	Ti 1,2-1,8	rest	1,0	
EFeCr-A3	W74013	2,5-4,5	0,5-2,0	1,0-2,5	14-20	—	1,5	—	—	—	—	rest	1,0	
EFeCr-A4	W74014	3,5-4,5	1,5-3,5	1,5	23-29	—	1,0-3,0	—	—	—	—	rest	1,0	
EFeCr-A5	W74015	1,5-2,5	0,5-1,5	2,0	24-32	4,0	4,0	—	—	—	—	rest	1,0	
EFeCr-A6	W74016	2,5-3,5	0,5-1,5	1,0-2,5	24-30	—	0,5-2,0	—	—	—	—	rest	1,0	
EFeCr-A7	W74017	3,5-5,0	0,5-1,5	0,5-2,5	23-30	—	2,0-4,5	—	—	—	—	rest	1,0	
EFeCr-A8	W74018	2,5-4,5	0,5-1,5	1,5	30-40	—	2,0	—	—	—	—	rest	1,0	
EFeCr-E1	W74211	5,0-6,5	2,0-3,0	0,8-1,3	12-16	—	—	—	—	—	Ti 4,0-7,0	rest	1,0	
EFeCr-E2	W74212	4,0-6,0	0,5-1,5	1,5	14-20	—	5,0-7,0	1,5	—	—	—	rest	1,0	
EFeCr-E3	W74213	5,0-7,0	0,5-2,0	0,5-2,0	18-28	—	5,0-7,0	—	3,0-5,0	—	—	rest	1,0	
EFeCr-E4	W74214	4,0-6,0	0,5-1,5	1,0	20-30	—	5,0-7,0	0,5-1,5	2,0	—	Nb 4,0-7,0	rest	1,0	

a) Sulfur and phosphorus contents each shall not exceed 0.035%.

### Nickel and Cobalt Base Surfacing Electrodes

Symbol	UNS Number	C	Mn	Si	Cr	Ni	Mo	Fe	W	other	Co	Other elements total
ENiCoCr-A	W73008	0,7-1,4	2,0	2,0	25-32	3,0	1,0	5,0	3,0-6,0	—	rest	1,0
ENiCoCr-B	W73012	1,0-1,7	2,0	2,0	25-32	3,0	1,0	5,0	7,0-9,5	—	rest	1,0
ENiCoCr-C	W73001	1,7-3,0	2,0	2,0	25-33	3,0	1,0	5,0	11-14	—	rest	1,0
ENiCoCr-E	W73021	0,15-0,4	1,5	2,0	24-26	2,0-4,0	4,5-6,5	5,0	0,50	—	rest	1,0
ENiCoCr-C	W89606	0,5-1,0	—	3,5-5,5	12-18	rest	—	3,5-5,5	—	B 2,5-4,5	1,0	1,0
ENiCoMn-SA	W80002	0,12	1,0	1,0	14-18	rest	14-18	4,0-7,0	3,0-5,0	V 0,40	—	1,0
ENiCoCrFeCo	W83002	2,2-3,0	1,0	0,8-1,5	25-30	10-33	7,0-10	20-25	2,0-4,0	—	10-15	1,0

b) Sulfur and phosphorus contents each shall not exceed 0.03%.

## Table of Wire Electrodes and Deposits for Gas-shielded Arc Welding of Non-alloy and Fine-grain Steels according to

### TS EN ISO 14341-A

G 42 3 M G3Si1

Alloy Symbol	Chemical Composition % (1) (2)								
	C	Si	Mn	P	S	Ni	Mo	Al	Ti+Zr
GO	0,06-0,14								
G2Si	0,06-0,14	0,50-0,80	0,90-1,30	0,025	0,025	0,15	0,15	0,02	0,15
G3Si1	0,06-0,14	0,70-1,00	1,30-1,60	0,025	0,025	0,15	0,15	0,02	0,15
G4Si1	0,06-0,14	0,80-1,20	1,60-1,90	0,025	0,025	0,15	0,15	0,02	0,15
G3Si2	0,06-0,14	1,00-1,30	1,30-1,60	0,025	0,025	0,15	0,15	0,02	0,15
G2Ti	0,04-0,14	0,40-0,80	0,90-1,40	0,025	0,025	0,15	0,15	0,06-0,20	0,06-0,25
G3Ni1	0,06-0,14	0,50-0,90	1,00-1,60	0,025	0,025	0,80-0,15	0,15	0,02	0,15
G2Ni2	0,06-0,14	0,40-0,80	0,80-1,40	0,025	0,025	2,10-2,70	0,15	0,02	0,15
G2Mo	0,06-0,14	0,30-0,70	0,90-1,30	0,025	0,025	0,15	0,40-0,60	0,02	0,15
G4Mo	0,06-0,14	0,50-0,90	1,70-2,10	0,025	0,025	0,15	0,40-0,60	0,02	0,15
G2Al	0,06-0,14	0,30-0,50	0,90-1,30	0,025	0,025	0,15	0,15	0,35-0,75	0,15

1) Single values shown in the table mean maximum values.  
2) If not specified, Cr < %0,15, Cu %0,35 and V %0,03.

Production / Product	
G	Wire Electrodes
O	Oxy-acetylene
E	Electric arc welding
S	Submerged arc welding wires
T	Flux-cored wires
W	TIG Rods
F	Submerged arc welding fluxes

Symbol for impact properties of all-weld metal	
Symbol	Temperature °C
Z	No Requirements
A	(+20)
0	0
2	-20
3	-30
4	-40
5	-50
6	-60
7	-70
8	-80

Yield Strength, Tensile Strength and Elongation			
Symbol	ReL (N/mm <sup>2</sup> )	Rm (N/mm <sup>2</sup> )	A (%)
35	355	440-570	22
38	380	470-600	20
42	420	500-640	20
46	460	530-690	20
50	500	560-720	18
55	550	610-780	18
62	620	690-890	18
69	690	760-960	17
79	790	880-1080	16
89	890	980-1180	15

Shielding Gas EN 439	
M	Composition
C	CO <sub>2</sub>
N	No Gas

## Table of Carbon Steel Electrodes and Rods for Gas Shielded Arc Welding (TIG, MIG) of Non- Alloy Steels according to AWS A5.18

Chemical Compositions for Solid and Stick Electrodes (%) (a)															
	A 5.18M	UNS Number	C	Mn	Si	P	S	Ni	Mo	Cu	Ti	Zr	Al		
ER 70S-2	ER 48S-2	K10726	0,07	0,90-1,40	0,40-0,70	0,025	0,035	0,15	0,15	0,15	0,03	0,50	0,05-0,15	0,02-0,12	0,05-0,15
ER 70S-3	ER 48S-3	K11022	0,06-0,15	0,90-1,40	0,45-0,75	0,025	0,035	0,15	0,15	0,15	0,03	0,50	-	-	-
ER 70S-4	ER 48S-4	K11132	0,06-0,15	1,00-1,50	0,55-0,85	0,025	0,035	0,15	0,15	0,15	0,03	0,50	-	-	-
ER 70S-6	ER 48S-6	K11140	0,06-0,15	1,40-1,85	0,80-1,15	-	-	0,15	0,15	0,15	0,03	0,50	-	-	-
ER 70S-7	ER 48S-7	K11125	0,07-0,15	1,50-2,00	0,50-0,80	0,025	0,035	0,15	0,15	0,15	0,03	0,50	-	-	-
ER 70S-G	ER 48S-G	-	Not Specified												

a) Single values shown in the table mean maximum values.

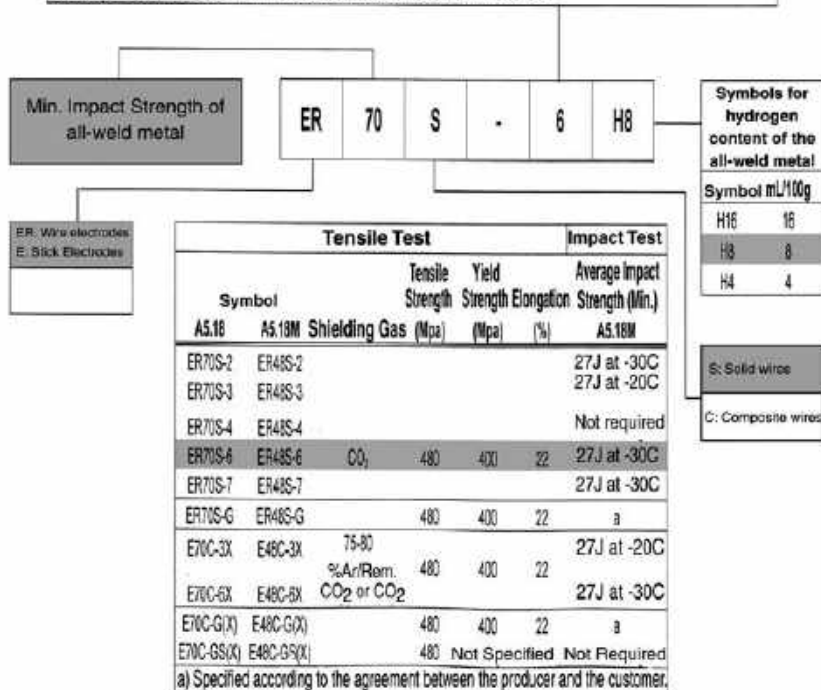

**Table of Wire Electrodes, Wires and Rods for Arc Welding of  
Creep-Resisting Steels according to TS EN ISO 21952-A**

Alloy Symbols	Chemical Composition										Mechanical Properties						
	C	Si	Mn	P	S	Cr	Mo	V	Other Elements	Yield Strength (Min.) N/mm <sup>2</sup>	Tensile Strength (Min.) N/mm <sup>2</sup>	Elongation (Min.) %	Impact Energy (-30°C) (Min.) J	Pre-heating and Post Weld Heat Treatment Intertemp. Temperature (°C)	Post Weld Heat Treatment Temperature (°C)	Ductility (minitest)	
	W/G	Cr	Mo	1 Si													
Mn	0.05-0.15	0.05-0.25	0.60-1.20	0.025	0.025	-	0.45-0.55	-	-	-	305	510	22	47	<200	None	-
MnSi	0.08-0.15	0.05-0.60	0.70-1.30	0.02	0.02	-	0.40-0.60	-	-	-	305	510	22	47	<200	None	-
MnMo	0.08-0.15	0.05-0.25	1.30-1.70	0.025	0.025	-	0.45-0.55	-	-	-	395	510	18	47	200-300	650-750	60
MnV	0.08-0.15	0.10-0.20	0.60-1.00	0.02	0.02	0.30-0.50	0.50-1.00	0.25-0.45	-	-	395	510	18	47	200-300	650-750	60
MnVSi	0.08-0.15	0.40-0.70	0.70-1.10	0.02	0.02	0.30-0.50	0.50-1.00	0.25-0.40	-	-	355	510	20	47	150-250	650-750	60
CrMoSi	0.08-0.15	0.05-0.60	0.60-1.20	0.02	0.02	0.90-1.30	0.40-0.55	-	-	-	435	590	15	24	200-300	680-750	60
CrMoV	0.08-0.15	0.05-0.25	0.60-1.20	0.02	0.02	0.90-1.30	0.90-1.30	0.10-0.35	-	-	430	590	18	47	200-300	650-750	60
CrMoVSi	0.08-0.15	0.50-0.60	0.60-1.20	0.02	0.02	0.90-1.30	0.90-1.30	0.10-0.35	-	-	430	590	18	47	200-300	650-750	60
CrMo2Si	0.08-0.15	0.05-0.25	0.30-0.70	0.02	0.02	2.20-2.80	0.90-1.15	-	-	-	430	590	18	47	200-300	650-750	60
CrMo2Mo2	0.11	0.15	0.60-1.20	0.02	0.02	2.30-3.00	0.90-1.20	-	-	-	430	590	18	47	200-300	650-750	60
CrMo2Mo2Si	0.05	0.05-0.25	0.30-0.70	0.02	0.02	2.70-2.90	0.90-1.15	-	-	-	430	590	18	47	200-300	650-750	60
CrMo2Si	0.05	0.05-0.60	0.60-1.20	0.02	0.02	2.30-3.00	0.90-1.20	-	-	-	430	590	17	47	200-300	750-760	60
CrMo2Si	0.05-0.10	0.30-0.60	0.30-0.75	0.02	0.02	5.50-6.50	0.50-0.80	-	-	-	438	590	16	34	200-300	740-790	120
CrMo2Si	0.05-0.10	0.30-0.60	0.30-0.70	0.025	0.025	8.50-10.0	0.90-1.20	0.15	Ni 1.0	-	438	590	16	34	200-300	740-790	120
CrMo2Si	0.05-0.10	0.40-0.60	0.40-0.60	0.02	0.02	8.50-10.0	0.90-1.20	-	-	-	415	565	17	47	250-350	750-760	100
CrMo2Si	0.05-0.15	0.0	0.40-1.50	0.02	0.02	0.0-10.5	0.90-1.20	0.15-0.30	Ni 0.4-1.2 Nb 0.025-0.25	-	415	565	17	47	250-350	750-760	100
CrMoVW12	0.22-0.30	0.05-0.40	0.40-1.20	0.025	0.02	10.5-12.5	0.80-1.20	0.20-0.40	Ni 0.8-1.0 Cr 0.35-0.60	-	560	690	15	34	250-350 <sup>high</sup>	740-760	120
CrMoVW12Si	0.17-0.24	0.20-0.60	0.40-1.00	0.025	0.02	10.5-12.0	0.80-1.20	0.20-0.40	Ni 0.8-1.0 Cr 0.35-0.60	-	560	690	15	34	250-350 <sup>high</sup>	740-760	120
Z									Any other agreed composition								

1) Unless noted otherwise, Ni<0.3 Cu<0.3 V<0.03 Nb<0.01 Cr<0.2

2) Better if Mn/Si>2

a) Test specimen should be cooled to 300C in an oven not faster than 200 C/hour

b) The test specimen should be cooled to 120-100C right after the welding and it should stay at that temperature at least an hour

## Table of Low-Alloy Steel Electrodes and Rods according to AWS A5.28

ER 90S - B5

Chemical Composition for Solid Electrodes and Wires													
Symbol	C	Mn	Si	P	S	Ni	Cr	Mo	V	Ti	Zr	Al	Cu/Other
<b>Carbon-Molybdenum Steel Electrodes and Rods</b>													
ER70S-A1	0.12	1.30	0.30-0.7	0.021	0.025	0.20	0.4-0.65	-	-	-	-	-	0.35, 0.50
<b>Chromium-Molybdenum Steel Electrodes and Rods</b>													
ER80S-B2	0.07-0.12	0.4-0.7	0.4-0.7	0.023	0.025	0.20	1.2-1.0	0.40-0.65	-	-	-	-	0.35, 0.50
ER70S-B2L	0.05	0.4-0.7	0.4-0.7	0.023	0.025	0.20	1.2-1.5	0.40-0.65	-	-	-	-	0.35, 0.50
ER80S-B3	0.07-0.12	0.4-0.7	0.4-0.7	0.023	0.025	0.20	2.3-2.7	0.9-1.2	-	-	-	-	0.35, 0.50
ER80S-B3L	0.05	0.4-0.7	0.4-0.7	0.023	0.025	0.20	2.3-2.7	0.9-1.2	-	-	-	-	0.35, 0.50
ER80S-B6	0.10	0.4-0.7	0.50	0.023	0.025	0.50	4.5-6.0	0.45-0.65	-	-	-	-	0.35, 0.50
ER80S-B8	0.10	0.4-0.7	0.50	0.023	0.025	0.50	8.0-10.5	0.8-1.2	-	-	-	-	0.35, 0.50
ER90S-B9	0.07-0.13	1.25	0.15-0.30	0.010	0.010	1.00	8.0-9.6	0.8-1.1	0.15-0.25	-	-	0.04, 0.20	0.50
<b>Nickel Steel Electrodes and Rods</b>													
ER80S-NH-1	0.12	1.25	0.40-0.60	0.023	0.025	0.35-1.1	0.15	0.35	0.05	-	-	-	0.35, 0.50
ER90S-NI-2	0.12	1.20	0.40-0.60	0.023	0.025	2.00-2.75	-	-	-	-	-	-	0.35, 0.50
ER80S-NI-3	0.12	1.25	0.40-0.60	0.023	0.025	3.00-3.75	-	-	-	-	-	-	0.35, 0.50
<b>Manganese-Molybdenum Steel Electrodes and Rods</b>													
ER80S-D2	0.07-0.12	1.6-2.1	0.5-0.5	0.023	0.025	0.15	-	0.4-0.6	-	-	-	-	0.5, 0.5
ER90S-D2	-	-	-	-	-	-	-	-	-	-	-	-	-
<b>Other Low-Alloy Steel Electrodes and Rods</b>													
ER100S-1	0.05	1.25-1.8	0.20-0.55	0.010	0.010	1.4-2.1	0.30	0.25-0.50	0.05	0.10	0.10	0.10	0.25, 0.50
ER100S-1	0.05	1.4-1.8	0.20-0.55	0.010	0.010	1.9-2.6	0.50	0.25-0.50	0.04	0.10	0.10	0.10	0.25, 0.50
ER120S-1	0.10	1.4-1.8	0.25-0.50	0.010	0.010	2.0-2.8	0.30	0.30-0.55	0.03	0.10	0.10	0.10	0.25, 0.50
ER90S-G	-	-	-	-	-	-	-	-	-	-	-	-	-

Not Specified

Chemical Composition for Composite Electrode Weld Metal													
Symbol	C	Mn	Si	P	S	Ni	Cr	Mo	V	Ti	Zr	Al	Cu/Other
<b>Manganese-Molybdenum Weld Metal</b>													
E90C-D2	0.12	1.0-1.9	0.90	0.025	0.030	-	-	0.4-0.6	-	-	-	-	0.35, 0.50
<b>Chromium-Molybdenum Weld Metal</b>													
E70C-B2L	0.05	0.4-1.0	0.25-0.60	0.025	0.030	0.20	1.0-1.9	0.40-0.65	-	-	-	-	0.35, 0.50
E80C-B2	0.05-0.12	0.4-1.0	0.25-0.60	0.023	0.030	0.20	1.0-1.0	0.40-0.65	-	-	-	-	0.35, 0.50
E80C-B3L	0.05	0.4-1.0	0.25-0.50	0.023	0.030	0.20	2.0-2.8	0.90-1.20	-	-	-	-	0.35, 0.50
E90C-B3	0.05-0.12	0.4-1.0	0.25-0.50	0.023	0.030	0.20	2.0-2.5	0.90-1.20	-	-	-	-	0.35, 0.50
<b>Nickel Weld Metal</b>													
E80C-NI-1	0.12	1.50	0.90	0.025	0.030	0.6-1.1	-	0.30	-	-	-	-	0.35, 0.50
E70C-NI2	0.05	1.45	0.90	0.025	0.030	1.75-2.75	-	-	-	-	-	-	0.35, 0.50
E80C-NI2	0.12	1.50	0.90	0.025	0.030	1.75-2.75	-	-	-	-	-	-	0.35, 0.50
E80C-NI3	0.12	1.80	0.90	0.025	0.030	2.75-3.75	-	-	-	-	-	-	0.35, 0.50
<b>Other Low-Alloy Weld Metal</b>													
E90C-G	-	-	-	-	-	-	-	-	-	-	-	-	-

Not Specified

Symbol	Shielding Gas	Mechanical Values					Impact Energy (J) Min.
		Tensile Strength (N/mm <sup>2</sup> ) Min.	Yield Strength (N/mm <sup>2</sup> ) Min.	Elongation	Heat Treatment		
					PWHT (°C)	Interpass Temperature (°C)	
ER70S-B2L	Argon/1-5%O <sub>2</sub>	515	400	19	620±10	135 - 105	Not Required
ER70C-B2L							
ER70S-A1							Not Required
ER80S-B2		560	470	19			Not Required
ER90C-B2							Not Required
ER80S-B3L		560	470	17	650±15	185 - 215	Not Required
ER90S-B3		620	540	17			
ER80S-B6		560	470	17	745±15	177 - 232	Not Required
ER80S-B8					745±15	205 - 260	Not Required
ER90S-B9					745±15	150 - 260	Not Required
E70C-N1-2	Argon/5%O <sub>2</sub>	480	400	24	620±15	135 - 165	
ER100S-N1		550	470	24	-	135 - 165	-82 °C 27 J
ER80C-NH1					-	135 - 165	-48 °C 27 J
ER80S-NH2	Argon/1-5%O <sub>2</sub>				620±15	135 - 165	-62 °C 27 J
ER80C-NH2		560	470	24	620±15	135 - 165	-62 °C 27 J
ER90S-NH3					620±15	135 - 165	-73 °C 27 J
ER80C-NH3					620±15	135 - 165	-73 °C 27 J
ER80S-D2	CO <sub>2</sub>	560	470	17	-	135 - 165	-29 °C 27 J
ER90S-D2	Argon/1-5%O <sub>2</sub>	620	540	17	-	135 - 165	-29 °C 27 J
ER90C-D2		690	610	16	-	135 - 165	-51 °C 68 J
ER110S-1		760	660	16	-	135 - 165	-61 °C 68 J
ER120S-1	Argon/2%O <sub>2</sub>	830	730	14	-	135 - 165	-51 °C 68 J
ER70S-G	Not Specified (Specified according to the producer and the customer)	460	Not Specified (Specified according to the producer and the customer)	Not Specified (Specified according to the producer and the customer)	Not Specified (Specified according to the producer and the customer)	Not Specified (Specified according to the producer and the customer)	Not Specified (Specified according to the producer and the customer)
E70C-G							
ER80S-G		550					
ER90C-G		620					
ER100S-G		690					
E100C-G		760					
ER110S-G		760					
ER120S-G		830					
E120C-G							



# Table of Wire Electrodes of Arc Welding of Stainless and Heat-Resisting Steels According to TS EN ISO 14343-A



GeKa

G 19 12 3 Nb

Alloy Symbol	Chemical Composition % [1]2										Other Elements		Mechanical Properties			Production Product (S) TIG Rods (W) TIG Wire (S) Shielding Gas (P) Plasma
	C	Mn	Si	Mb	pH	g <sup>3</sup>	Cr	Ni	Mo	Nb	Tensile Strength (N/mm <sup>2</sup> ) Min./Max.	Yield Strength (N/mm <sup>2</sup> ) Min./Max.	Borgon (% Min.)	Post Weld Heat Treatment		
<b>Martensitic / Ferritic</b>																
13 L	0.18	1.0	0.02	0.05	0.02	12.5-14.6			0.1		350	455	15	840-970 C for 2h	(S) TIG Rods	
13 L 1	0.05	1.0	0.05	0.05	0.02	12.6-14.6			0.1		350	440	15	840-970 C for 2h	(W) TIG Wire	
12 L	0.05	1.0	0.05	0.05	0.02	11.5-14.4	0.05-0.2		0.1-1.0		350	430	15	500-200 C for 2h	(S) Shielding Gas	
17	0.13	1.0	0.05	0.05	0.02	16.5-18.5					350	450	15	700-750 C for 2h	(P) Plasma	
<b>Austenitic</b>																
19 L	0.02	0.65	1.0-2.5	0.03	0.02	19.5-21.6	9.0-11.0		0.1		320	510	30	Nb20		
19 L Ni	0.04	0.68	1.0-2.5	0.03	0.02	19.5-21.6	9.0-11.0		0.1		350	550	30	Nb20		
18 L 3 L	0.01	0.45	1.0-2.5	0.03	0.02	19.5-21.6	11.0-14.0	1.1-1.0			320	510	25	Nb20		
18 L 3 L Nb	0.04	0.45	1.0-2.5	0.03	0.02	19.5-21.6	11.0-14.0	1.1-1.0			350	550	25	Nb20		
<b>High corrosion resistance</b>																
21 L 0 L	0.03	1.0	2.5	0.05	0.02	21.0-24.6	7.0-10.0	1.5-4.0			450	550	20	Nb20		
21 L 2 L	0.03	1.0	2.5	0.05	0.02	24.0-27.0	6.0-8.0	1.5-2.0			500	700	15	Nb20		
21 L 3 L	0.03	1.0	2.5	0.05	0.02	24.0-27.0	9.0-11.0	1.5-2.0			500	620	16	Nb20		
21 L 4 L	0.04	1.0-2.5	0.05	0.05	0.02	24.0-27.0	9.0-10.8	1.5-1.6			500	620	16	Nb20		
<b>High strength</b>																
18 L 3 L	0.03	1.0	1.0-3.0	0.05	0.02	17.0-20.0	10.0-14.0	1.5-4.0			300	480	25	Nb20		
18 L 3 L Ni	0.03	1.0	1.0-3.0	0.05	0.02	17.0-20.0	10.0-14.0	1.5-1.6			300	480	25	Nb20		
18 L 3 L Ni 1	0.03	1.0	1.0-3.0	0.05	0.02	17.0-20.0	10.0-14.0	1.5-1.6			350	550	25	Nb20		
24 L 5 Cu L	0.03	1.0	1.0-3.0	0.05	0.02	19.0-20.0	24.0-27.0	4.0-6.0			350	510	25	Nb20		
24 L 3 3 Nb L	0.03	1.0	1.0-3.0	0.05	0.02	19.0-20.0	10.0-13.0	1.5-1.5			320	510	25	Nb20		
24 L 2 2 Ni L	0.03	1.0	1.0-3.0	0.05	0.02	24.0-27.0	21.0-24.0	1.5-3.0			320	510	25	Nb20		
27 L 3 L Cu L	0.03	1.0	1.0-3.0	0.05	0.02	26.0-28.0	30.0-32.0	3.0-4.0			360	600	25	Nb20		
<b>Special Types</b>																
14 B Ni	0.04	1.2	5.0-8.0	0.03	0.02	17.0-20.0	7.0-10.0	0.5			300	500	35	Nb20		
20 L 3 L	0.12	1.0	1.0-2.5	0.03	0.02	16.0-21.0	6.0-10.0	1.5-3.0			400	620	20	Nb20		
21 L 2 L	0.03	0.85	1.0-2.5	0.03	0.02	22.0-25.0	11.0-14.0	0.3			350	510	25	Nb20		
22 L 2 Ni	0.04	1.0	1.0-2.5	0.03	0.02	22.0-25.0	11.0-14.0	0.3			350	550	25	Nb20		
22 L 2 L	0.03	1.0	1.0-2.5	0.03	0.02	22.0-25.0	11.0-14.0	0.3			350	550	25	Nb20		
22 L 2 L 2	0.03	1.0	1.0-2.5	0.03	0.02	22.0-25.0	11.0-14.0	1.5-2.0			350	550	25	Nb20		
26 L 9	0.18	1.0	1.0-2.5	0.03	0.02	28.0-32.0	8.0-12.0	0.5			400	600	15	Nb20		
<b>Heat-Resisting Types</b>																
16 B 2	0.16	1.0	1.0-2.5	0.03	0.02	14.5-16.5	7.0-9.5	1.5-2.5			320	510	25	Nb20		
19 B 1	0.04-0.05	1.0	1.0-2.5	0.03	0.02	16.0-21.0	8.0-11.0	0.3			350	550	30	Nb20		
19 L 2 3 H	0.04-0.05	1.0	1.0-2.5	0.03	0.02	16.0-21.0	11.0-14.0	1.5-3.0			350	550	25	Nb20		
22 L 2 H	0.06-0.15	2.0	1.0-2.5	0.03	0.02	21.0-24.0	11.0-14.0	0.3			350	550	25	Nb20		
24 L	0.14	2.0	1.0-2.5	0.03	0.02	24.0-27.0	4.0-5.0	0.3			400	600	20	Nb20		
24 L 2 H	0.06-0.15	2.0	1.0-2.5	0.03	0.02	24.0-27.0	10.0-12.0	0.3			350	550	25	Nb20		
24 L 2 Nb	0.06-0.15	2.0	1.0-2.5	0.03	0.02	24.0-27.0	10.0-12.0	0.3			350	550	25	Nb20		
24 L 2 Nb 1	0.06-0.15	2.0	1.0-2.5	0.03	0.02	24.0-27.0	10.0-12.0	0.3			350	550	25	Nb20		
24 L 2 Nb 2	0.06-0.15	2.0	1.0-2.5	0.03	0.02	24.0-27.0	10.0-12.0	0.3			350	550	25	Nb20		
24 L 2 Nb 3	0.06-0.15	2.0	1.0-2.5	0.03	0.02	24.0-27.0	10.0-12.0	0.3			350	550	25	Nb20		
24 L 2 Nb 4	0.06-0.15	2.0	1.0-2.5	0.03	0.02	24.0-27.0	10.0-12.0	0.3			350	550	25	Nb20		
24 L 2 Nb 5	0.06-0.15	2.0	1.0-2.5	0.03	0.02	24.0-27.0	10.0-12.0	0.3			350	550	25	Nb20		
16 B 2 2	0.14-0.25	0.6-2.0	1.0-2.5	0.03	0.02	16.0-21.0	23.0-27.0	0.2			350	550	10	Nb20		

1) Single values shown in the table mean maximum values.  
2) 2% Nb shall be added to the alloy grades in case S-0816 - S-13

3) Diameter length in mm 150 for types the rest specifications diameter

## Table of Wire Electrodes for Arc Welding of Stainless Steels According to AWS A5.9

ER	316L Si
----	---------

ER: Wire electrodes

Chemical Composition (%)							Mechanical Values			
Symbol	C	Cr	Ni	Mo	Mn	Si	Other Elements	Tensile Strength (MPa)	Elongation (%)	Heat Treatment °C
ER209	0,05	20,5-24,0	9,5-12,0	1,5-3,0	4,0-7,0	0,90	N:0,10-0,30 Cu:0,75	590	15	None
ER218	0,10	10,0-18,0	8,0-9,0	0,75	7,0-9,0	3,5-4,5	N:0,08-0,18 Cu:0,75	-	-	-
ER219	0,05	10,0-21,5	6,5-7,0	0,75	8,0-10,0	1,00	N:0,10-0,30 Cu:0,75	620	16	None
ER240	0,05	17,0-19,0	4,0-6,0	0,75	10,5-13,5	1,00	N:0,10-0,30 Cu:0,75	590	15	None
ER307	0,04-0,34	18,5-22,0	8,0-10,7	0,5-1,5	3,3-4,75	0,30-0,65	Cu:0,75	590	30	None
ER308	0,08	19,5-22,0	9,0-11,0	0,75	1,0-2,8	0,30-0,65	Cu:0,75	590	35	None
ER308H	0,04-0,08	19,5-22,0	9,0-11,0	0,50	1,0-2,8	0,30-0,65	Cu:0,75	550	35	None
ER308L	0,03	19,5-22,0	9,0-11,0	0,75	1,0-2,8	0,30-0,65	Cu:0,75	570	35	None
ER308Mo	0,08	18,0-21,0	9,0-12,0	2,0-3,0	1,0-2,8	0,30-0,65	Cu:0,75	590	35	None
ER308LMo	0,04	18,0-21,0	9,0-12,0	2,0-3,0	1,0-2,8	0,30-0,65	Cu:0,75	520	35	None
ER308Si	0,08	19,5-22,0	9,0-11,0	0,75	1,0-2,8	0,65-1,00	Cu:0,75	-	-	-
ER308Si	0,03	19,5-22,0	9,0-11,0	0,75	1,0-2,8	0,65-1,00	Cu:0,75	-	-	-
ER309	0,12	23,0-25,0	12,0-14,0	0,75	1,0-2,8	0,30-0,65	Cu:0,75	550	30	None
ER309L	0,03	23,0-25,0	12,0-14,0	0,75	1,0-2,8	0,30-0,65	Cu:0,75	520	30	None
ER309Mo	0,12	23,0-25,0	12,0-14,0	3,0-3,0	1,0-2,8	0,30-0,65	Cu:0,75	550	30	None
ER309LMo	0,03	23,0-25,0	12,0-14,0	3,0-3,0	1,0-2,8	0,30-0,65	Cu:0,75	520	30	None
ER309Si	0,12	23,0-25,0	12,0-14,0	0,75	1,0-2,8	0,65-1,00	Cu:0,75	-	-	-
ER309Si	0,03	23,0-25,0	12,0-14,0	0,75	1,0-2,8	0,65-1,00	Cu:0,75	-	-	-
ER310	0,08-0,15	25,0-28,0	20,0-22,5	0,75	1,0-2,8	0,30-0,65	Cu:0,75	550	30	None
ER312	0,15	28,0-32,0	20,0-20,5	0,75	1,0-2,8	0,30-0,65	Cu:0,75	560	22	None
ER316	0,08	18,0-20,0	11,0-14,0	2,0-3,0	1,0-2,8	0,30-0,65	Cu:0,75	520	30	None
ER316H	0,04-0,08	18,0-20,0	11,0-14,0	2,0-3,0	1,0-2,8	0,30-0,65	Cu:0,75	520	30	None
ER316L	0,03	18,0-20,0	11,0-14,0	2,0-3,0	1,0-2,8	0,30-0,65	Cu:0,75	490	30	None
ER316Si	0,08	18,0-20,0	11,0-14,0	2,0-3,0	1,0-2,8	0,65-1,00	Cu:0,75	-	-	-
ER316Si	0,03	18,0-20,0	11,0-14,0	2,0-3,0	1,0-2,8	0,65-1,00	Cu:0,75	-	-	-
ER317	0,08	18,5-20,5	13,0-15,0	2,0-3,0	1,0-2,8	0,30-0,65	Cu:0,75	550	30	None
ER317L	0,03	18,5-20,5	13,0-15,0	2,0-3,0	1,0-2,8	0,30-0,65	Cu:0,75	520	30	None
ER318	0,08	19,0-20,0	11,0-14,0	2,0-3,0	1,0-2,8	0,30-0,65	Cb:0,02-0,10 max Cu:0,75	550	25	None
ER320	0,07	19,0-21,0	32,0-36,0	2,0-3,0	2,80	0,60	Cb:0,02-0,10 max Cu:3,0-4,0	550	30	None
ER320R	0,025	19,0-21,0	32,0-36,0	2,0-3,0	1,9-2,5	0,15	Cb:0,02-0,10 max Cu:3,0-4,0	520	30	None
ER321	0,08	18,5-20,5	9,0-10,5	0,75	1,0-2,8	0,30-0,65	Ti:0,02-0,10 max Cu:0,75	-	-	-
ER330	0,18-0,25	15,0-17,0	34,0-37,0	0,75	1,3-2,5	0,30-0,65	Cu:0,75	520	25	None
ER347	0,08	19,0-21,5	9,0-11,0	0,75	1,9-2,5	0,50-0,65	Cb:0,02-0,10 max Cu:0,75	520	30	None
ER347Si	0,08	19,0-21,5	9,0-11,0	0,75	1,9-2,5	0,65-1,00	Cb:0,02-0,10 max Cu:0,75	-	-	-
ER350	0,025	20,5-28,5	30,0-33,0	3,2-4,2	1,9-2,5	0,50	Cu:0,75-1,50	520	30	None
ER355	0,025	19,5-21,5	24,0-26,0	4,3-5,2	1,9-2,5	0,50	Cu:1,20-2,00	520	30	None
ER409	0,08	10,5-13,5	0,80	0,50	0,50	0,50	Ti:0,02-0,10 max Cu:0,75	-	-	-
ER409Cb	0,06	10,5-13,5	0,80	0,50	0,50	1,20	Cb:0,02-0,10 max Cu:0,75	-	-	-
ER410	0,12	11,5-13,5	0,80	0,75	0,80	0,50	Cu:0,75	450	20	730-780
ER410NbMo	0,06	11,0-12,5	4,0-5,0	0,4-0,7	0,60	0,50	Cu:0,75	760	15	625-630
ER420	0,25-0,40	12,0-14,0	0,80	0,75	0,60	0,50	Cu:0,75	-	-	-
ER430	0,10	15,5-17,0	0,80	0,75	0,60	0,50	Cu:0,75	450	20	760-780
ER446LMo	0,015	25,0-27,5	a	0,75-1,50	0,40	0,40	N:0,015	-	-	-
ER502	0,10	4,8-6,0	0,60	0,45-0,65	0,60	0,50	Cu:0,75	620	20	840-870
ER525	0,10	8,0-10,0	0,50	0,8-1,2	0,50	0,50	Cu:0,75	620	20	840-870
ER630	0,05	16,0-16,75	4,5-5,0	0,75	0,25-0,75	0,75	Cb:0,15-0,35 Cu:3,25-4,00	450	7	1025-1050
ER610-16H	0,04-0,08	18,5-20,0	9,0-11,0	0,25	1,0-2,0	0,30-0,65	Ti:0,02-0,10 max Cu:0,75	-	-	-
ER16-S-2	0,10	14,5-16,5	7,5-9,5	1,0-2,0	1,0-2,0	0,30-0,65	Cu:0,75	550	35	None
ER2309	0,03	21,5-23,5	7,5-8,5	0,50-0,70	0,50-0,70	0,90	N:0,08-0,20 Cu:0,75	990	20	None
ER2353	0,04	24,0-27,0	4,5-6,5	1,50	1,50	1,00	N:0,10-0,25 Cu:1,5-2,5	760	15	None
ER356	0,05-0,15	21,0-23,0	19,0-22,0	0,50-2,00	0,50-2,0	0,20-0,80	Cb:0,16-0,21,0	-	-	-

a) Nickel+Copper total is max. %0,5

## Table of Covered Electrodes for Manual Metal Arc Welding of Nickel and Nickel Alloys According to TS EN ISO 14172

E – Ni 6825 (NiCr22Mo9Nb)

Symbol	Production Form
E	Covered Electrodes
S	Wires or Rods
T	Flux coated Wires or Flux coated Rods
R	Cast Iron Welding Fluxes
B	Stick
C	Sintered rods, wires or flux-coated-sticks
P	Metal Powder

Alloy Symbol		Chemical Composition (% a)											Mechanical Values of Electrode in the A Zone						
Numerical	Chemical	C	Mn	Fe	Si	Cu	Ni	Co	Al	Ti	Cr	Nb	Mo	V	W	Notes	Yield Strength N/mm <sup>2</sup>	Ultimate Tensile Strength N/mm <sup>2</sup>	
Ni 6821	Ni63	0.10	0.7	0.7	1.2	0.2	6.2	-	1.0	1.0-4.0	-	-	-	-	-	-	200	470	18
<b>Nickel-Copper</b>																			
Ni 6821	NiCu50	0.15	4.0	2.5	1.5	27.0-34.0	min. 62.0	-	1.0	1.0	-	-	-	-	-	-	200	480	27
Ni 6821	NiCu50Min3Ti	0.15	4.0	2.5	1.3	28.0-31.0	min. 63.0	-	1.0	1.5	-	3.0	-	-	-	-	200	480	27
<b>Nickel-Chromium</b>																			
Ni 6822	NiCr20Mo9Nb	0.10	2.0-6.0	4.0	0.8	0.5	min. 63.0	-	-	0.5	18.0-22.0	1.8-3.0	2.0	-	-	-	360	600	22
Ni 8231	NiCr22Mo9Nb	0.18-0.10	0.3-1.0	3.0	0.3-1.7	0.5	min. 45.0	5.0	0.1	-	20.0-24.0	-	1.0-2.0	-	-	-	350	620	18
<b>Nickel-Chromium-Iron</b>																			
Ni 6825	NiCr25Fe10Nb	0.05-0.25	0.5	3.0-11.0	0.8	-	min. 55.0	-	1.2-2.2	0.3	24.0-26.0	-	-	-	-	-	400	660	12
Ni 6825	NiCr15Fe8Nb	0.08	3.5	11.0	0.8	0.5	min. 62.0	-	-	-	13.0-17.0	0.5-1.0	-	-	-	-	300	550	27
Ni 6826	NiCr18Fe12NbMo	0.10	1.0-3.5	12.0	0.8	0.5	min. 62.0	-	-	-	13.0-17.0	0.5-3.0	0.5-2.5	-	-	-	300	550	27
Ni 6826	NiCr18Fe12NbMo	0.20	1.0-5.0	12.0	1.0	0.5	min. 60.0	-	-	-	13.0-17.0	1.0-3.5	1.5-3.5	-	-	-	360	650	18
Ni 6826	NiCr14Fe18NbMo	0.15	1.0-4.5	12.0	0.8	0.5	min. 50.0	-	-	-	12.0-17.0	0.5-3.0	2.5-5.5	-	1.5	-	360	650	18
Ni 6826	NiCr15Fe16NbMoW	0.20	1.0-3.5	12.0	0.8	0.5	min. 50.0	-	-	-	13.0-17.0	1.0-3.0	1.5-5.5	-	1.5-3.5	-	360	650	18
Ni 6152	NiCr18Fe8Nb	0.05	5.0	7.0-12.0	0.8	0.5	min. 50.0	-	0.5	0.5	23.0-21.5	1.0-2.0	0.1	-	-	-	360	550	27
Ni 6152	NiCr18Fe8Nb	0.10	5.0-10.0	1.0	0.5	min. 60.0	-	1.0	13.0-17.0	-	1.8-3.5	-	0.3 max. 0.3 max. 0.3 max.	0.1	-	-	360	550	27
<b>Nickel-25%Ni-15%Mo</b>																			
Ni 6833	NiCr25Fe15Mo9Nb	0.10	1.5-2.0	min. 16.0	0.8-1.2	0.5	44.0-47.0	2.5-3.5	-	-	24.0-26.0	-	2.5-3.5	-	2.5-3.5	-	300	560	18
<b>Nickel-28%Ni-7%Nb</b>																			
Ni 6701	NiCr28Fe7Nb	0.10	0.5-2.0	7.0	0.8-2.0	-	42.0-48.0	3.0-5.0	-	-	33.0-39.0	0.6-1.8	-	-	-	-	400	650	8
<b>Nickel-28%Ni-10%Nb</b>																			
Ni 6704	NiCr28Fe10Nb	0.10	0.5-2.0	6.0	0.8-2.0	-	47.0-50.0	3.0-5.0	-	-	27.0-30.0	-	-	-	-	-	400	650	8
<b>Nickel-28%Ni-10%Nb-2%W</b>																			
Ni 6704	NiCr28Fe10Nb2W	0.10	0.5-2.0	6.0	0.8	-	min. 55.0	-	1.5-2.8	0.3	26.0-28.0	-	-	-	-	-	400	650	12
<b>Nickel-25%Ni-10%Nb-2%W</b>																			
Ni 6828	NiCr25Fe10Nb2W	0.05	1.0-3.0	30.0	0.7	1.6-3.0	35.0-40.0	0.1	1.0	1.0	27.0-21.0	1.0	2.4-4.5	-	-	-	240	560	22
Ni 6155	NiCr25Fe10Mo6	0.05	1.0-3.0	30.0	0.7	1.5-3.0	37.0-42.0	0.1	1.0	1.0	23.0-27.0	1.0	3.5-7.5	-	-	-	240	550	22

## Table of Covered Electrodes for Manual Metal Arc Welding of Nickel and Nickel Alloys according to TS EN ISO 14172

Alloy Symbol		Chemical Composition % a)											Notes		Mechanical Values d)				
Numerical	Chemical	C	Mn	Fe	Si	Cu	Ni	Co	Al	Ti	Cr	Nb	Mo	V	W	Notes	Strength N/mm <sup>2</sup>	Elongation 1/2mm <sup>g</sup> %	
<b>Nickel-Molybdenum</b>																			
Ni 1001	NiMo38Fe5	0,07	1,0	4,0-7,0	1,0	0,5	min. 55,0	2,5	-	-	1,0	-	20,0-30,0	0,8	1,0	-	400	650	22
Ni 1004	NiMo5CrFe5	0,12	1,0	4,0-7,0	1,0	0,5	min. 60,0	-	-	-	2,0-5,0	-	21,0-27,0	0,8	1,0	-	400	650	22
Ni 1008	NiMo19W3	0,10	1,5	10,0	0,8	0,5	min. 60,0	-	-	-	0,5-3,5	-	17,0-20,0	-	2,0-4,0	-	360	650	22
Ni 1009	NiMo10W1Cu	0,10	1,5	7,0	0,8	1,1,3	min. 62,0	-	-	-	-	-	18,0-22,0	-	2,0-4,0	-	360	650	22
Ni 1002	NiMo4Cr8Fe5	0,02	1,0	4,0-7,0	0,7	-	min. 60,0	-	-	-	0,0-0,6	-	21,0-30,0	-	-	-	360	500	16
Ni 1005	NiMo28	0,02	2,0	2,0	0,2	0,5	min. 84,5	-	-	-	1,0	-	26,0-30,0	-	1,0	-	400	600	22
Ni 1007	NiMo30Cr	0,02	2,0	1,0-3,0	0,2	0,5	min. 62,0	3,0	-	-	1,0-3,0	-	27,0-33,0	-	3,0	-	350	600	22
Ni 1009	NiMo28Fe4Cr	0,02	1,0	2,0-6,0	0,7	-	min. 65,0	1,0	0,5	-	0,5-1,5	-	26,0-30,0	-	-	-	360	500	20
<b>Nickel-Chromium-Molybdenum</b>																			
Ni 0002	NiCr22Fe18Mo	0,02	1,0	0,20-0,6	1,0	0,5	min. 45,0	0,5-2,5	-	-	20,0-23,0	-	9,0-10,0	-	0,2-1,0	-	360	650	16
Ni 0012	NiCr23Mo9	0,03	1,0	3,5	0,7	0,5	min. 58,0	-	0,4	0,4	20,0-23,0	1,5	9,0-10,5	-	-	-	410	650	22
Ni 0022	NiCr21Mo12W3	0,02	1,0	2,0-4,0	0,2	0,5	min. 49,0	2,0	-	-	20,0-22,0	-	12,5-14,5	0,4	2,5-3,5	-	350	600	22
Ni 0024	NiCr20Mo14	0,02	0,5	1,5	0,2	0,5	min. 55,0	-	-	-	25,0-27,0	-	13,5-15,0	-	-	-	360	600	22
Ni 0003	NiCr20Mo14W3	0,03	1,5	0,0-0,10	1,0	1,0-2,4	min. 56,0	0,0	-	-	26,0-31,5	0,3-1,9	8,0-9,0	-	1,5-4,0	-	350	565	22
Ni 0005	NiCr23Mo15	0,02	1,0	1,5	0,2	-	min. 56,0	-	-	-	20,0-24,0	-	22,0-24,0	-	-	-	360	600	22
Ni 0006	NiCr23Mo16Cu2	0,02	1,0	3,0	0,2	1,3-1,8	min. 45,0	2,0	-	-	20,0-24,0	-	15,0-17,0	-	-	-	400	650	22
Ni 0005	NiCr25Mo16	0,02	0,5	0,9	0,2	0,2	min. 50,0	-	0,4	-	22,0-27,0	-	13,5-16,5	-	-	-	400	650	22
Ni 0270	NiCr26Mo16W	0,02	1,0	4,0-7,0	1,0	0,5	min. 50,0	2,5	-	-	14,5-16,5	-	15,0-16,0	0,4	3,0-4,5	-	400	650	22
Ni 0275	NiCr26Mo16W	0,02	1,0	4,0-7,0	0,2	0,5	min. 50,0	2,5	-	-	14,5-16,5	-	15,0-17,0	0,4	3,0-4,5	-	360	600	22
Ni 0462	NiCr19Mo15	0,028	2,0	1,5	0,4	0,5	min. 56,0	-	-	-	11,0-20,0	0,4	14,0-16,0	0,4	-	-	300	600	22
Ni 0465	NiCr19Mo15Ti	0,02	1,5	3,0	0,2	0,5	min. 56,0	2,0	-	0,7	11,0-13,0	-	14,0-17,0	-	0,5	-	300	600	22
Ni 0520	NiCr14Mo7Fe	0,10	2,0	2,0-4,0	1,0	0,5	min. 55,0	-	-	-	12,0-17,0	0,5-2,0	9,0-9,0	-	1,0-2,0	-	350	620	32
Ni 0520	NiCr22Mo18Fe	0,10	2,0	7,0	0,8	0,5	min. 55,0	-	-	-	20,0-23,0	0,0-0,2	8,0-10,0	-	-	-	420	760	27
Ni 0527	NiCr21Mo16Fe	0,03	2,2	5,0	0,7	0,5	min. 57,0	-	-	-	20,5-22,5	1,0-2,8	8,5-10,0	-	0,5	-	400	650	32
Ni 0500	NiCr26Fe18Mo16W	0,03	0,7	12,0-18,0	0,6	0,5	min. 44,0	1,0	0,5	-	19,0-22,0	0,3	10,0-13,0	-	1,0-2,0	0,19N 0,02S	420	660	30
Ni 0506	NiCr21Mo16W4	0,02	1,0	5,0	0,3	0,5	min. 49,0	-	-	0,3	19,0-23,0	-	15,0-17,0	-	3,0-4,0	-	360	650	27
Ni 0505	NiCr22Mo17Fe19	0,02	1,0	16,0-21,0	1,0	1,5-2,5	min. 45,0	5,0	-	-	21,0-23,5	1,0	0,0-6,0	-	1,5	-	350	620	22
<b>Nickel-Chromium-Cobalt-Molybdenum</b>																			
Ni0017	NiCr22Co12Mo	0,05-0,15	3,0	5,0	1,0	0,5	min. 45,0	0,0-15,0	1,5	0,6	20,0-20,0	1,0	8,0-10,0	-	-	-	400	620	22

a) Single values for all elements except Ni are maxima.

b) The total of unspecified elements shall not exceed 0,5 %.

c) Phosphorus 0,020 max., sulfur 0,015 max.

d) Mechanical values are min. values.

## Table of Flux-cored Electrodes for Gas-Shielded Arc Welding of Non-alloy and Fine-grain Steels according to TS EN ISO 17632-A

Production/product	Chemical Composition (% 1)										Symbols for hydrogen content of the all-weld metal
	T	46	3	1Ni	B	M	4	H6			
<b>G</b> Wire Electrodes											
<b>O</b> Oxy-acetylene											
<b>E</b> Electric arc welding											
<b>S</b> S. submerged arc welding wires											
<b>T</b> Flux-cored wires											
<b>W</b> TIG rods											
<b>F</b> S. submerged arc welding fluxes											

Alloy Symbol	Mn	Ni	Mo	Cr	V	Nb	Cu
No symbol	2.0	0.5	0.2	0.2	0.08	0.05	0.3
Mn	1.4	0.5	0.3-0.6	0.2	0.08	0.05	0.3
MnMo	>1.4-2.0	0.5	0.3-0.6	0.2	0.08	0.05	0.3
1.1 Ni	1.4	0.6-1.2	0.2	0.2	0.08	0.05	0.3
1.5 Ni	1.6	1.2-1.8	0.2	0.2	0.08	0.05	0.3
2Ni	1.4	1.8-2.6	0.2	0.2	0.08	0.05	0.3
3Ni	1.4	2.6-3.6	0.2	0.2	0.08	0.05	0.3
Ni1Ni1	>1.4-2.0	0.6-1.2	0.2	0.2	0.08	0.05	0.3
1 NiMo	1.4	0.6-1.2	0.3-0.6	0.2	0.08	0.05	0.3
Z	Any other agreed composition						

1) Single values shown in the table mean maximum values.

Symbol	Rel. (N/mm <sup>2</sup> )	Rm (N/mm <sup>2</sup> )	A (%)
35	355	440-570	22
38	380	470-500	20
42	420	500-640	20
46	460	530-680	20
50	500	600-720	18
55	550	610-760	16
62	620	690-800	16
68	680	760-860	17
75	790	850-1050	16
85	890	950-1150	15

Symbol for impact properties of all-weld metal	Symbol	Temperature C
Z	no requirements	
A	e20	
0	0	
2	-20	
3	-50	
4	-40	
5	-60	
6	-50	
7	-70	
8	-80	

Symbol for Type of Electrode Core	Symbol-Characteristics	Types of Weld	Shielding Gas
R	Rolls, slow freezing slag	Single and Multiple pass	Required
P	Rolls, fast freezing slag	Single and Multiple pass	Required
B	Spine	Single and Multiple pass	Required
M	Metal Powder	Single and Multiple pass	Required
V	Rolls or Basic/Control	Single Pass	Not Required
W	Basic/Control, slow freezing slag	Single and Multiple pass	Not Required
Y	Basic/Control, fast freezing slag	Single and Multiple pass	Not Required
Z	Other Types	Single and Multiple pass	Not Required

Shielding Gas	M. Composition
C	CO <sub>2</sub>
N	No gas

Symbols for welding position	Symbols for hydrogen content of the all-weld metal
1 PA; PB; PC; PD; PE; PF; PG	H 5; H 10; H 15
2 PA; PB; PC; PD; PE; PF; PA; PB	H 5; H 10; H 15
5 PA; PB; PG	H 5; H 10; H 15

## Table of Flux-Cored Wires according to AWS A5.20

E 7 1 T - 1 M J H4																																																																																																																																																																																																																																																												
<b>E: Electrode</b>																																																																																																																																																																																																																																																												
<b>0 Flat and Horizontal Position</b> <b>1 All Welding Positions</b>																																																																																																																																																																																																																																																												
<b>T: Flux-cored Wires</b>																																																																																																																																																																																																																																																												
<table border="1" style="width: 100%; border-collapse: collapse;"> <thead> <tr> <th>Symbol</th> <th>Yield Strength, Tensile Strength and Elongation %</th> <th>Symbol for impact properties of all-weld metal</th> </tr> </thead> <tbody> <tr><td>E7XT-1, -1M</td><td>400 480 22</td><td>27J at 18°C</td></tr> <tr><td>E7XT-2, -2M</td><td>— 480 —</td><td>—</td></tr> <tr><td>E7XT-3</td><td>— 480 —</td><td>—</td></tr> <tr><td>E7XT-4</td><td>400 480 22</td><td>—</td></tr> <tr><td>E7XT-5, -5M</td><td>400 480 22</td><td>27J at -29°C</td></tr> <tr><td>E7XT-6</td><td>400 480 22</td><td>27J at -29°C</td></tr> <tr><td>E7XT-7</td><td>400 480 22</td><td>—</td></tr> <tr><td>E7XT-8</td><td>400 480 22</td><td>27J at -29°C</td></tr> <tr><td>E7XT-9, -9M</td><td>400 480 22</td><td>27J at -29°C</td></tr> <tr><td>E7XT-10</td><td>— 480 —</td><td>—</td></tr> <tr><td>E7XT-11</td><td>400 480 20</td><td>—</td></tr> <tr><td>E7XT-12, -12M</td><td>400 480 22</td><td>27J at -29°C</td></tr> <tr><td>E6XT-13</td><td>— 415 —</td><td>—</td></tr> <tr><td>E7XT-13</td><td>— 480 —</td><td>—</td></tr> <tr><td>E6XT-14</td><td>— 480 —</td><td>—</td></tr> <tr><td>E6XT-G</td><td>330 415 22</td><td>—</td></tr> <tr><td>E1XT-G</td><td>400 480 22</td><td>—</td></tr> <tr><td>E6XT-GS</td><td>— 415 —</td><td>—</td></tr> <tr><td>E7XT-GS</td><td>— 480 —</td><td>—</td></tr> </tbody> </table>		Symbol	Yield Strength, Tensile Strength and Elongation %	Symbol for impact properties of all-weld metal	E7XT-1, -1M	400 480 22	27J at 18°C	E7XT-2, -2M	— 480 —	—	E7XT-3	— 480 —	—	E7XT-4	400 480 22	—	E7XT-5, -5M	400 480 22	27J at -29°C	E7XT-6	400 480 22	27J at -29°C	E7XT-7	400 480 22	—	E7XT-8	400 480 22	27J at -29°C	E7XT-9, -9M	400 480 22	27J at -29°C	E7XT-10	— 480 —	—	E7XT-11	400 480 20	—	E7XT-12, -12M	400 480 22	27J at -29°C	E6XT-13	— 415 —	—	E7XT-13	— 480 —	—	E6XT-14	— 480 —	—	E6XT-G	330 415 22	—	E1XT-G	400 480 22	—	E6XT-GS	— 415 —	—	E7XT-GS	— 480 —	—																																																																																																																																																																																															
Symbol	Yield Strength, Tensile Strength and Elongation %	Symbol for impact properties of all-weld metal																																																																																																																																																																																																																																																										
E7XT-1, -1M	400 480 22	27J at 18°C																																																																																																																																																																																																																																																										
E7XT-2, -2M	— 480 —	—																																																																																																																																																																																																																																																										
E7XT-3	— 480 —	—																																																																																																																																																																																																																																																										
E7XT-4	400 480 22	—																																																																																																																																																																																																																																																										
E7XT-5, -5M	400 480 22	27J at -29°C																																																																																																																																																																																																																																																										
E7XT-6	400 480 22	27J at -29°C																																																																																																																																																																																																																																																										
E7XT-7	400 480 22	—																																																																																																																																																																																																																																																										
E7XT-8	400 480 22	27J at -29°C																																																																																																																																																																																																																																																										
E7XT-9, -9M	400 480 22	27J at -29°C																																																																																																																																																																																																																																																										
E7XT-10	— 480 —	—																																																																																																																																																																																																																																																										
E7XT-11	400 480 20	—																																																																																																																																																																																																																																																										
E7XT-12, -12M	400 480 22	27J at -29°C																																																																																																																																																																																																																																																										
E6XT-13	— 415 —	—																																																																																																																																																																																																																																																										
E7XT-13	— 480 —	—																																																																																																																																																																																																																																																										
E6XT-14	— 480 —	—																																																																																																																																																																																																																																																										
E6XT-G	330 415 22	—																																																																																																																																																																																																																																																										
E1XT-G	400 480 22	—																																																																																																																																																																																																																																																										
E6XT-GS	— 415 —	—																																																																																																																																																																																																																																																										
E7XT-GS	— 480 —	—																																																																																																																																																																																																																																																										
<table border="1" style="width: 100%; border-collapse: collapse;"> <thead> <tr> <th>Alloy Symbol</th> <th colspan="11">Chemical Composition %</th> </tr> <tr> <th>Symbol</th> <th>UNS Number</th> <th>C</th> <th>Mn</th> <th>Si</th> <th>S</th> <th>P</th> <th>Cr</th> <th>Ni</th> <th>Mo</th> <th>V</th> <th>Al</th> <th>Cu</th> </tr> </thead> <tbody> <tr><td>E7XT-1</td><td rowspan="2">W07801</td><td rowspan="2">0.18</td><td rowspan="2">1.75</td><td rowspan="2">0.30</td><td rowspan="2">0.03</td><td rowspan="2">0.03</td><td rowspan="2">0.20</td><td rowspan="2">0.50</td><td rowspan="2">0.30</td><td rowspan="2">0.08</td><td rowspan="2">—</td><td rowspan="2">0.35</td></tr> <tr><td>E7XT-1M</td></tr> <tr><td>E7XT-5</td><td rowspan="2">W07805</td><td rowspan="2">0.18</td><td rowspan="2">1.75</td><td rowspan="2">0.30</td><td rowspan="2">0.03</td><td rowspan="2">0.03</td><td rowspan="2">0.20</td><td rowspan="2">0.50</td><td rowspan="2">0.30</td><td rowspan="2">0.08</td><td rowspan="2">—</td><td rowspan="2">0.35</td></tr> <tr><td>E7XT-5M</td></tr> <tr><td>E7XT-9</td><td rowspan="2">W07809</td><td rowspan="2">—</td><td rowspan="2">—</td><td rowspan="2">—</td><td rowspan="2">—</td><td rowspan="2">—</td><td rowspan="2">—</td><td rowspan="2">—</td><td rowspan="2">—</td><td rowspan="2">—</td><td rowspan="2">—</td><td rowspan="2">—</td></tr> <tr><td>E7XT-9M</td></tr> <tr><td>E7XT-4</td><td>W07804</td><td>—</td><td>—</td><td>—</td><td>—</td><td>—</td><td>—</td><td>—</td><td>—</td><td>—</td><td>—</td><td>—</td></tr> <tr><td>E7XT-6</td><td>W07806</td><td>—</td><td>—</td><td>—</td><td>—</td><td>—</td><td>—</td><td>—</td><td>—</td><td>—</td><td>—</td><td>—</td></tr> <tr><td>E7XT-7</td><td>W07807</td><td>(1)</td><td>1.75</td><td>0.30</td><td>0.03</td><td>0.03</td><td>0.20</td><td>0.50</td><td>0.30</td><td>0.08</td><td>1.8</td><td>0.35</td></tr> <tr><td>E7XT-8</td><td>W07808</td><td>—</td><td>—</td><td>—</td><td>—</td><td>—</td><td>—</td><td>—</td><td>—</td><td>—</td><td>—</td><td>—</td></tr> <tr><td>E7XT-11</td><td>W07811</td><td>—</td><td>—</td><td>—</td><td>—</td><td>—</td><td>—</td><td>—</td><td>—</td><td>—</td><td>—</td><td>—</td></tr> <tr><td>E6XT-G</td><td>—</td><td>(1)</td><td>1.75</td><td>0.30</td><td>0.03</td><td>0.03</td><td>0.20</td><td>0.50</td><td>0.30</td><td>0.08</td><td>1.8</td><td>0.35</td></tr> <tr><td>E7XT-12</td><td rowspan="2">W07812</td><td rowspan="2">0.15</td><td rowspan="2">1.50</td><td rowspan="2">0.30</td><td rowspan="2">0.03</td><td rowspan="2">0.03</td><td rowspan="2">0.20</td><td rowspan="2">0.50</td><td rowspan="2">0.30</td><td rowspan="2">0.08</td><td rowspan="2">—</td><td rowspan="2">0.35</td></tr> <tr><td>E7XT-12M</td></tr> <tr><td>E6XT-13</td><td>W08813</td><td>—</td><td>—</td><td>—</td><td>—</td><td>—</td><td>—</td><td>—</td><td>—</td><td>—</td><td>—</td><td>—</td></tr> <tr><td>E7XT-2</td><td rowspan="2">W07802</td><td rowspan="2">—</td><td rowspan="2">—</td><td rowspan="2">—</td><td rowspan="2">—</td><td rowspan="2">—</td><td rowspan="2">—</td><td rowspan="2">—</td><td rowspan="2">—</td><td rowspan="2">—</td><td rowspan="2">—</td><td rowspan="2">—</td></tr> <tr><td>E7XT-2M</td></tr> <tr><td>E7XT-3</td><td>W07813</td><td>—</td><td>—</td><td>—</td><td>—</td><td>—</td><td>—</td><td>—</td><td>—</td><td>—</td><td>—</td><td>—</td></tr> <tr><td>E7XT-10</td><td>W07810</td><td>—</td><td>—</td><td>—</td><td>—</td><td>—</td><td>—</td><td>—</td><td>—</td><td>—</td><td>—</td><td>—</td></tr> <tr><td>E7XT-13</td><td>W07813</td><td>—</td><td>—</td><td>—</td><td>—</td><td>—</td><td>—</td><td>—</td><td>—</td><td>—</td><td>—</td><td>—</td></tr> <tr><td>E7XT-14</td><td>W07814</td><td>—</td><td>—</td><td>—</td><td>—</td><td>—</td><td>—</td><td>—</td><td>—</td><td>—</td><td>—</td><td>—</td></tr> <tr><td>E6XT-GS</td><td>—</td><td>—</td><td>—</td><td>—</td><td>—</td><td>—</td><td>—</td><td>—</td><td>—</td><td>—</td><td>—</td><td>—</td></tr> </tbody> </table>		Alloy Symbol	Chemical Composition %											Symbol	UNS Number	C	Mn	Si	S	P	Cr	Ni	Mo	V	Al	Cu	E7XT-1	W07801	0.18	1.75	0.30	0.03	0.03	0.20	0.50	0.30	0.08	—	0.35	E7XT-1M	E7XT-5	W07805	0.18	1.75	0.30	0.03	0.03	0.20	0.50	0.30	0.08	—	0.35	E7XT-5M	E7XT-9	W07809	—	—	—	—	—	—	—	—	—	—	—	E7XT-9M	E7XT-4	W07804	—	—	—	—	—	—	—	—	—	—	—	E7XT-6	W07806	—	—	—	—	—	—	—	—	—	—	—	E7XT-7	W07807	(1)	1.75	0.30	0.03	0.03	0.20	0.50	0.30	0.08	1.8	0.35	E7XT-8	W07808	—	—	—	—	—	—	—	—	—	—	—	E7XT-11	W07811	—	—	—	—	—	—	—	—	—	—	—	E6XT-G	—	(1)	1.75	0.30	0.03	0.03	0.20	0.50	0.30	0.08	1.8	0.35	E7XT-12	W07812	0.15	1.50	0.30	0.03	0.03	0.20	0.50	0.30	0.08	—	0.35	E7XT-12M	E6XT-13	W08813	—	—	—	—	—	—	—	—	—	—	—	E7XT-2	W07802	—	—	—	—	—	—	—	—	—	—	—	E7XT-2M	E7XT-3	W07813	—	—	—	—	—	—	—	—	—	—	—	E7XT-10	W07810	—	—	—	—	—	—	—	—	—	—	—	E7XT-13	W07813	—	—	—	—	—	—	—	—	—	—	—	E7XT-14	W07814	—	—	—	—	—	—	—	—	—	—	—	E6XT-GS	—	—	—	—	—	—	—	—	—	—	—	—
Alloy Symbol	Chemical Composition %																																																																																																																																																																																																																																																											
Symbol	UNS Number	C	Mn	Si	S	P	Cr	Ni	Mo	V	Al	Cu																																																																																																																																																																																																																																																
E7XT-1	W07801	0.18	1.75	0.30	0.03	0.03	0.20	0.50	0.30	0.08	—	0.35																																																																																																																																																																																																																																																
E7XT-1M																																																																																																																																																																																																																																																												
E7XT-5	W07805	0.18	1.75	0.30	0.03	0.03	0.20	0.50	0.30	0.08	—	0.35																																																																																																																																																																																																																																																
E7XT-5M																																																																																																																																																																																																																																																												
E7XT-9	W07809	—	—	—	—	—	—	—	—	—	—	—																																																																																																																																																																																																																																																
E7XT-9M																																																																																																																																																																																																																																																												
E7XT-4	W07804	—	—	—	—	—	—	—	—	—	—	—																																																																																																																																																																																																																																																
E7XT-6	W07806	—	—	—	—	—	—	—	—	—	—	—																																																																																																																																																																																																																																																
E7XT-7	W07807	(1)	1.75	0.30	0.03	0.03	0.20	0.50	0.30	0.08	1.8	0.35																																																																																																																																																																																																																																																
E7XT-8	W07808	—	—	—	—	—	—	—	—	—	—	—																																																																																																																																																																																																																																																
E7XT-11	W07811	—	—	—	—	—	—	—	—	—	—	—																																																																																																																																																																																																																																																
E6XT-G	—	(1)	1.75	0.30	0.03	0.03	0.20	0.50	0.30	0.08	1.8	0.35																																																																																																																																																																																																																																																
E7XT-12	W07812	0.15	1.50	0.30	0.03	0.03	0.20	0.50	0.30	0.08	—	0.35																																																																																																																																																																																																																																																
E7XT-12M																																																																																																																																																																																																																																																												
E6XT-13	W08813	—	—	—	—	—	—	—	—	—	—	—																																																																																																																																																																																																																																																
E7XT-2	W07802	—	—	—	—	—	—	—	—	—	—	—																																																																																																																																																																																																																																																
E7XT-2M																																																																																																																																																																																																																																																												
E7XT-3	W07813	—	—	—	—	—	—	—	—	—	—	—																																																																																																																																																																																																																																																
E7XT-10	W07810	—	—	—	—	—	—	—	—	—	—	—																																																																																																																																																																																																																																																
E7XT-13	W07813	—	—	—	—	—	—	—	—	—	—	—																																																																																																																																																																																																																																																
E7XT-14	W07814	—	—	—	—	—	—	—	—	—	—	—																																																																																																																																																																																																																																																
E6XT-GS	—	—	—	—	—	—	—	—	—	—	—	—																																																																																																																																																																																																																																																
<p>a) Single values are minimum values.</p>																																																																																																																																																																																																																																																												
<p>M: 75-80 % Argon - CO<sub>2</sub></p> <p>If no M Symbol, products E70T-3, E70T-4, E70T-6, E70T-7, E70T-8, E70T-10, E70T-11, E71T-11, E61T-13, E71T-13, E71T-14 are used without gas, the rest is used with CO<sub>2</sub>.</p>																																																																																																																																																																																																																																																												
<p>"J" is used if 27J is provided at -40°C.</p>																																																																																																																																																																																																																																																												
<table border="1" style="width: 100%; border-collapse: collapse;"> <thead> <tr> <th colspan="2">Symbols for hydrogen content of the all-weld metal</th> </tr> <tr> <th>Symbol</th> <th>ml/100g</th> </tr> </thead> <tbody> <tr><td>H4</td><td>16.0</td></tr> <tr><td>H8</td><td>8.0</td></tr> </tbody> </table>		Symbols for hydrogen content of the all-weld metal		Symbol	ml/100g	H4	16.0	H8	8.0																																																																																																																																																																																																																																																			
Symbols for hydrogen content of the all-weld metal																																																																																																																																																																																																																																																												
Symbol	ml/100g																																																																																																																																																																																																																																																											
H4	16.0																																																																																																																																																																																																																																																											
H8	8.0																																																																																																																																																																																																																																																											
<p>(1) Limits of this element was not specified. Look at AWS A6.5 for it.</p>																																																																																																																																																																																																																																																												

**Table of Electrodes for Submerged Arc Welding of Non-alloy and Fine-grain Steels according to TS EN ISO 14171-A**

Alloy Symbol	Chemical Composition % 1) 2)							
	C	Si	Mn	P	S	Mo	Ni	Cr
S0								
S1	0,05-0,15	0,15	0,35-0,60	0,025	0,025	0,15	0,15	0,15
S2	0,07-0,16	0,15	0,80-1,30	0,025	0,025	0,15	0,15	0,15
S3	0,07-0,15	0,15	> 1,30-1,75	0,025	0,025	0,15	0,15	0,15
S4	0,07-0,15	0,15	> 1,75-2,25	0,025	0,025	0,15	0,15	0,15
S1Si	0,07-0,15	0,15-0,40	0,35-0,60	0,025	0,025	0,15	0,15	0,15
S2Si	0,07-0,15	0,15-0,40	0,80-1,30	0,025	0,025	0,15	0,15	0,15
S2Si2	0,07-0,15	0,40-0,60	0,80-1,30	0,025	0,025	0,15	0,15	0,15
S3Si	0,07-0,15	0,15-0,40	> 1,30-1,85	0,025	0,025	0,15	0,15	0,15
S4Si	0,07-0,15	0,15-0,40	> 1,85-2,25	0,025	0,025	0,15	0,15	0,15
S1Mo	0,05-0,15	0,05-0,25	0,35-0,60	0,025	0,025	0,45-0,65	0,15	0,15
S2Mo	0,07-0,15	0,05-0,25	0,80-1,30	0,025	0,025	0,45-0,65	0,15	0,15
S3Mo	0,07-0,15	0,05-0,25	> 1,30-1,75	0,025	0,025	0,45-0,65	0,15	0,15
S4Mo	0,07-0,15	0,05-0,25	> 1,75-2,25	0,025	0,025	0,45-0,65	0,15	0,15
S2Ni1	0,07-0,15	0,05-0,25	0,80-1,30	0,020	0,025	0,15	0,80-1,20	0,15
S2Ni1,5	0,07-0,15	0,05-0,25	0,80-1,30	0,020	0,020	0,15	> 1,20-1,80	0,15
S2Ni2	0,07-0,15	0,05-0,25	0,80-1,30	0,020	0,020	0,15	> 1,80-2,40	0,15
S2Ni3	0,07-0,15	0,05-0,25	0,80-1,30	0,020	0,020	0,15	> 2,80-3,70	0,15
S2Ni1Mo	0,07-0,15	0,05-0,25	0,80-1,30	0,020	0,020	0,45-0,65	0,80-1,20	0,20
S3Ni1,5	0,07-0,15	0,05-0,25	> 1,30-1,70	0,020	0,020	0,15	> 1,20-1,80	0,20
S3Ni1Mo	0,07-0,15	0,05-0,25	> 1,30-1,80	0,020	0,020	0,45-0,65	0,80-1,20	0,20
S3Ni1,5Mo	0,07-0,15	0,05-0,25	1,20-1,80	0,020	0,020	0,30-0,50	1,20-1,80	0,20

1) Including the Cu of the covering, in the chemical composition of end product: Cu?%0,30; Al?%0,030.  
2) Single values shown in the table mean maximum values.

Symbol	Yield Strength, Tensile Strength and Elongation		
	ReL (N/mm <sup>2</sup> )	Rm (N/mm <sup>2</sup> )	A (%)
35	355	440-570	22
38	380	470-600	20
42	420	500-640	20
45	450	530-680	20
50	500	550-720	18
55	550	610-780	18
62	620	690-890	18
68	680	760-960	17
79	790	880-1080	16
89	890	980-1180	15

Symbol for impact properties of all-weld metal	
Symbol	Temperature C
Z	no requirements
A	(+20)
0	0
2	-20
3	-30
4	-40
5	-50
6	-60
7	-70
8	-80

Production/product	
G	Wire Electrodes
O	Oxy-acetylene
E	Electric arc welding
S	Submerged arc welding wires
T	Flux-cored wires
W	TIG Rods
F	Submerged arc welding fluxes

Type of Submerged Welding Powder	Symbol
Manganese-silicate	MS
Calcium-silicate	CS
Zirconium-silicate	ZS
Rutile-silicate	RS
Aluminate-rutile	AR
Aluminate-basic	AB
Aluminate-silicate	AS
Aluminate-flouide-basic	AF
Flouide-basic	FB
Other types	ZS

## Specification for Wires and Fluxes for Submerged Arc Welding According to AWS A5.17

Tensile Test			
Wire-Flux Combination	Tensile Strength psi	Yield Strength psi	Elongation %
F6XX-EXXX	60000-80000	48000	22
F7XX-EXXX	70000-95000	58000	22

Impact Test		
Symbol	Max. Test Temperature °F	Min. Average Energy
0	0	
2	-20	
4	-40	20 ft. lbf
5	-50	
6	-60	
8	-80	
Z	Not noted	

F: Submerged Arc Welding Flux

A: Without Heat Treatment

P: PWHT

F 7 A 2 - EM12

Tensile Test			
Wire-Flux Combination	Tensile Strength MPa	Yield Strength MPa	Elongation %
F43XX-EXXX	430-560	330	22
F48XX-EXXX	480-560	400	22

Impact Test		
Symbol	Max. Test Temperature °F	Min. Average Energy
0	0	
2	-20	
3	-30	27 Joule
4	-40	
5	-50	
6	-60	
Z	Not noted	

F: Submerged Arc Welding Flux

A: Without Heat Treatment

P: PWHT

F 43 A 3 - EM12

Chemical Composition for Submerged Arc Welding Wires (%)								
Symbol	UNS Number	C	Mn	Si	S	P	Cu	Ti
<b>Low-Manganese Electrodes</b>								
EL 8	K01008	0,10	0,25/0,60	0,07	0,03	0,03	0,35	-
EL 8K	K01009	0,10	0,25/0,60	0,10/0,25	0,03	0,03	0,35	-
EL12	K01012	0,04/0,14	0,25/0,60	0,10	0,03	0,03	0,35	-
<b>Medium-Manganese Electrodes</b>								
EM11K	K01111	0,07/0,15	1,00/1,50	0,65/0,85	0,03	0,025	0,35	-
EM12	K01112	0,06/0,15	0,80/1,25	0,10	0,03	0,03	0,35	-
EM12K	K01113	0,05/0,15	0,80/1,25	0,10/0,35	0,03	0,03	0,35	-
EM13K	K01313	0,06/0,16	0,90/1,40	0,35/0,75	0,03	0,03	0,35	-
EM14K	K01314	0,06/0,19	0,90/1,40	0,35/0,75	0,025	0,025	0,35	0,03/0,17
EM15K	K01515	0,10/0,20	0,80/1,25	0,10/0,35	0,03	0,03	0,35	-
<b>High-Manganese Electrodes</b>								
EH10K	K01210	0,07/0,15	1,30/1,70	0,05/0,25	0,025	0,025	0,35	-
EH11K	K11140	0,07/0,15	1,40/1,85	0,80/1,15	0,03	0,03	0,35	-
EH12K	K01213	0,06/0,15	1,50/2,00	0,25/0,65	0,025	0,025	0,35	-
EH14	K11585	0,10/0,20	1,70/2,20	0,10	0,03	0,03	0,35	-
EG	Not Specified							



## Welding of Mild Steels

The most commonly used metallic materials of our era are iron based alloys. Steel has a very important role in them. The property that makes steels this important is their ability to make various types of alloys and their ability to gain various types of properties with the help of heat treatments. As known, while quenched, steel can be used as a tool that can easily process steel that has the same composition with the former one. 4000 types of steel that have different compositions and properties are developed since the industrial revolution. When different properties from the same steel are considered, there occurs a really wide spectrum.

The most important issue for welding is the hardening that is caused by rapid cooling from very high temperatures, which happens in some steels. The resulting hard material, which can go up to 64 HRC depending on the composition of the steel and the cooling rate, is called "martensite". Martensite is quite hard and brittle. The hardest steels are the ones that contain 0,7-0,8% C. The other significant factor in martensite formation aside from carbon is the cooling rate. While steels that include more than 0,3% carbon only harden when they are cooled in the water from a high temperature, hard and brittle martensitic structure occurs with a much slower cooling when steel includes alloying element.

In arc welding methods, metal is first heated to a temperature higher than its melting point; and then cooled down. Experiments and measurements show that the cooling rate of the welded zone on an iron bar is equivalent to the cooling rate of a piece that is heated up to a high temperature and cooled down by being quenched. Hence, it is obvious that this kind of a hard and brittle structure will be produced at the weld zones of the steels that contain carbon and alloying elements of higher amount than a certain value for each.

Welding electrode producers adjust the composition of the filler metal in such a way that even if it mixes a little with the base metal being melted, no hardening occurs at the molten metal after cooling. However, hardening on the base metal that is interconnected to the welded zone can occur since this part that is warmed up to a high temperature and then cooled down. Carbon and manganese are two elements that especially affect the hardening capability of the unalloyed steel. There are various opinions on the required maximum carbon content of the unalloyed steels for them to be welded without taking any precautions. For example, while the maximum carbon content for non-degassed steels are 0,25% and the maximum carbon content for non-degassed steels are 0,22% in Sweden, it is allowed for this value to go up to 0,30% in the USA.

Alloying elements such as chromium, molybdenum, vanadium, nickel and copper, when they are contained in low-alloyed steels, cause hardening of the heat-affected zone (HAZ) although carbon content is lower. In addition to crack formation right after the welding in this hard and brittle material, that is caused by heat, brittle fractures occur when any deformation process is performed on this structure material in case during use of welded joints, any smallest deformation stress causes such structures to undergo brittle fracture; and, this results in significant damages.

The Weldability Commission of International Institute of Welding advises that the hardness of the heat-affected zone should not be higher than 350 HVC.

The only solution for decreasing the hardness of HAZ is to decelerate the cooling process after welding. The safest way for doing this is preheating the piece and welding it at this temperature. Various theoretical and applied researches have been made in order to find a constant that gives the hardening tendency of the steel and hence to obtain a formula which gives the preheating temperature that should be applied.

A solution that easily shows results is developed as a result of all these studies. In this solution, which is named Carbon Equivalent, the amounts of the alloying elements which exist in the chemical composition of the steel consist are put into a formula; and, a constant is calculated, depending on whose value a preheating temperature is can be chosen determined according to this constant.

Although there are various formulas for the calculation of carbon equivalent in literature, all of them are empirical relations that give close and satisfactory results in practice. The Carbon Equivalent Formula which the International Institute of Welding (IIW) requires proposes for low-alloyed carbon steels is as follows:

$$C_{eq} = C + Mn/6 + Cr/5 + Mo/5 + V/5 + Ni/15 + Cu/15$$

The alloying elements limits in order for the above-given formula to be valid is are as follows:

$$C < 0,5\%; Mn < 1\%; Cr < 1\%; Ni < 3,5\%; Mo < 0,6\%$$

The preheating temperature that should be applied according to  $C_{eq}$  is as follows:

$C_{eq}(\%)$	Preheating Temperature ( $^{\circ}C$ )
less than 0,45	not required at normal conditions
between 0,45 and 0,60	100-200
more than 0,60	200-350 (can be increased up to 600 at special conditions)

If the carbon equivalent, which is just an approach, is used; maximum preheating temperatures should be chosen as to be the upper limits of the value ranges that are valid for the conditions applied in the circumstances that are specified below, and in some special conditions, they should be exceeded, in order to eliminate any risks.

- If the base metal is Thomas steel or hot-cast steel,
- If the steel has a coarse-grained microstructure,
- If the base metal piece (the workpiece) is big large and unorderedly structure complex- shaped,
- If the workpiece is very thick,
- If low levels of energy should be applied during welding,
- If the filler metal is not firm sufficiently tough
- If the temperature of the welding environment is too low,

As seen, carbon equivalent only includes the chemical composition of the steel. However it does not involve factors that primarily affect the cooling rate such as welding heat input, form of the weld groove, the geometry and thickness of the workpiece. Although there are some empirical formulas in the literature, the appropriate preheating temperatures according to electrode diameter (heat input), piece thickness, groove form according to  $C_{eq}$  is shown in the table.

The points below should be considered during the welding of the steels that have tendency to harden and have a  $C_{eq}$  value that is more than 0,45% for a safe welding .

- An appropriately chosen preheating temperature should be applied to all the whole pieces.
- The temperature should be kept at the same level during the welding process.
- A pre-dried basic-coated electrode should be used.
- If a piece will be annealed for stress relieving, it should be put into the furnace as soon as the welding process is finished before the piece cools down (it should stay in the furnace at the temperatures of 600-650  $^{\circ}C$  temperature for 2 hours for each 2 mm.). It should be taken out after it cooled down to 300  $^{\circ}C$  in the furnace, and should be left for air-cooling in a stable environment.

## Recommended Pre-annealing Temperatures according to Carbon Equivalent, Electrode Diameter, Particle Thickness and Groove Type

C <sub>eq</sub>	Electrode Diameter (mm)	Pre-annealing Temperature °C							
		Particle Thickness/Butt Seam				Particle Thickness/Inside Corner Seam			
		6 mm	12 mm	25 mm	50 mm	6 mm	12 mm	25 mm	50 mm
0.35	3.20	•	•	•	•	•	•	•	100
	4	•	•	•	•	•	•	•	•
	5	•	•	•	•	•	•	•	•
	6	•	•	•	•	•	•	•	•
0.40	3.20	•	•	•	150	•	•	100	200
	4	•	•	•	•	•	•	•	150
	5	•	•	•	•	•	•	•	100
	6	•	•	•	•	•	•	•	100
0.45	3.20	•	•	150	250	•	100	250	300
	4	•	•	100	200	•	•	200	250
	5	•	•	•	150	•	•	100	200
	6	•	•	•	100	•	•	•	150
0.50	3.20	•	•	250	350	•	150	350	(450)
	4	•	•	150	300	•	100	250	400
	5	•	•	100	200	•	•	200	350
	6	•	•	•	100	•	•	150	300
0.55	3.20	•	150	400	(550)	100	300	(550)	x
	4	•	•	300	(450)	•	200	(450)	x
	5	•	•	150	350	•	100	350	(600)
	6	•	•	150	300	•	•	300	(600)
0.60	3.20	150	400	x	x	350	x	x	x
	4	100	250	x	x	250	(600)	x	x
	5	•	100	(500)	(600)	150	300	(600)	x
	6	•	•	350	500	•	150	500	x
0.65	3.20	300	x	x	x	x	x	x	x
	4	200	350	x	x	x	x	x	x
	5	•	150	(600)	x	200	(600)	x	x
	6	•	•	(500)	x	100	300	x	x
0.70	3.20	400	x	x	x	x	x	x	x
	4	300	500	x	x	x	x	x	x
	5	200	400	x	x	400	(600)	x	x
	6	•	200	(600)	x	200	400	x	x
0.75	3.20	600	x	x	x	x	x	x	x
	4	500	x	x	x	x	x	x	x
	5	400	500	x	x	(600)	x	x	x
	6	200	400	x	x	(450)	(600)	x	x

• = Pre-Annealing is not recommended

x = It is not used in practice since required pre-annealing temperature is too high

In production plants, damaged parts must be repaired immediately operations. The damaged part should be repaired by welding, and put into its place. The composition of the material of the piece is not generally known. The welding shop cannot be expected to analyze and determine the chemical composition of the piece before welding. In such conditions, the first thing that has to be done is to perform spark and file tests on the material. A file that is grinded to the surface of the material makes it easy to determine its hardening process is applied to the piece before. In the spark test, the piece is touched against the spinning surface of a grinding wheel. It is touched to the wheel in such a way that the length of the sparks is 30 cm. An experienced person who looks at the sparks in a dim light can estimate the elements that are in the composite and the proportions of these elements. Even an inexperienced person can identify carbon steel from alloyed steel and the low-middle and high-carbon steels from each other after a few hours work unless they are dischromated. Another good way of analysing is to compare the piece with specimens from metals whose chemical compositions are known.

Magnetic-particle test is generally used in distinguishing ferritic steels that can harden after heat treatment from austenitic steels that cannot harden (despite their high carbon equivalent). Austenitic steels are not pulled by magnets since they are antimagnetic. The point that should be bewared is not to put the magnet to the zones that are mechanically worked or to the zones that hardened as a result of transformation because these zones can locally be magnetic as a result of transformation.

- Use the largest-diameter electrode to which that is suitable for both the weld groove's shape and the part's dimensions allow.
- Choose the max. value of welding ampacity that the electrode producer requested since the cool-down rate decreases when the energy applied to the weld zone increases.
- Use basic austenitic coated electrodes. This may prevent the cracks in the weld bead because austenitic steels are more tough.
- Welded joint should never be done through one pass. The welding with as many passes as it can have should be chosen because new pass has a tempering effect on the HAZ of the earlier pass and hence the brittleness and hardness of this zone decreases. Various researchers advise that a tempering pass should be applied to the weld bead without touching the base metal after the welding.

## Welding of Fine-Grained High-Strength Structural Steels

Fine-grained high-strength structural steels were developed in order to meet the increasing needs for light steel containers and high-strength containers and reactors in the industry. Carbides, nitrides and carbonitrides that are scattered around in a very fine structure especially in grain boundaries in the internal microstructure of fine-grained structural steels, and are transmitted to the solution only at the temperatures higher than 1100 °C; prevent grain growth even at the heat temperatures at the austenite zone. High-strength and firm tough steels group occurs are obtained as a result of this. In a second group of fine-grained structural steels, the yield and tensile strength and the firmness toughness of the steel are increased without causing the steel that will form a low-carbon martensite in the inner structure lose its weldability. Since the Martensite start temperature is 400 °C in this quenched fine-grained structural steels group, the martensite that is formed is automatically tempered when it is slowly cooled down at a temperature lower than this. Therefore fine grained scattered around carbide precipitates that increase the strength of the inner structure form. Carbon content should not exceed 0,20 for their weldability in fine-grained structural steels. Steels that have the desired qualities are obtained by low or limited hardening by putting alloying elements as little as possible, fine-grain formation, decomposition of nitride particles that prevent grain growth and optimization between heat treatments.

Fine-grained structural steels have a very good weldability because of the limitations to their carbon and alloying element contents. Classical structural steels are preheated and welded with high energy input in order to slow down the cooling down rate. On the other hand, slow down of the cooling down rate in fine-grained structural steels causes them to turn into a ferrite and high-carbon martensite or bulk martensite or bulk bainite areas at the inner structure in weld line of the base metal. This causes the firmness toughness to decrease and the strength quality to deteriorate. This shows itself especially on the HAZ of the joints that are preheated at a very high temperature and welded with a single pass. If the welding process is multi-passed, quality of the weld zone gets better than the weld zone of the single pass welding since each pass tempers the weld zone of the former one. An appropriate preheating for thick and highly stressed constructions is an effective precaution for the cracks that can be caused by various reasons.

Specific-energy input  $E$  (k/cm) that is calculated by taking the ratio of the multiplication of welding current strength and arc voltage and relative thermal activity coefficient of welding method to the welding speed; preheating temperature and piece thickness are the three significant factors that affect the cooling down rate of the weld zone.

These three factors should be considered together to be able to control the qualities of the weld zone of the fine-grained structural steels. Cooling down rate  $t_{8/5}$  at 800-500 °C is very important for affecting the qualities of the weld zone of the steels. The decrease in time causes the hardness and the strength to increase but the tendency to crack to increase.

Steel producers state the appropriate  $t_{8/5}$  value for the fine-grained structural steels that they produce in the certificate of the steel. There are mathematical formulas, computer programs that calculate the specific energy that is applied to the weld, piece thickness, preheating temperature and  $t_{8/5}$  and nomograms on this issue. 1kJ/cm for each mm of plate thickness as specific energy input is averagely chosen in practice. For example,  $E=25$ kJ/cm specific energy for a 25mm thick plate. A preheating process that is between 80 °C and 200 °C is applied to the joint for the processes that are under +5 °C in weld of the fine-grained structural steels. For the processes higher than this temperature, yield limit and piece thickness are criteria for the decision whether preheating process is applied or not.

**GeKa Electrodes for Welding of Fine-Grain/Non-Alloy and Low Alloy Steels**

GeKa Electrodes		ELT	PANTERA	LOTUS	EGE	GRANIT	TARGA	STEP	INTER	CEM	ELT R 180	LINK 6010	LINK 6011	LINK 7010-G	LINK 7010 A	LINK 8010-G	LASER B 43	LASER B 47	LASER B 47A	LASER B 50	LASER B 55	LASER B 60	LASER B 63	LASER B 65	TEMP B 70	TEMP B 75	TEMP B 85	TEMP N10U	TEMP B 2	TEMP B 3
DIN	EN																													
SK 37.2	S 235 JR																													
WTSK 37.2-37.3	S 235 JRV																													
SK 44.2	S 275 JR																													
SK 50.2	E 295																													
SK 60-2	E 335																													
SK 70-2	E 360																													
SK 37.3	S 235 J2G3																													
SK 44.3	S 275 J2G3																													
SK 52.3	S 355 J2G3																													
SK 52 Cu 3	S 355 J2G3 Cu																													
WTSK 52.3-52.3A	S 355 JRV																													
HI	P 235 GH																													
HI	P 265 GH																													
17 Min 4	P 265 GH																													
19 Min 5	P 310 GH																													
19 Min 6	P 355 GH																													
WSKE 255	P 255 NH																													
WSKE 305	P 305 NH																													
WSKE 380	P 380 NH																													
WSKE 420	P 420 NH																													
WSKE 460	P 460 NH																													
WSKE 500	P 500 NH																													
SK 37.0	P 235 T1																													
SK 44.0	P 275 T1																													
SK 52.0	P 355 T1																													
SK 37.4	P 235 T2																													
SK 44.4	P 275 T2																													
SK 52.4	P 355 T2																													
SK 35.8	P 255 G1TH																													
SK 45.8	P 265 G1TH																													
SK E 210.7	L 210																													

**GeKa Electrodes for Welding of Fine-Grain/Non-Alloy and Low Alloy Steels**

GeKa Electrodes																																						
DIN	EN	ELIT	PANTERA	LOTUS	EGE	GRANIT	TARGA	STEP	INTER	ELIT R 410	CEM	ELIT R 180	LNK 6010	LNK 6011	LNK 7010-G	LNK 7010-A	LASER B 43	LASER B 47	LASER B 50	LASER B 47-A	LASER B 60	LASER B 65	LASER B 160	TEMPO B 80	TEMPO B 63	TEMPO B 65	TEMPO B 70	TEMPO B 75	TEMPO B 85	TEMPO NCU	TEMPO B 2	TEMPO B 3						
SIE 240.7	L 245 NB B	*	*	*	*	*	*	*	*	*	*	*	*	*	*	*	*	*	*	*	*	*	*	*	*	*	*	*	*	*	*	*	*	*	*	*		
SIE 290.7	L 290 NB	*	*	*	*	*	*	*	*	*	*	*	*	*	*	*	*	*	*	*	*	*	*	*	*	*	*	*	*	*	*	*	*	*	*	*		
SIE 320.7	L 320	*	*	*	*	*	*	*	*	*	*	*	*	*	*	*	*	*	*	*	*	*	*	*	*	*	*	*	*	*	*	*	*	*	*	*		
SIE 360.7	L 360 NB	*	*	*	*	*	*	*	*	*	*	*	*	*	*	*	*	*	*	*	*	*	*	*	*	*	*	*	*	*	*	*	*	*	*	*		
SIE 415.7	L 415 NB	*	*	*	*	*	*	*	*	*	*	*	*	*	*	*	*	*	*	*	*	*	*	*	*	*	*	*	*	*	*	*	*	*	*	*		
SIE 460.7	L 465 NB	*	*	*	*	*	*	*	*	*	*	*	*	*	*	*	*	*	*	*	*	*	*	*	*	*	*	*	*	*	*	*	*	*	*	*		
SIE 290.7 TM	L 290 MB X42	*	*	*	*	*	*	*	*	*	*	*	*	*	*	*	*	*	*	*	*	*	*	*	*	*	*	*	*	*	*	*	*	*	*	*		
SIE 320.7 TM	L 320 MB X46	*	*	*	*	*	*	*	*	*	*	*	*	*	*	*	*	*	*	*	*	*	*	*	*	*	*	*	*	*	*	*	*	*	*	*		
SIE 360.7 TM	L 360 MB X52	*	*	*	*	*	*	*	*	*	*	*	*	*	*	*	*	*	*	*	*	*	*	*	*	*	*	*	*	*	*	*	*	*	*	*	*	
SIE 385.7 TM	L 385 TM X56	*	*	*	*	*	*	*	*	*	*	*	*	*	*	*	*	*	*	*	*	*	*	*	*	*	*	*	*	*	*	*	*	*	*	*	*	
SIE 415.7 TM	L 415 MB X60	*	*	*	*	*	*	*	*	*	*	*	*	*	*	*	*	*	*	*	*	*	*	*	*	*	*	*	*	*	*	*	*	*	*	*	*	
SIE 445.7 TM	L 450 MB X65	*	*	*	*	*	*	*	*	*	*	*	*	*	*	*	*	*	*	*	*	*	*	*	*	*	*	*	*	*	*	*	*	*	*	*	*	
SIE 480.7 TM	L 485 MB X70	*	*	*	*	*	*	*	*	*	*	*	*	*	*	*	*	*	*	*	*	*	*	*	*	*	*	*	*	*	*	*	*	*	*	*	*	
SIE 255	S 255 N	*	*	*	*	*	*	*	*	*	*	*	*	*	*	*	*	*	*	*	*	*	*	*	*	*	*	*	*	*	*	*	*	*	*	*	*	
SIE 355	S 355 N	*	*	*	*	*	*	*	*	*	*	*	*	*	*	*	*	*	*	*	*	*	*	*	*	*	*	*	*	*	*	*	*	*	*	*	*	
SIE 380 / 420	S 380 N / 420 N	*	*	*	*	*	*	*	*	*	*	*	*	*	*	*	*	*	*	*	*	*	*	*	*	*	*	*	*	*	*	*	*	*	*	*	*	
SIE 460	S 460N / 460NH	*	*	*	*	*	*	*	*	*	*	*	*	*	*	*	*	*	*	*	*	*	*	*	*	*	*	*	*	*	*	*	*	*	*	*	*	*
SIE 500	S 500 N	*	*	*	*	*	*	*	*	*	*	*	*	*	*	*	*	*	*	*	*	*	*	*	*	*	*	*	*	*	*	*	*	*	*	*	*	*
TSIE 255	S 255 NL	*	*	*	*	*	*	*	*	*	*	*	*	*	*	*	*	*	*	*	*	*	*	*	*	*	*	*	*	*	*	*	*	*	*	*	*	
TSIE 355	SP 355 NL (1)	*	*	*	*	*	*	*	*	*	*	*	*	*	*	*	*	*	*	*	*	*	*	*	*	*	*	*	*	*	*	*	*	*	*	*	*	
TSIE 380	S 380 NL	*	*	*	*	*	*	*	*	*	*	*	*	*	*	*	*	*	*	*	*	*	*	*	*	*	*	*	*	*	*	*	*	*	*	*	*	
TSIE 420	S 420 NL1	*	*	*	*	*	*	*	*	*	*	*	*	*	*	*	*	*	*	*	*	*	*	*	*	*	*	*	*	*	*	*	*	*	*	*	*	
TSIE 460	S 460 NL1	*	*	*	*	*	*	*	*	*	*	*	*	*	*	*	*	*	*	*	*	*	*	*	*	*	*	*	*	*	*	*	*	*	*	*	*	
TSIE 500	S 500 NL1	*	*	*	*	*	*	*	*	*	*	*	*	*	*	*	*	*	*	*	*	*	*	*	*	*	*	*	*	*	*	*	*	*	*	*	*	
ESIE 255 / 315	S 255/315 NL1	*	*	*	*	*	*	*	*	*	*	*	*	*	*	*	*	*	*	*	*	*	*	*	*	*	*	*	*	*	*	*	*	*	*	*	*	
ESIE 285 / 355	P 275/355 NL 2	*	*	*	*	*	*	*	*	*	*	*	*	*	*	*	*	*	*	*	*	*	*	*	*	*	*	*	*	*	*	*	*	*	*	*	*	*
ESIE 380 / 420	S 380/420 NL 1	*	*	*	*	*	*	*	*	*	*	*	*	*	*	*	*	*	*	*	*	*	*	*	*	*	*	*	*	*	*	*	*	*	*	*	*	*
ESIE 460	P 460 NL 2	*	*	*	*	*	*	*	*	*	*	*	*	*	*	*	*	*	*	*	*	*	*	*	*	*	*	*	*	*	*	*	*	*	*	*	*	*
ESIE 500	S 500 NL1	*	*	*	*	*	*	*	*	*	*	*	*	*	*	*	*	*	*	*	*	*	*	*	*	*	*	*	*	*	*	*	*	*	*	*	*	*
ESIE 620 V	S 620 CI/CI.1	*	*	*	*	*	*	*	*	*	*	*	*	*	*	*	*	*	*	*	*	*	*	*	*	*	*	*	*	*	*	*	*	*	*	*	*	
ESIE 690 V	S 690 CI/CI.1	*	*	*	*	*	*	*	*	*	*	*	*	*	*	*	*	*	*	*	*	*	*	*	*	*	*	*	*	*	*	*	*	*	*	*	*	*

**GeKa Electrodes for Welding of Fine-Grain/Non-Alloy and Low Alloy Steels**

GeKa Electrodes																																								
DIN	EN	ELIT	PANTERA	LOTUS	EGE	GRANIT	TARGA	STEP	INTER	ELIT R 110	CEM	ELIT R 180	LINK 6010	LINK 6011	LINK 7010-G	LINK 7010 A	LINK 8010-G	LASER B 43	LASER B 47	LASER B 50	LASER B 47-A	LASER B 60	LASER B 55	LASER B 160	TEMPO B 60	TEMPO B 63	TEMPO B 65	TEMPO B 70	TEMPO B 75	TEMPO B 85	TEMPO NICU	TEMPO B 2	TEMPO B 3							
GL-A	S 235 JRS1/S2	*	*	*	*	*	*	*	*	*	*	*	*	*	*	*	*	*	*	*	*	*	*	*	*	*	*	*	*	*	*	*	*	*	*	*	*			
GL-D	S 235 J2S1/S2	*	*	*	*	*	*	*	*	*	*	*	*	*	*	*	*	*	*	*	*	*	*	*	*	*	*	*	*	*	*	*	*	*	*	*	*			
GL-E	S 235 J4S	*	*	*	*	*	*	*	*	*	*	*	*	*	*	*	*	*	*	*	*	*	*	*	*	*	*	*	*	*	*	*	*	*	*	*	*	*		
GL-A32	S 315 G1S	*	*	*	*	*	*	*	*	*	*	*	*	*	*	*	*	*	*	*	*	*	*	*	*	*	*	*	*	*	*	*	*	*	*	*	*	*		
GL-D32	S 315 G2S	*	*	*	*	*	*	*	*	*	*	*	*	*	*	*	*	*	*	*	*	*	*	*	*	*	*	*	*	*	*	*	*	*	*	*	*	*	*	
GL-E32	S 315 G3S	*	*	*	*	*	*	*	*	*	*	*	*	*	*	*	*	*	*	*	*	*	*	*	*	*	*	*	*	*	*	*	*	*	*	*	*	*	*	
GL-A36	S 355 G1S	*	*	*	*	*	*	*	*	*	*	*	*	*	*	*	*	*	*	*	*	*	*	*	*	*	*	*	*	*	*	*	*	*	*	*	*	*	*	
GL-D36	S 355 G2S	*	*	*	*	*	*	*	*	*	*	*	*	*	*	*	*	*	*	*	*	*	*	*	*	*	*	*	*	*	*	*	*	*	*	*	*	*	*	
GL-E36	S 355 G3S	*	*	*	*	*	*	*	*	*	*	*	*	*	*	*	*	*	*	*	*	*	*	*	*	*	*	*	*	*	*	*	*	*	*	*	*	*	*	
C 22 / C 35	C 22 / C 35	*	*	*	*	*	*	*	*	*	*	*	*	*	*	*	*	*	*	*	*	*	*	*	*	*	*	*	*	*	*	*	*	*	*	*	*	*	*	
C 45 / C 60	C 45 / C 60	*	*	*	*	*	*	*	*	*	*	*	*	*	*	*	*	*	*	*	*	*	*	*	*	*	*	*	*	*	*	*	*	*	*	*	*	*	*	*
GS 38	GE 200	*	*	*	*	*	*	*	*	*	*	*	*	*	*	*	*	*	*	*	*	*	*	*	*	*	*	*	*	*	*	*	*	*	*	*	*	*	*	*
GS 45	GE 240	*	*	*	*	*	*	*	*	*	*	*	*	*	*	*	*	*	*	*	*	*	*	*	*	*	*	*	*	*	*	*	*	*	*	*	*	*	*	*
GS 52	GE 260	*	*	*	*	*	*	*	*	*	*	*	*	*	*	*	*	*	*	*	*	*	*	*	*	*	*	*	*	*	*	*	*	*	*	*	*	*	*	*
GS 60	GE 300	*	*	*	*	*	*	*	*	*	*	*	*	*	*	*	*	*	*	*	*	*	*	*	*	*	*	*	*	*	*	*	*	*	*	*	*	*	*	*
GS 70	GE 340	*	*	*	*	*	*	*	*	*	*	*	*	*	*	*	*	*	*	*	*	*	*	*	*	*	*	*	*	*	*	*	*	*	*	*	*	*	*	*
SGSteh 800	R 0800	*	*	*	*	*	*	*	*	*	*	*	*	*	*	*	*	*	*	*	*	*	*	*	*	*	*	*	*	*	*	*	*	*	*	*	*	*	*	*
20 NiMoNi 55	20 NiMoNi 5-5	*	*	*	*	*	*	*	*	*	*	*	*	*	*	*	*	*	*	*	*	*	*	*	*	*	*	*	*	*	*	*	*	*	*	*	*	*	*	*
22 NiMoCr 37	22 NiMoCr 4-7	*	*	*	*	*	*	*	*	*	*	*	*	*	*	*	*	*	*	*	*	*	*	*	*	*	*	*	*	*	*	*	*	*	*	*	*	*	*	*
15 NiCuMoNb 5	15 NiCuMoNb5S	*	*	*	*	*	*	*	*	*	*	*	*	*	*	*	*	*	*	*	*	*	*	*	*	*	*	*	*	*	*	*	*	*	*	*	*	*	*	*
17 NiMoV 54	17 NiMoV 6-4	*	*	*	*	*	*	*	*	*	*	*	*	*	*	*	*	*	*	*	*	*	*	*	*	*	*	*	*	*	*	*	*	*	*	*	*	*	*	*
IN-A-XTTRA 55-70		*	*	*	*	*	*	*	*	*	*	*	*	*	*	*	*	*	*	*	*	*	*	*	*	*	*	*	*	*	*	*	*	*	*	*	*	*	*	*
TTSL 35 Ni / 45 N	S 225 NL	*	*	*	*	*	*	*	*	*	*	*	*	*	*	*	*	*	*	*	*	*	*	*	*	*	*	*	*	*	*	*	*	*	*	*	*	*	*	*
TTSL 35 V / 45 V	S 225 NL	*	*	*	*	*	*	*	*	*	*	*	*	*	*	*	*	*	*	*	*	*	*	*	*	*	*	*	*	*	*	*	*	*	*	*	*	*	*	*
10-16 Ni 14		*	*	*	*	*	*	*	*	*	*	*	*	*	*	*	*	*	*	*	*	*	*	*	*	*	*	*	*	*	*	*	*	*	*	*	*	*	*	*
14 Ni 6		*	*	*	*	*	*	*	*	*	*	*	*	*	*	*	*	*	*	*	*	*	*	*	*	*	*	*	*	*	*	*	*	*	*	*	*	*	*	*
13 NiNiE 63		*	*	*	*	*	*	*	*	*	*	*	*	*	*	*	*	*	*	*	*	*	*	*	*	*	*	*	*	*	*	*	*	*	*	*	*	*	*	*



## Welding of Heat and Creep Resisting Steels

Steel has to be heat-resisting in the fields of application such as power plants, high pressure steam boilers, refineries and steam turbines. Hence the weld metal should be as heat resisting as the base metal.

The yield and tensile strengths of the unalloyed structural steels decrease significantly at high temperatures. When alloying elements such as Cr, Mo, W or V to the steel, heat resistance values get much better. One has to consider only the yield and tensile strengths of the steel at the high temperature applications. Creep gets intensified for the materials as a result of the combined effect of temperature and mechanical stress. The creep characteristics of all high temperature steels are determined and put into the material standards and specifications in the last 20 years. In addition to these studies, similar tests are applied to the test rods that are provided from the weld metal that is produced with creep resisting electrodes. It is found out that the results have the same values as the test results from the heat and creep resisting steels, and the results for the stabilized austenitic weld metal have even much higher values than those.

These steels are classified depending on their compositions and hence their operative temperature. Cr, Mo, W, Co, Nb, Ta, Ti and Al affect both the matrix composition of the steel and carbide formation and develop its heat and creep resistance qualities. A little amount of Mo, V and Cr addition to the composition of the steel is enough for the temperatures up to 500 °C. Mo is especially efficient in increasing heat resistance quality. Material should be resistant to oxidation for the temperatures more than 550 °C. The best solution for this is to choose steels that include 12%Cr and Mo, V and Nb/Ta. Steels transform and start loose their creep resisting quality after 600 °C. Hence chromium-nickel austenitic steels are preferred for these temperatures. This product is steel that includes 16%Cr and 13%Ni, and of which basic type's creep resisting qualities are developed by adding Mo, V and Nb/Ta. (X8CrNiNb 16 13, X8CrNiMoVNb 16 13). Only alloys that are Cr-, Ni-, Co-based including Mo, V and Nb/Ta show the appropriate creep resistance for the temperatures that are higher than 700 °C.

All 12% Cr and heat- and creep -resisting low-alloyed steels are generally welded after they are quenched and tempered. The heat-affected zone of these steels with hardening tendencies hardens if there are no precautions. Internal stresses that occur during welding process and the adjustment processes after the welding cause the risk of cracking at this zone. In order to prevent the danger of this, an appropriate groove should be chosen, a welding plan should be made, preheating and cooling should be carried out under control; and, stress-relief heating should be applied when it is necessary.

Stabilized austenitic steels show better qualities at high temperatures when that are welded after solution heat treatment is performed on them. Because of the tendency to crack in high temperatures of this type of materials, heat input should be low during the welding process. Since the low thermal conductivity of this type of materials can cause regional heat rises, the weld heat should not be allowed to accumulate at the welded zone. For these cases, short arc and electrodes that have diameters no longer than 4 mm should be applied at an 80-90 °C angle, and weld beads that are as narrow as possible should be produced with oscillations no higher than three times of the wire diameter. Welding is generally performed without preheating. However, preheating to 100-200 °C should be applied to the pieces that are thicker than 25 mm; but, the temperature of the welding zone should not exceed 300-350 °C in those cases.

Co-based, creep-resisting materials such as X40 Cr Ni Co Nb, should be preheated up to 200- 400 °C because of their high content of carbon.

**GeKa Electrodes for welding of Heat Resisting Steels**

Steel Type		STEELS				ELECTRODES							
		Norms of Steel				Max. Operating Temp. °C	OPUS MOB	OPUS MOR	TEMPO B 65	OPUS CM	OPUS C	OPUS 2 CM	OPUS 5 CM
		Material No.	EN	ASTM / AISI	UNS								
Boiler Plates, Heat Resisting Steels EN 10028-2	1.0405	P255G1TH			500	•							
	1.0461	S255N			400	•							
	1.0481	P295GH			500	•							
	1.0482	P310GH			500	•							
	1.5415	16Mo3	A 335, Gr P1		530	•							
	1.7335	13CrMo4-5	A 335, Gr P11 P12		560	•	•						
	1.7380	10CrMo9-10			590						•		
Heat Resisting Steel Castings EN 10213-2	1.0619	GP240GH			450	•							
	1.5419	G20Mo5	A 217, Gr WC1		500	•							
	1.7357	G17CrMo5-5	A 217, Gr WC6		550				•				
	1.7379	G17CrMo9-10			600					•			
	1.7218	25CrMo4			300						•		
Steels for High Pressure Hydrogenation Plates EN 10028-2 EN 10083-1	1.7273	24CrMo10			400						•		
	1.7362	12CrMo19.5			600							•	
	1.6368	15NiCuMoNb5-6-4			500	•							
	1.6311	20MnMoNi4-5	A 508 Cl 3		550	•							
Heat Resisting Special Steels EN 10028-2 EN 10260-3	1.7375	12CrMo9-10			590							•	
	1.6389	15NiCuMoNb55			375							•	
Special Nuclear Reactor Steels SEW 028	1.6310	20MnMoNi5-5	A 533 Gr B Cl 1		375							•	
	1.0407	C-16			---	•						•	
Caustic Resisting Steels EN 10277-2	1.0569	S355J2G3C			---	•						•	

## Welding of Cryogenic Steels

Especially the production of the welding vessels that are used in storage and transportation of liquefied gases requires material that does not lose its qualities at very low temperatures and weld joints that are appropriate for it. As it is known, the tensile strength of steels increases but the ductility and firmness toughness of them decrease as the temperature decreases. For these reasons, the most important quality of the material for applications under the temperature of 0 °C is for it to protect its firmness toughness that is determined by impact test at the desired level. Various surveillance organizations estimate that these types of steels give the result of minimum 27J at ISO-V impact test at the lowest operation temperatures. The impact test is thought to be inadequate recently, and this type of steels is assessed by various fracture mechanics tests. Steels that are used depending on the ambient temperature they are in, and the appropriate GeKa Electrodes for their welding is shown in the table.

- The thin sheet metals that are used in this production branch are not generally preheated before welding. A preheating process between 80 and 150 °C is necessary as the cut view gets thicker and the carbon content exceeds 20 %.
- Low hydrogen, well dried, basic coated electrodes are used in welding.
- Weld metal is chosen in such a way that it provides both the desired strength qualities and the necessary firmness toughness at the operation temperature.
- The most important point for these steels is to keep the heat input at the lowest level in order for HAZ not to have grain growth. Even if a preheating process is performed before the welding, the interpass temperature should not exceed 150 °C.
- Stress relief heating should be applied on some conditions in order to develop the qualities of the steel depending on the type of the steel and the specifications. The temperature degree and duration that the steel producer proposed should in no way be exceeded.
- Welding should be performed in a flat position as horizontal as possible by using positioners. The reason is that both controlling the heat input and providing a faultless welding is only possible in this position. These types of steels should never be welded in overhead, horizontal vertical and vertical up positions. If vertical welding position is necessary, they should only be welded in vertical down position.

Weld bead is done straight without oscillating the electrode in order to limit the heat input during welding process. In case of vertical welding, vertical down welding position is preferred in order to decrease the heat input. Electrical arc welding with coated electrodes is still the most preferred welding method for welding of these types of steels. Submerged arc welding applications with TIG, MIG and special powders are also done recently.

## Welding of Stainless Steels

The most important quality of stainless steels is that they do not rust, and that they are resistant to oxidation and corrosion. This quality is acquired by adding more than 12% chromium to the content of the steel. As the amount of chromium increases, the oxidation resistance at high temperatures also increases. Existence of the steel causes corrosion resistance especially in acidic environments. Besides nickel, molybdenum addition also protects steel from some types of corrosion. However, steels that contain more than 6.5% molybdenum cannot be produced economically.

Chromium causes steel to keep its mechanical qualities at very high temperatures. Hence chromium stainless steels are also used as creep resisting steels at high temperatures.

Stainless steels that have more than 170 types are widely used in industry for various purposes. The most commonly-used ones of the stainless steel types that are used in industry are generally divided into three main groups:

- Martensitic Chromium Stainless Steels.
- Ferritic Chromium Stainless Steels.
- Austenitic Chromium-Nickel Stainless Steels.

In constructions in which the stainless steels are used, modern welding methods such as electron beam welding and laser beam welding are also used besides arc welding with coated electrodes, gas metal arc welding methods (TIG, MIG), submerged arc welding and plasma welding.

Physical qualities of the stainless steels of different types are also different from each other. This plays an important role in welding processes.

Heat conductivity factor of chromium stainless is half of the unalloyed steels. This value is 50% more in austenitic chromium-nickel steels than the value in low-carbon alloy steels. This is of particular concern to constructor as well as the welder.

Low-carbon alloy steels have low resistance to electrical conductivity. This value is 4-7 times higher in stainless steels. Thus stainless steel electrodes redden more quickly, are produced shorter, and are loaded with 25% less strength of current than the normal electrodes.

## Welding of Martensitic Chromium Stainless Steels

Stainless steels in this group contain Cr amount between 11.5% and 18%. Carbon amount in their composition is between 0.1% and 1.2%.

Main effective element in welding of martensitic stainless steels is carbon. Amount of carbon affects the hardness of HAZ, and can be controlled by welding method to an extent. If the hardness of HAZ increases, and, firmness toughness decreases.

Martensitic is relatively less hard in low-carbon martensitic stainless steels. Hence their tendency to crack is less. These steels are normally preheated at 200-400 °C temperature before welding. Soon after the welding a stress-relieving process can be performed before the joint cools down by heating it 800-820 °C for four hours and cooling it slowly in the furnace.

Flux-coated electrodes and TIG welding wires of GeKa are safely used in welding of martensitic chromium stainless steels. Especially ELOX B 410 and GeKaTec 410 HD are coated electrodes that are appropriate for welding of low-carbon martensitic stainless steels. In addition to these, austenitic chromium-nickel stainless coated GeKa electrodes such as GeKa ELOX R 307, ELOX B 307, ELOX R 309 L, ELOX R 312, ELOX B 347, ELOX R 347 provide quality weld joints in conditions such that the strength of the weld bead is not required to be too strong and the joint does not operate in a sulfuric environment. The fact that the yield point of austenitic welding metal is low prevents the danger of cracking which is caused by tensile stress that will happen after the welding. If the joint operates in sulfuric environments, weld beads in which the base metal composition is the same is provided with GeKa stainless chromium special products. The application tables that are given can be used while choosing these products. You can easily solve the problems you experienced with the help of the experts of our company.

## **Welding of Ferritic Chromium Stainless Steels**

This type of steels contains 16-30 % Cr and 0.5-0.25 % C. Its internal composition microstructure is normally made up of ferrite and carbide.

The most significant qualities of these steels are that they are not hardened by quenching since phase transformation is not seen when they are solid, and their corrosion and oxidation resistance is high at high temperatures. They are magnetic. They can be rolled hot or cold. They show their best mechanical qualities when they are normalized. Their resistance to the stress corrosion cracking caused by the chlorinated environments is high.

Weldability of ferritic chromium stainless steels is better than the weldability of martensitic stainless steels. However, one of the significant problems that occur in the welding of ferritic stainless steels is the tendency to grain growth at HAZ. This cannot be removed by a post-weld heating. Furthermore, carbide precipitation at the ferritic grain boundaries also causes vulnerability at weld joints. Thus the mechanical qualities decrease. Use of austenitic chromium-nickel electrodes at the arc welding of this type of steels with coated electrodes prevents the brittleness that is caused by the grain growth at the molten zone. GeKa ELOX R 308 L and ELOX R 347 that contain 20%Cr and 10%Ni is recommended since they have great result at welding of low-carbon ferritic stainless steels. For the ferritic stainless steels that contain more than 0.1% carbon, GeKa Flux-coated Electrodes that contain more Cr and Ni can be easily used (ELOX R 309 L).

Use of the austenitic weld metal creates weld beads that have very good mechanical qualities, and absorbs most of the welding stress. However, the color of the weld beads would be different than the base metal. GeKa ELOX B 430 coated electrode that contains 18% Cr should be used when weld beads are desired to be the same color as the base metal since filler metal that has the same characteristics as the base metal should be used.

Preheating process in the welding of stainless steels prevents the danger of cracking in HAZ and minimizes the stress that is caused by the welding. 150-300 °C preheating temperature is recommended normally. Interpass temperature can be a little higher than the preheating temperature. To keep the heat input at low temperatures, the electrode with the smallest diameter possible should be chosen, the welding speed should be high and the electrode should not oscillate.

Rapid cooling after 750-800 °C post weld heating helps the and the intergranular corrosion resistance of the HAZ to increase for this type of steels.

Cold formation of the welded joints should be done after a heating process at 300-400 °C because the deformation capability of those steels significantly increases at this temperature.

**For determination of the microstructure of the stainless steel weld metal**  
**Shaeffler Diagram**

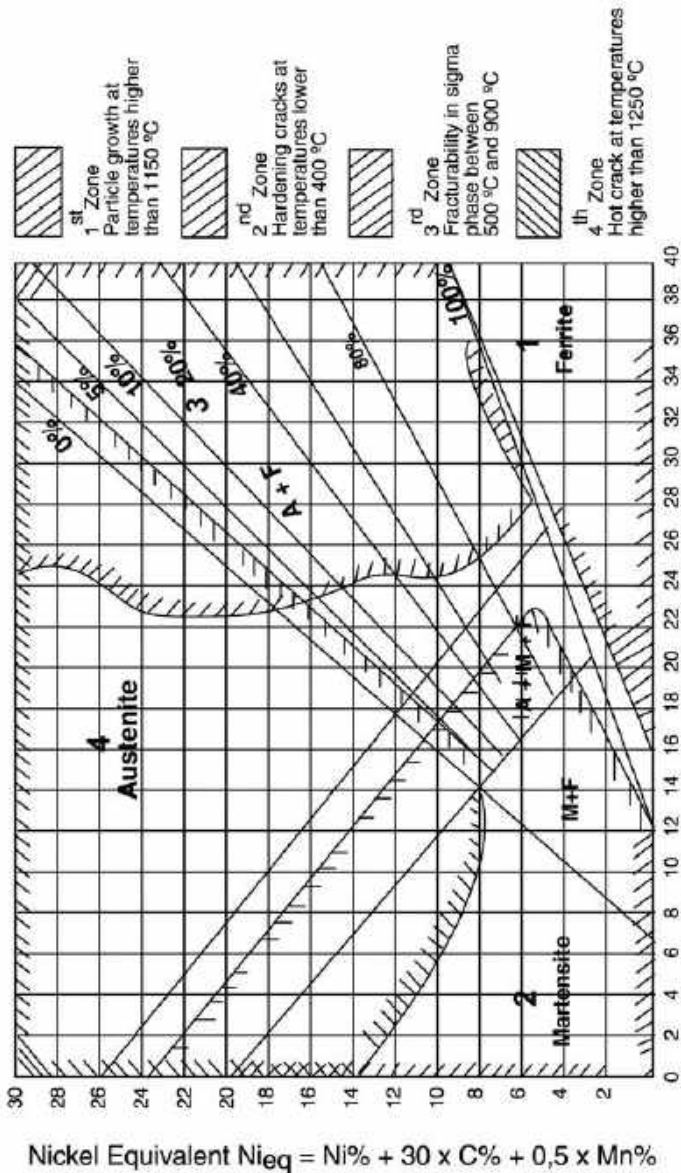

Chromium Equivalent  $C_{req} = Cr\% + Mo\% + 1,5 \times Si\% + 0,5 \times Nb\%$

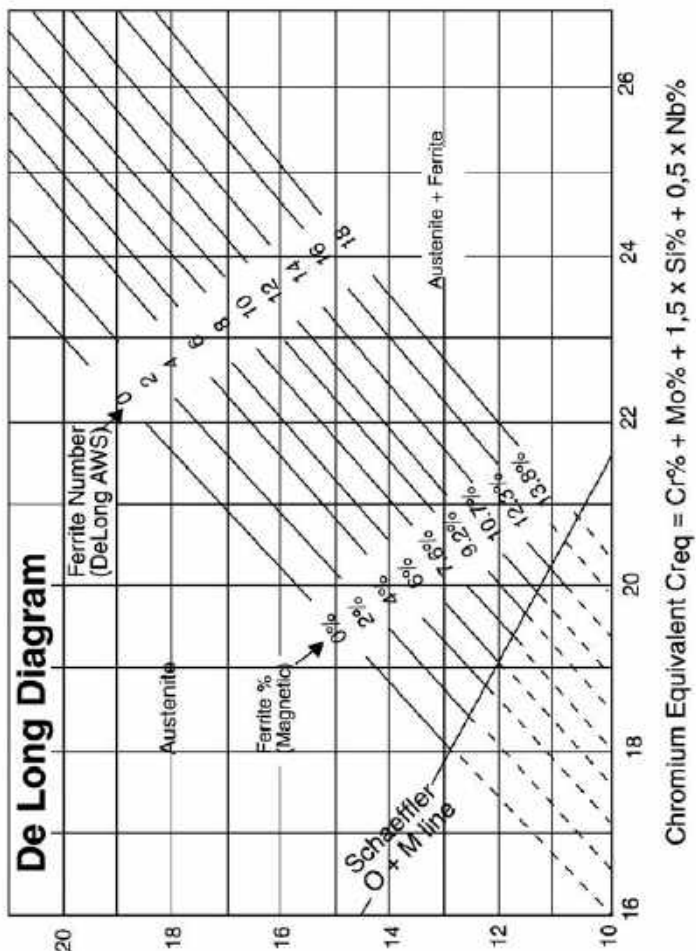

Notes: Effective Nitrogen amount shall be considered. If this amount is not known, the values below can be considered depending on the methods:

- a) MIG/TIG weld metal 0,08% (except flux-cored wires without shielding gas 0,12%)
- b) All other welding methods 0,06%

## WRC Diagram

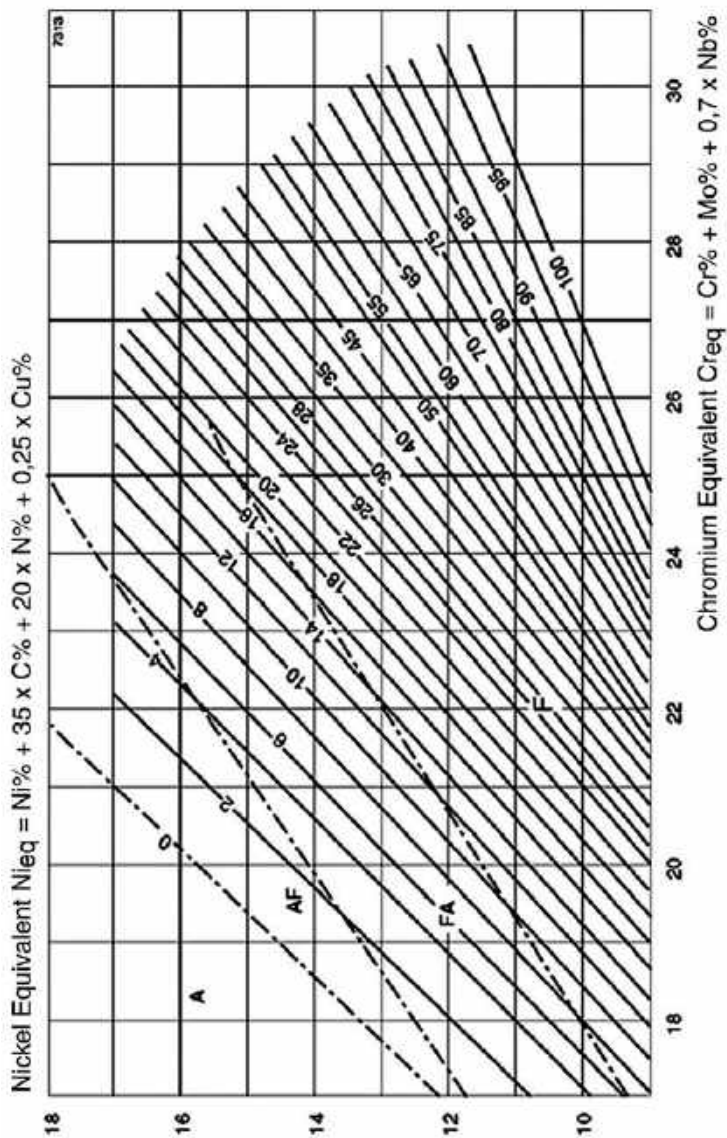



## Welding of Austenitic Chromium-Nickel Stainless Steels

The composition of austenitic chromium-nickel stainless steels contains 12-25% Cr and 8-25% Ni. Various alloy elements are added to these steels, which are antimagnetic, to increase their corrosion resistance. These stainless steels have very good weldability. However, the physical qualities they have that are mentioned before should be taken into consideration during welding. In welding of these steels, more tension is seen than the welding of low-alloy carbon steels. The possibility of hot cracks at the two-sided inside corner fillet seam of these steels is very high at the welding of these stainless steels.

SCHAEFFLER diagram and DE LONG diagram that is the advanced version of it is used while calculating the amount of ferrite in the weld metal at welding of these stainless steels. Ferrite making elements Cr, Mo, Si, and Nb are put to the horizontal axis as chromium equivalent to detect the amount of delta ferrite that will be in the composition of the weld metal with the help of these diagrams. "Ferrite numbers" and hence the ferrite percentage can be read from the De Long diagram. With the help of these diagrams, the problems that can occur in the weld metal in cases of arc welding with flux-coated electrodes are known beforehand, and the required precautions can be taken.

Another metallurgical problem in welding of austenitic chromium-nickel stainless steels is the chromium-carbide precipitation that is caused in HAZ when this zone is heated for a long time at 500-900 °C. Chromium-carbides precipitate at grain boundaries and make the steel vulnerable to intergranular corrosion. Hence, the carbon content of the austenitic chromium-nickel stainless steels that will be welded should be maximum 0.06% and, optimally, 0.03%. For this reason, it is advised that the amount of carbon of the products is decreased and the corrosion resistance is increased.

Another method to prevent the chromium-carbide precipitation is to add stabilization elements such as Ti, Nb and to the composition of the steel. Niobium is preferred in electrodes because of its deprivation in titanium arc.

GeKa product range developed has been enriched with rutile and basic-coated electrodes to be used in the arc welding of austenitic chromium-nickel stainless steels. They contain stabilization elements in their coating-fluxes. The points that are considered in case of using of basic-coated electrodes for welding of mild steels should also be considered in both arc start and welding with basic-coated electrodes in this case, too.

The lowest-diameter electrode possible should be chosen and the lowest strength amount of current should be chosen when austenitic chromium-nickel steels are arc-welded with flux-coated electrodes. The electrodes should not be oscillated. In case of multi-pass welding, the joint should be cooled down to room temperature after each pass, which should be followed by the second pass following pass should be done after that, and, then, by the application of rapid cooling should be performed. The crater that formed in the end of the weld should be filled and enclosed.

GEDIK WELDING produces flux-coated various stainless steel electrodes for welding of austenitic stainless steels. Some of them are the GeKa electrodes ELOX R 308 L, ELOX R 316 L, ELOX R 318, ELOX R 347 and ELOX R 310. In addition to these, gas-shielded (TIG or MIG) or submerged arc welding wires of GEDIK WELDING meet all your requirements. Expert staff of GEDIK WELDING is at your service in case of a problem.



## GeKa GeKaTec TIG-MIG Wires and Submerged Wire-Powder Combination for Welding of Ferritic Chromium Steels

W-No	Material Definition	ASTM AISI UNS																							
			ELOX SG 307 (TIG-MIG)	GEKA ELOX SG 308 L (TIG)	GEKA ELOX SG 308 L Si (MIG)	GEKA ELOX SG 309 L (TIG-MIG)	GEKA ELOX SG 312 (TIG-MIG)	GEKA ELOX SG 316 L Si (MIG)	GEKA ELOX SG 316 L (TIG)	ELOX SG 347 (TIG)	ELOX SG 347 Si (MIG)	ELOX SG 318 (TIG)	ELOX SG 318 Si (MIG)	GEKA ELOX SG 430 (MIG)	GEKATEK 430 (MIG)	GEKATEK 430 LNB SG	GEKATEK 308 L Si (MIG)	GEKATEK 308 L (TIG)	GEKATEK 316 L Si (MIG)	GEKATEK 316 L (TIG)	GEKATEK 7016 SG	GEKA ELOX UP 308 L / ELIFLUX BSS	GEKA ELOX UP 316 L / ELIFLUX BSS		
1.4000	X6Cr13	403	○	○	○	○	○																		
1.4001	X7Cr14	429	○	○	○	○	○																		
1.4001	G-X7Cr14		○	○	○	○	○																		
1.4002	X6CrAl13	405	○	○	○	○	○																		
1.4003	X2CrNi12		○	○	○	○	○																		
1.4006	X12Cr13	410	○	○	○	○	○																		
1.4008	GX8CrNi13	CA 15	○	○	○	○	○																		
1.4016	X6Cr17	430	○	○	○	○	○																		
1.4021	X70Cr13	420	○	○	○	○	○																		
1.4024	X15Cr13	410	○	○	○	○	○																		
1.4027	GX20Cr14	A 217	○	○	○	○	○																		
1.4034	X46Cr13		○	○	○	○	○																		
1.4034	G-X46Cr13	420	○	○	○	○	○																		
1.4057	X17CrNi19-2	431	○	○	○	○	○																		
1.4059	GX22CrNi17	A 743	○	○	○	○	○																		
1.4113	X6CrMo17-1	434	○	○	○	○	○																		
1.4120	X20CrMo13		○	○	○	○	○																		
1.4120	GX20CrMo13		○	○	○	○	○																		
1.4122	X39CrMo17-1		○	○	○	○	○																		
1.4122	GX35CrMo17-1		○	○	○	○	○																		

**Prod. Groups**
 GEKA TIG-MIG WIRE

 GEKATEK TIG-MIG WIRE

 GeKa Submerged Wire-Powder Combination

**Explanations**

Substance and the additional metal have the same properties



Additional metals have higher alloys than the substance

## GeKa GeKaTec Electrodes for Welding of Chemical Resistant Steels

W-No	Material Definition	ASTM AISI UNS	Product Groups															
			ELOX R 317 L	ELOX B 410 NiMo	ELOX B 410	ELOX BS 410 NiMo	ELOX B 305 / ELOX R 305	ELOX B 2209 / ELOX R 2209	ELOX B 308 L / ELOX R 308 L	ELOX R 316 L / ELOX B 316 L	ELOX B 347 / ELOX R 347	ELOXR 318 / ELOX B 318	ELOX B 430	NIBAZ B 65	GK 410 HD	GK 308 L	GK 316 L	GK ANTI-CRACK 70 15
1.3932	X2CrNiMoN18-14-3																	
1.3964	X2CrNiMoNi21-16-5-3	520910																
1.4301	X5CrNi18-10	304																
1.4303	X4CrNi18-12	305																
1.4306	X2CrNi19-11	304L																
1.4308	GX5CrNi19-10																	
1.4311	X2CrNi18-10	304LN																
1.4312	GX10CrNi18-8																	
1.4313	X3CrNiMo13-4	541500																
1.4317	G-X 4CrNi 19-4																	
1.4361	X1CrNiSi18-15-4																	
1.4401	X5CrNiMo17-12-2	316																
1.4404	X2CrNiMo17-12-2	316 L																
1.4406	X2CrNiMo17-11-2	316 L																
1.4407	G-X5CrNiMo13-4	CAGNM																
1.4408	G-X5CrNiMo18-11-2																	
1.4409	GX2CrNiMo10-11-2																	
1.4429	X2CrNiMo17-13-3	316LN																
1.4435	X3CrNiMo18-14-13	317L																
1.4436	X3CrNiMo17-13-5	531600																
1.4457	GX5CrNiMo18-12	531600																
1.4438	X2CrNiMo18-15-4	531703																
1.4439	X2CrNiMo17-13-6	531726																
1.4446	GX2CrNiMoN17-13-4																	
1.4448	GX3CrNiNi17-3																	
1.4452	X2CrNiMoA22-5-3	531803																
1.4500	GX7NiCrTiMoCuNb25-20																	
1.4505	X4NiCrMoCuNb20-18-2																	
1.4506	X3CrNiMoCuTi20-18																	
1.4510	X3CrTi17	430 Ti																
1.4511	X3CrNi17	430 Cr																
1.4512	X2CrTi12	540900																
1.4529	X1NiCrMoCuNi25-20-7	N09925																
1.4531	GX2NiCrMoCuNi20-18																	
1.4530	GX2NiCrMoCuNi25-20																	
1.4539	X1NiCrMoCu25-20-5	N09904																
1.4541	A8CrNiTi18-10	321																
1.4560	X8CrNiNb18-10	347																
1.4562	GX5CrNiNb19-11	CFBC																
1.4566	X2NiCrAlTi32-20	8407																
1.4571	X3CrNiMoTi17-12-2	316 Ti																
1.4577	X3CrNiMoTi25-25	531640																
1.4580	X8CrNiMoNb17-12-2	315 Cr																
1.4581	GX5CrNiMoNb19-11-2																	
1.4583	X10CrNiMoNb18-12	315 Cr																
1.4585	GX7CrNiMoCuNi18-10																	
1.4586	X5NiCrMoCuNb22-18	N09925																
2.4856	NiCr21Mo9Nb	N09825																
2.4858	NiCr21Mo	N09825																

Product Groups  GEKA  GEKATEC

### Explanations

 Substance and the additional metal have the same properties

 Additional metals have higher alloys than the substance

## GeKa GeKaTec TIG-MIG Wires and Submerged Wire-Powder Combination for Welding of Chemical Resistant Steels

W-No	Material Definition	ASTM AISI UNS	GEKA ELOX SG 308 L Si (MIG)		GEKA ELOX SG 308 L (MIG)		ELOX SG 347 (TIG)		ELOX SG 347 Si (MIG)		GEKA ELOX SG 316 L Si (MIG)		GEKA ELOX SG 316 L (MIG)		ELOX SG 318 (TIG)		ELOX SG 318 Si (MIG)		ELOX SG 430 (MIG)		GEKATEK 308 L Si (MIG)		GEKATEK 308 L (MIG)		GEKATEK 316 L Si (MIG)		GEKATEK 316 L (MIG)		GEKATEK 7015 SG		GEKA ELOX UP 308 L / ELFLUX BSS		GEKA ELOX UP 316 L / ELFLUX BSS		
			●	○	●	○	●	○	●	○	●	○	●	○	●	○	●	○	●	○	●	○	●	○	●	○	●	○	●	○	●	○	●	○	
1.4301	X5CrNi18-10	304	●	○	●	○	○	○	○	○	○	○	○	○	○	○	○	○	○	○	○	○	○	○	○	○	○	○	○	○	○	○	○		
1.4303	X4CrNi18-12	305	●	○	●	○	○	○	○	○	○	○	○	○	○	○	○	○	○	○	○	○	○	○	○	○	○	○	○	○	○	○	○	○	
1.4308	X2CrNi19-11	304L	●	○	●	○	○	○	○	○	○	○	○	○	○	○	○	○	○	○	○	○	○	○	○	○	○	○	○	○	○	○	○	○	
1.4308	GX5CrNi19-10		●	○	●	○	○	○	○	○	○	○	○	○	○	○	○	○	○	○	○	○	○	○	○	○	○	○	○	○	○	○	○	○	
1.4311	X2CrNiN18-10	304LN	●	○	●	○	○	○	○	○	○	○	○	○	○	○	○	○	○	○	○	○	○	○	○	○	○	○	○	○	○	○	○	○	
1.4312	GX10CrNi18-8		●	○	●	○	○	○	○	○	○	○	○	○	○	○	○	○	○	○	○	○	○	○	○	○	○	○	○	○	○	○	○	○	
1.4401	X5CrNiMo17-12-2	315	●	○	●	○	○	○	○	○	○	○	○	○	○	○	○	○	○	○	○	○	○	○	○	○	○	○	○	○	○	○	○	○	
1.4404	X2CrNiMo17-12-2	316 L	●	○	●	○	○	○	○	○	○	○	○	○	○	○	○	○	○	○	○	○	○	○	○	○	○	○	○	○	○	○	○	○	
1.4405	X2CrNiMoN17-11-2	316 L	●	○	●	○	○	○	○	○	○	○	○	○	○	○	○	○	○	○	○	○	○	○	○	○	○	○	○	○	○	○	○	○	
1.4407	G-X5CrNiMo13-4	CA6NM	●	○	●	○	○	○	○	○	○	○	○	○	○	○	○	○	○	○	○	○	○	○	○	○	○	○	○	○	○	○	○	○	
1.4408	G-X5CrNiMo19-11-2		●	○	●	○	○	○	○	○	○	○	○	○	○	○	○	○	○	○	○	○	○	○	○	○	○	○	○	○	○	○	○	○	
1.4409	GX2CrNiMo19-11-2		●	○	●	○	○	○	○	○	○	○	○	○	○	○	○	○	○	○	○	○	○	○	○	○	○	○	○	○	○	○	○	○	
1.4429	X2CrNiMoN17-13-3	315LN	●	○	●	○	○	○	○	○	○	○	○	○	○	○	○	○	○	○	○	○	○	○	○	○	○	○	○	○	○	○	○	○	○
1.4435	X2CrNiMo18-14-13	317L	●	○	●	○	○	○	○	○	○	○	○	○	○	○	○	○	○	○	○	○	○	○	○	○	○	○	○	○	○	○	○	○	○
1.4436	X3CrNiMo17-13-3	S31600	●	○	●	○	○	○	○	○	○	○	○	○	○	○	○	○	○	○	○	○	○	○	○	○	○	○	○	○	○	○	○	○	○
1.4437	GX6CrNiMo18-12	S31600	●	○	●	○	○	○	○	○	○	○	○	○	○	○	○	○	○	○	○	○	○	○	○	○	○	○	○	○	○	○	○	○	○
1.4510	X3CrTi17	430 Ti	○	○	○	○	○	○	○	○	○	○	○	○	○	○	○	○	○	○	○	○	○	○	○	○	○	○	○	○	○	○	○	○	○
1.4511	X3CrNb17	430 Cb	○	○	○	○	○	○	○	○	○	○	○	○	○	○	○	○	○	○	○	○	○	○	○	○	○	○	○	○	○	○	○	○	○
1.4512	X2CrTi12	S40900	○	○	○	○	○	○	○	○	○	○	○	○	○	○	○	○	○	○	○	○	○	○	○	○	○	○	○	○	○	○	○	○	○
1.4529	X1NiCrMoCuN25-20-7	N08925	○	○	○	○	○	○	○	○	○	○	○	○	○	○	○	○	○	○	○	○	○	○	○	○	○	○	○	○	○	○	○	○	○
1.4536	GX2NiCrMoCuN25-20		○	○	○	○	○	○	○	○	○	○	○	○	○	○	○	○	○	○	○	○	○	○	○	○	○	○	○	○	○	○	○	○	○
1.4539	X1NiCrMoCu25-20-5	N08904	○	○	○	○	○	○	○	○	○	○	○	○	○	○	○	○	○	○	○	○	○	○	○	○	○	○	○	○	○	○	○	○	○
1.4541	X6CrNiTi18-10	321	○	○	○	○	○	○	○	○	○	○	○	○	○	○	○	○	○	○	○	○	○	○	○	○	○	○	○	○	○	○	○	○	○
1.4550	X6CrNiNb18-10	347	○	○	○	○	○	○	○	○	○	○	○	○	○	○	○	○	○	○	○	○	○	○	○	○	○	○	○	○	○	○	○	○	○
1.4552	GX5CrNiNb19-11	CF8C	○	○	○	○	○	○	○	○	○	○	○	○	○	○	○	○	○	○	○	○	○	○	○	○	○	○	○	○	○	○	○	○	○
1.4555	X2NiCrAlTi32-20	B407	○	○	○	○	○	○	○	○	○	○	○	○	○	○	○	○	○	○	○	○	○	○	○	○	○	○	○	○	○	○	○	○	○
1.4571	X6CrNiMoTi17-12-2	316 Ti	○	○	○	○	○	○	○	○	○	○	○	○	○	○	○	○	○	○	○	○	○	○	○	○	○	○	○	○	○	○	○	○	○
1.4577	X3CrNiMoTi25-25	S31540	○	○	○	○	○	○	○	○	○	○	○	○	○	○	○	○	○	○	○	○	○	○	○	○	○	○	○	○	○	○	○	○	○
1.4580	X6CrNiMoNb17-12-2	316 Cb	○	○	○	○	○	○	○	○	○	○	○	○	○	○	○	○	○	○	○	○	○	○	○	○	○	○	○	○	○	○	○	○	○
1.4591	GX5CrNiMoNb19-11-2		○	○	○	○	○	○	○	○	○	○	○	○	○	○	○	○	○	○	○	○	○	○	○	○	○	○	○	○	○	○	○	○	○
1.4583	X10CrNiMoNb18-12	316 Cb	○	○	○	○	○	○	○	○	○	○	○	○	○	○	○	○	○	○	○	○	○	○	○	○	○	○	○	○	○	○	○	○	○
2.4856	NiCr22Mo6Nb	N06625	○	○	○	○	○	○	○	○	○	○	○	○	○	○	○	○	○	○	○	○	○	○	○	○	○	○	○	○	○	○	○	○	○
2.4858	NiCr21Mo	N08825	○	○	○	○	○	○	○	○	○	○	○	○	○	○	○	○	○	○	○	○	○	○	○	○	○	○	○	○	○	○	○	○	○

Product Groups  GeKa TIG MIG Wire  GeKaTec TIG MIG Wire  GeKa Submerged Wire-Powder Combination

Explanations  Substance and the additional metal have the same properties

Additional metals have higher alloys than the substance

## GeKa GeKaTec Branded Electrodes and TIG-MIG Wires for Welding of Heat Resisting Steels

Material Definition	W-No	ASTM AISI UNS	Service Temperature °C	ELOX B 327	ELOX B 309	ELOX B 310	ELOX B 347	ELOX R 307	NIBAS B 70	GEKATEK 309 Mo	GK 310	GK UNIBASE 660 HD	GK ANTIRACK 7015	ELOX SG 310 (TiG-MIG)	ELOX SG 307 (TiG-MIG)	GEKA ELOX SG 308 L (TiG-MIG)	GEKATEK 309 L (TiG)	GEKATEK 7015 SG
Heat resisting steels	1.4710		850	●	○	○	○	○	○	○	○	○	○	○	○	○	○	○
	1.4712		850	○	○	○	○	○	○	○	○	○	○	○	○	○	○	○
	1.4713		850	○	○	○	○	○	○	○	○	○	○	○	○	○	○	○
	1.4724	405	850	○	○	○	○	○	○	○	○	○	○	○	○	○	○	○
	1.4729	905	900	○	○	○	○	○	○	○	○	○	○	○	○	○	○	○
	1.4760	960	960	○	○	○	○	○	○	○	○	○	○	○	○	○	○	○
	1.4742	630	1050	○	○	○	○	○	○	○	○	○	○	○	○	○	○	○
	1.4745		1050	○	○	○	○	○	○	○	○	○	○	○	○	○	○	○
	1.4762	446	1200	○	○	○	○	○	○	○	○	○	○	○	○	○	○	○
	1.4821	327	1100	○	○	○	○	○	○	○	○	○	○	○	○	○	○	○
	1.4822		1100	○	○	○	○	○	○	○	○	○	○	○	○	○	○	○
	1.4825	A 287, Gr. CF20	800	○	○	○	○	○	○	○	○	○	○	○	○	○	○	○
	1.4836	A 287, Gr. HF	960	○	○	○	○	○	○	○	○	○	○	○	○	○	○	○
	1.4828	509	1050	○	○	○	○	○	○	○	○	○	○	○	○	○	○	○
	1.4832		1000	○	○	○	○	○	○	○	○	○	○	○	○	○	○	○
	1.4837	A 287, Gr. HH	1150	○	○	○	○	○	○	○	○	○	○	○	○	○	○	○
	1.4841	314, 310	1150	○	○	○	○	○	○	○	○	○	○	○	○	○	○	○
	1.4846	310	1050	○	○	○	○	○	○	○	○	○	○	○	○	○	○	○
	1.4861		1200	○	○	○	○	○	○	○	○	○	○	○	○	○	○	○
	1.4854	350	1100	○	○	○	○	○	○	○	○	○	○	○	○	○	○	○
	1.4855	350	1120	○	○	○	○	○	○	○	○	○	○	○	○	○	○	○
	1.4876	B153	1150	○	○	○	○	○	○	○	○	○	○	○	○	○	○	○
	1.4878	321	600	○	○	○	○	○	○	○	○	○	○	○	○	○	○	○
	1.6559		600	○	○	○	○	○	○	○	○	○	○	○	○	○	○	○

**Product Groups**

**GEKA**

**GEKATEK**
**Explanations**

Substance and the additional metal have the same properties

Additional metals have higher alloys than the substance

## Welding of High-Manganese Austenitic Hard Steels

High-manganese austenitic steels that are named as Haldfield steel in Anglo-Saxon literature, and are widely used in contemporary technology are tough, ductile, durable, abrasion resisting, antimagnetic materials that have high strain hardening, and contain 11-14% Mn and 0.7-1.4 % C. Cr, Mo, V, Cu, Ti and Ba is added as the alloy element to these steels in order to acquire some additional qualities.

These steels are used in the production of the joints that take impact and are worn out of the heavy construction equipments such as excavator buckets, baggers, grader and dozer blades, crusher jaws.

High-manganese austenitic hard steels can easily be welded because of their austenitic structure although their thermal conductivity is very low and their thermal expansion is high. They become brittle because of carbide formation when they stay at 400-800 °C temperature for a long time, and their tendency to crack increases. Thus, these steels are welded only with electrical arc welding by applying as little heat input as possible. Each pass is cooled down by spraying water or wiping with a wet cloth after welding. Big pieces are welded by putting them into a water bath in such a way that only the weld zone is out of water.

Distortions and deformations in welding of the manganese austenitic hard steels are severer than the welding of carbon steels because of their high thermal expansion and low thermal conductivity. Even though cooling process decreases the severity of this problem, hammering the weld bead after cooling is very useful both for reducing the internal stress and for increasing the abrasion resistance as a result of deformation hardening.

### Build-Up

Making worn out machine parts usable with build-up is very economical. As the types of electrodes increased, it is no longer necessary to use an electrode that is made up of the same material as the material of the joint that will be repaired. There is a possibility of applying filler welding with a material that is much more durable.

Before the filler welding of a worn out joint, surfaces that will be filled should be processed until all the abrasion cracks are removed with grinding or machining. If base metal and electrode are made up of different materials, using ELOX B 307 electrode that is ductile, that can remove the post welding internal stresses by changing its shape, and, that can prevent the fusion zone that can have undesired characteristics as the buffer layer is recommended. Filling processed is applied with ELHARD 14 Mn electrode by cooling and hammering each pass on the buffer layer made up

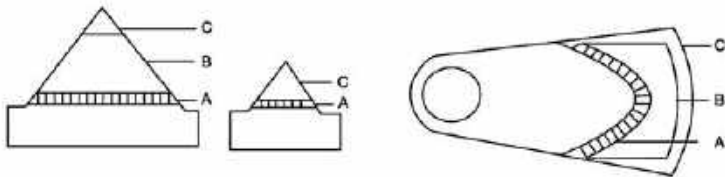

A - Buffer Welding with ELOX B 307  
 B - Build-Up with ELHARD 14 Mn  
 C - Hardfacing with ELHARD 600

It would be safer if the last three passes are built up with ELHARD 600 in order for build-up layer to be more abrasion and impact resisting.

If the joints are small and lightly abraded, ELHARD 600 can be directly used on top of the buffer layer that is made with ELOX B 307. To have a more effective outcome in breaker and crusher jaws, the pass that is made with ELHARD 600 should be hot hammered. Although cooling the hot weld bead by putting it in water is also recommended to increase hardness, this process can only be applied to small joints that have a small filling zone.

If the top layer has to be very hard, ELHARD 60/63/65 can be used instead of ELHARD 600. However, this type of electrodes should not be applied in more than two passes in filling processes, and cooling and hammering processes should not be applied to them.

### Joint Welding

Manganese austenitic hard steels can be welded with the same steels or with low-alloy steels. Chromium-nickel-manganese alloyed ELOX B 307 should be preferred instead of a high-manganese electrode that fits the composition of the base metal for this process. This electrode has an excellent abrasion resistance and removes tensions by changing its shape with its high ductility. Welding process should be made by applying as little heat input as possible and a cooling process. Short passes should be applied by changing directions, and each pass should be hammered after it cooled down.

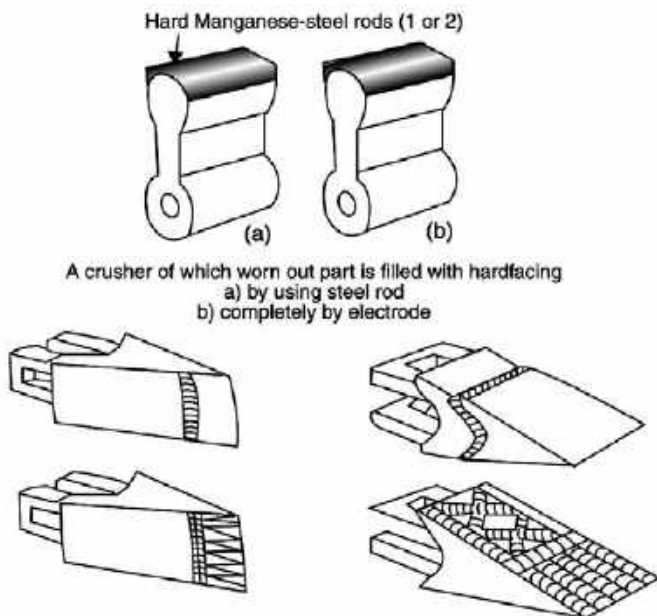

Hardfacing application in repair and maintenance of bucket teeth that are made up of manganese austenitic hard steel.



## Welding of Cast Irons

Cast irons are iron alloys that generally contain 1.7-4% C, 3.5% Si, Mn, S, and P. The facts that cast irons can flow well when they are liquid, their melting point is low, they are not affected by carbon catching during melting made them unique cast material. Cast irons contain carbon in unbound form, in carbide and a little in ferrite. The type and the characteristics of cast irons are determined by the form of the carbon. The significant types of cast irons for welding that are highly used in industry are gray cast iron and nodular cast iron.

## Welding of Gray Cast Irons

Gray cast iron has an internal structure that is composed of unbound graphite that is scattered in the form of platelets in a matrix that resembles low-alloy unbound-carbon steels. The reason for the gray cast iron not to have transformation capability, to have low strength and to be brittle is the graphite platelets in its internal structure.

Two significant points affect the weldability of gray cast iron;

- 1- Since the melted zone rapidly cools down because of its high carbon content, weld bead is very hard, brittle and rich in cementite.
- 2- Deformation caused by regional heating and cooling during welding causes the cast iron joint that is very brittle to crack from the weakest point.

There are two solutions for the welding of cast iron.

- It is possible to prevent both the hard structure that is caused by rapid cooling and the danger of cracking caused by welding stress by applying preheating at a very high temperature (600-700 °C). Electric arc welding and oxi-acetylene welding with a metal that has the suitable composition to the base metal can be applied in this process, which can be named as hot welding.
- The bases of the welding process of gray casting irons that is named as cold welding is to apply heat low enough to prevent the formation of high amounts of cementite and martensite and formation of the stress that can cause fracture in the course of heating, and, to use a weld metal that does not cause martensite and cementite formation. Pure Nickel, Copper-Nickel, Iron-Nickel alloy coated electrodes are used in this method.

V, X and U grooves in 80-90° angle is applied to joint that will be welded. Cast spunk along the grooves is cleaned. It is necessary to obey the following conditions in this welding method during welding to prevent the danger of heat stress cracking, to narrow transition zone and to decrease the hardening in this zone.

Heat input should be decreased by using the thinnest electrode and the lowest strength of current possible.

Weld bead length should be limited to 25mm in order for the base metal not to warm too much.

Each pass should be hammered with a round head hammer before it cools down to decrease the stress the weld metal causes by shrinking.

Welding should be paused after each weld bead until the joint cools down to a temperature at which one can touch it by hand.

Electrode should be started on the prior seam when welder starts a new seam.

Arc should always be directed to the piled metal during welding and welder should go back a little while they put out the arc. They should retract the electrode slowly.

In order to decrease the stresses in the multi pass welding of thick joints, welding should be applied in width and length.

Geka developed pure nickel ELNIKEL, copper-nickel ELMONEL and ferronickel ELNIFER electrodes for the cold welding of cast irons.

It is possible to apply the weld joint quicker, with less risk and with longer seams using electrodes above and a preheating at 150-250 °C in the cases where the size, shape and the type of the cast iron joint are appropriate. In the method that is called half-hot welding, the hardness of the HAZ does not exceed 200 Vickers.

In the cases where the weld zone does not have to be processed, an experienced welder can get a satisfactory result with LASER B 50 or ELFER basic electrodes if they obey the conditions above. However, hard zones that can exceed 450 Vickers can be seen in the HAZ in these conditions.

### Welding of Nodular Cast Irons

Long studies showed that ferronickel based electrode ELNIFER is the most appropriate electrode for the welding of nodular cast iron. Although nodular cast irons can be welded with low heat input, the most appropriate results are gotten in the applications

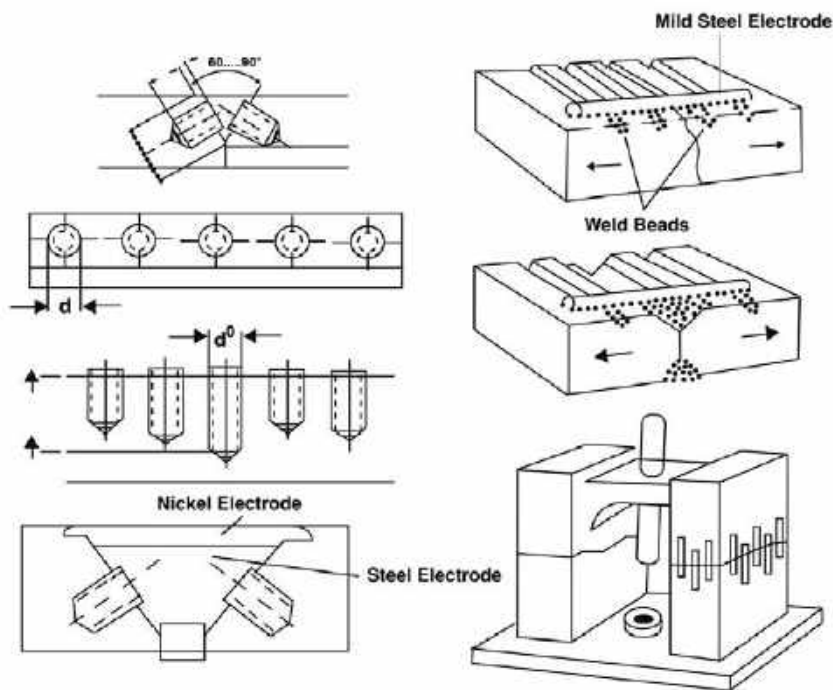

Examples of reinforced stud welding of cast iron joints

## Welding Positions according to EN and AWS Standards

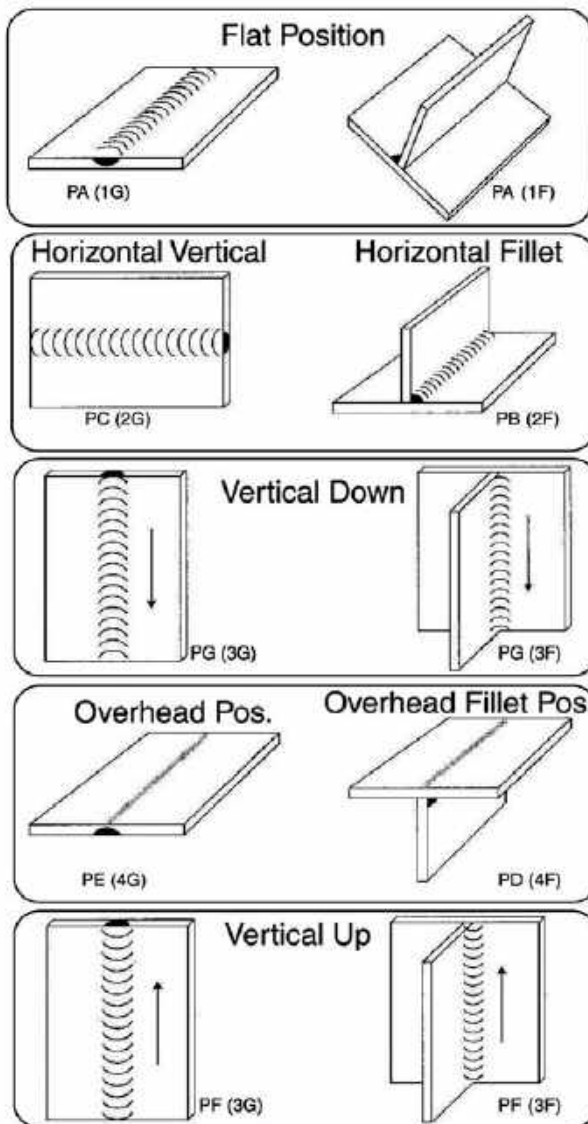

## Symbols for the Designation of Weld Beads in Projects

Usage of welding symbols and supporting elements adopted and standardized to make graphing and reapplication of welded constructions easier. TS 3004 is published on this issue in Turkey. However, conductors do not completely obey this standard. Thus, our craftsmen should be knowledgeable.

Illustrations that are the most important part of the welding plan should reflect all properties of weld beads.

There are an elementary symbol, an arrow line that has an arrow that shows the joint at the end of it, and a reference line in illustrations

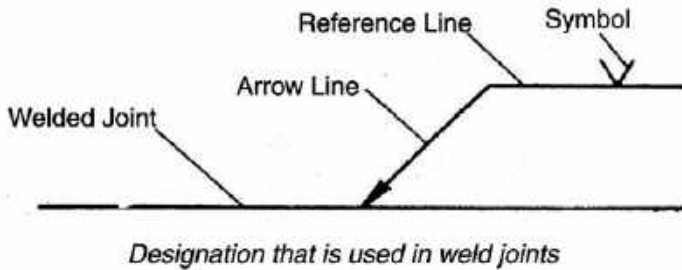

The side of the joint where the arrow put is called "arrow side of the joint", the other side is called "other side of the joint".

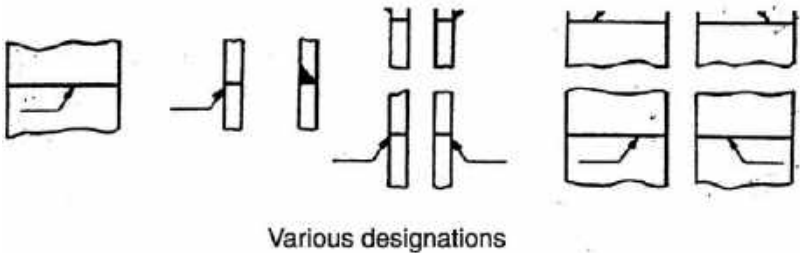

The position of the arrow line with respect to the weld is generally of no special significance. However, the arrow line should point towards the plate which is prepared for welding.







The reference line should be drawn parallel to the bottom edge of the drawing,

Positions of the symbols in relation to the reference line are defined according to E (first angle) and A (third angle) methods.

One should look into TS 3004 if they have to graph or read welding construction illustrations that are graphed using A method.

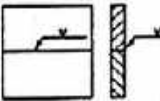

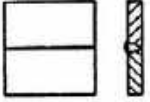
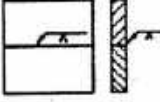

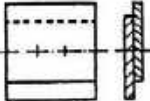
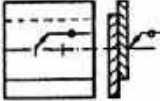









































































Although the symbols that are used in the illustrations of welded constructions have some differences depending on the symbols of the countries, they can show the information that determine the construction such as groove and seam surface from easily, clearly and in a simple way.

### Position of the symbols according to E Method









Illustration	Figure	Figure Position of the symbols	Definition of Position of the symbols
			The symbol is placed above the reference line if the weld face is on the arrow side of the joint
			If the exterior surface of the weld is on the other side of the joint, below the reference line
			If welding is not made in the junction plane, on the reference line

Note: In the case of spot welds made by projection welding, the projection surface is to be considered as the external surface of the weld.





## Notation of Elementary Symbols in Standards

Designation	Illustration	Symbol			
		TS	DIN	AWS	BS
Butt weld between plates with raised edges					
Butt weld between plates with raised edge					
Square butt weld					
Single-V butt weld					
Convolute Single-V butt weld					
Single-bevel butt weld					
Single-V butt weld with broad root face					
Single-bevel butt weld with broad root face					
Single-U butt weld					
Single-J butt weld					
Backing weld					
Fillet weld					
Plug weld					
Spot weld					
Seam weld					
Steep-flanked single-V butt weld					
Steep-flanked single-bevel butt weld					
Edge weld					
Surfacing					









## Examples of Elementary Symbols in a Combined Way

Designation	Illustration	Symbol			
		TS	DIN	AWS	BS
Double-V butt weld (X weld)		X	X	X	X
Double-bevel butt weld		K	K	K	K
Double-V butt weld with broad root face		Y	Y	Y	Y
Double-bevel butt weld with broad root face		K	K	K	K
Double-U butt weld		Y	Y	Y	Y
Double-J butt weld		K	K	K	K
V-U Butt weld		Y	Y	Y	Y
Single-V butt weld with broad root face and backing run		Y	Y	Y	Y
Double-Fillet weld		▷	▷	▷	▷

### Supplementary symbols

Shape of the welded surface	Symbol
Flat	
Convex	
Concave	
Toes shall be blended smoothly	

## Position of the symbols according to E Method

Illustration	figure	Position of the symbols	Definition of Position of the symbols
			If the exterior surface of the weld is on the arrow side of the joint, above the reference line
			If the exterior surface of the weld is on the other side of the joint, below the reference line
			If welding is not made in the junction plane, on the reference line

Note: In the case of spot welds made by projection welding, the projection surface is to be considered as the external surface of the weld.

Weld symbols are generally examined under three groups:

- Elementary Symbols
- Combined Symbols
- Supplementary symbols

We can look at the notation of these in various country symbols.

### a) Elementary Symbols









Examples for the usage of elementary symbols to show the welding type are also given in the table. These symbols are generally similar to the shape of the weld seam. Hence they can be easily remembered.

### b) Combined Symbols

These symbols are shown in the table for the examples of elementary symbols in a combined way.

### c) Supplementary Symbols

Elementary symbols can be completed with the supplementary symbols that show the shape of surface of the weld seam. Welded surfaces are generally made flat. Since there is no need to show the welding surface completely, it is normal that supplementary symbols are not used.

Designation	Illustration	Symbol
Flat single-V butt weld		
Convex double-V weld		
Concave fillet weld		
Flat single-V butt weld with flat backing run		

*Examples of application of supplementary symbols*



Certain dimensions can be shown next to each welding symbol.

The main dimension of the cross section should be written on the left side of the symbol. Lengthwise dimensions ((Length of the weld bead) should be written on the right side of it.

The principles for these dimensions are shown in the table. More significant dimensions can be shown when necessary.

In case of flat weld joints, it is understood that welding is made without opening a root along the joint.

## Basic Dimensions

<b>No</b>	<b>Welding Method</b>
1	Arc welding
11	Metal-arc welding without gas protection
111	Metal-arc welding with coated electrode
12	Submerged arc welding
13	Gas-shielded metal-arc welding
131	MIG welding
135	MAG welding
141	TIG welding
15	Plasma arc welding
2	Resistance welding
21	Spot welding
22	Seam welding
23	Projection welding
24	Flash welding
3	Gaswelding
311	Oxy-acetylene welding
4	Pressure welding
41	Ultrasonic welding
42	Friction welding
441	Explosive welding
45	Diffusion welding
71	Thermic welding
72	Electro-slag welding
73	Electro-gas welding
751	Laser beam welding
76	Electron beam welding
9	Brazing, soldering and braze welding

According to DiN 1912, assessment group of the welding is shown right after the welding method in between slashes.

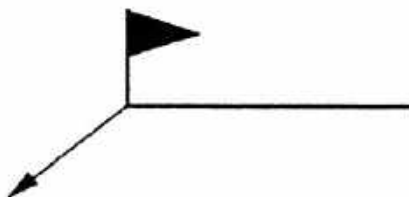

Flag symbol that is used to indicate the field or site weld

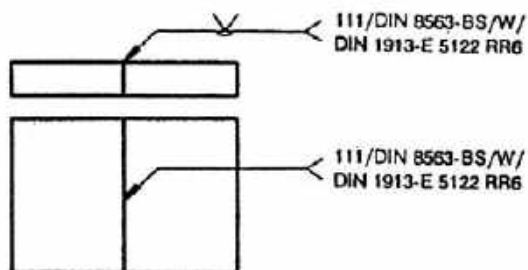

Welding position and the designation of the electrode that is used

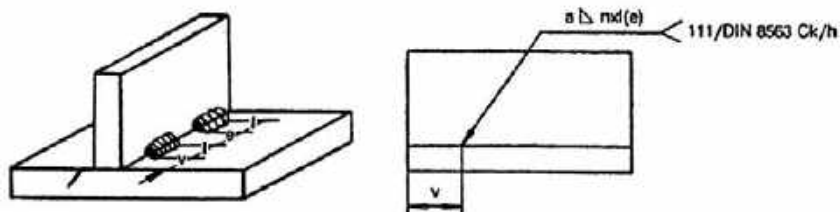

An example of an intermittent fillet weld

## ELECTRODE CONSUMPTION CALCULATION

In order to calculate the welding cost, the amount of electrodes that will be used should be calculated since it is the most important input. Although there are computer programs for this purpose, this can also be approximately calculated with the eight tables that are given below. In the first seven of these tables, the diameters of the electrodes that are recommended are also given considering the plate thickness and the weight of 1 meter welding seam and the welding position in fillet welds. The number of electrodes that are needed is calculated for root and filler passes from table 8 in relation to the electrode diameter and length with the help of 1 meter seam weight that is calculated from those tables. The discarded stem length is considered to be 30mm and the loss that is caused by spattering and burning is considered to be 10% in this table. This value changes between 87% and 93% in practice depending on the type of electrode and the strength of current.

Since the efficiency of electrodes that have iron powder is higher the number of electrodes that are used in practice is lower than the number that is determined according to the table. Hence the number that is calculated with the help of the table is multiplied with 0.8 for 100-120 % efficiency electrodes and 0.6 for 160% efficiency electrodes.

**Example 1:** Calculation of the required number of electrodes for 1 meter welding seam when a 6mm plate is welded with a V groove in a horizontal position.

The weight of 1 meter welding seam is calculated as 0.10kg when 350mm long electrode that has 3.25mm long diameter is used for root pass according to table 1.

The weight of 1 meter welding seam is calculated as 0.12kg when 350mm long electrode that has 4mm long diameter is used for filler pass.

The number of electrodes according to table 8.  $0.10\text{kg} = 5.3$  ( $\emptyset 3.25 \times 350\text{mm}$  electrodes)

$0.12\text{kg} = 0.10 + 0.02\text{kg} = 3.5 + 0.7 = 4.2$  ( $\emptyset 4.00 \times 350\text{mm}$  electrodes)

**Example 2:** Calculation of the required number of electrodes when a 16mm plate is welded with a V groove and its root is also welded from underside in a horizontal position.

The weight of 1 meter welding seam is calculated as 0.12kg when 450mm long electrode that has 4mm long diameter is used for root pass according to table 1.

In case of a root pass underside, 1 meter welding seam is calculated as 0.12kg for 450mm long electrode that has 4mm long diameter.

The weight of 1 meter welding seam is calculated as 1.3kg when 450mm long electrode that has 5mm long diameter is used for filler pass.

The number of electrodes according to table 8.

**Root pass:**  $0.12 = 0.10 + 0.02 = 2.7 + 0.5 = 3.2$  ( $\emptyset 4.00 \times 450\text{mm}$  electrodes)

**Underside Root Pass:**  $0.12 = 0.10 + 0.02 = 2.7 + 0.5 = 3.2$  ( $\emptyset 4.00 \times 450\text{mm}$  electrodes)

**Filler Pass:**  $1.3 = 1 + 0.3 = 17.2 + 5.2 = 22.4$  ( $\emptyset 5.00 \times 450\text{mm}$  electrodes)

**Note:** These calculations are for normal electrodes. For example, if the same welding process is made with a 160% efficient iron powder coated electrode, the number should be multiplied with 0.6. In case of basic electrodes, it should be multiplied with 0.8.

## Weld Bead Weight in V groove in horizontal and flat positions

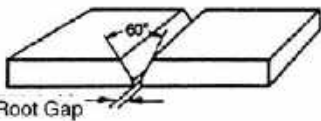
<b>V-Groove</b> Horizontal and flat position Groove angle: 60°				
				
Plate Thickness (mm)	Root Gap (mm)	Electrode Diameter (mm)	Approximate Seam Cross-Section (mm)	Seam Weight (kg/m)
3	1	2,5	8,5	0,07
4	1	2,5 or 3,25	13,5	0,11
5	1	3,25	19,5	0,16
6	1	W 3,25 D 4	27	0,10 0,12
7	1,5	W 3,25 D 4	39	0,10 0,21
8	1,5	W 3,25 D 4 or 5	49	0,10 0,29
9	1,5	W 3,25 D 4 or 5	60,5	0,10 0,38
10	2	W 3,25 D 4 or 5	77,5	0,10 0,51
11	2	W 3,25 D 4 or 5	92	0,10 0,62
12	2	W 3,25 D 4 or 5	108	0,10 0,75
13	2	W 3,25 D 4 or 5	123	0,10 0,87
14	2	W 3,25 D 4 or 5	142	0,10 1,02
15	2	W 4 D 5 or 6	161	0,12 1,14
16	2	W 4 D 5 or 6	180	0,12 1,30
17	2	W 4 D 5 or 6	201	0,12 1,46
18	2	W 4 D 5 or 6	223	0,12 1,72
19	2	W 4 D 5 or 6	246	0,12 1,81
20	2	W 4 D 5 or 6	271	0,12 2,01

**W: RootPass      D: Filler Pass**

Half of the seam weight is added in the case of welding of plates that are up to 5mm for root welding from underside. At least the weight of the root pass should be added for the plaies that are thicker than 5mm.

Hail of the plate thickness is taken in case of welding seam weight for double-V groove. Double of the required V-groove is taken and opposing welding of the root side is added to this.

## Weld Bead Weight in V butt welding in vertical position

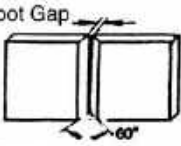
<b>V-Groove</b> Horizontal and flat position Groove angle: 60°				
				
Plate Thickness (mm)	Root Gap (mm)	Electrode Diameter (mm)	Approximate Seam Cross-Section (mm)	Seam Weight (kg/m)
3	1	2,5 or 3,25	8,5	0,09
4	1	3,25	13,5	0,14
5	1	3,25	19,5	0,20
6	1	3,25	27	0,26
7	1,5	3,25	39	0,36
8	1,5	3,25	49	0,45
9	1,5	W 3,25 D 4	60,5	0,20 0,34
10	2	W 3,25 D 4	77,5	0,20 0,47
11	2	W 3,25 D 4	92	0,20 0,59
12	2	W 3,25 D 4	108	0,20 0,73
13	2	W 3,25 D 4	123	0,20 0,85
14	2	W 3,25 D 4	142	0,20 1,00
15	2	W 3,25 D 4	161	0,20 1,14
16	2	W 3,25 D 4	180	0,20 1,30
17	2	W 3,25 D 4	201	0,20 1,47
18	2	W 3,25 D 4	223	0,20 1,73
19	2	W 3,25 D 4	246	0,20 1,83
20	2	W 3,25 D 4	271	0,20 2,01

**W: RootPass      D: Filler Pass**

Half of the seam weight is added in the case of welding of plates that are up to 8mm for root welding from underside. At least the weight of the root pass should be added for the plates that are thicker than 8mm.

Half of the plate thickness is taken in case of welding seam weight for double-V groove. Double of the required V-groove is taken and opposing welding of the root side is added to this.

## Weld Bead in V butt welding in overhead, vertical and horizontal vertical positions

**V-Groove** Overhead, vertical and horizontal vertical positions Groove angle: 70°

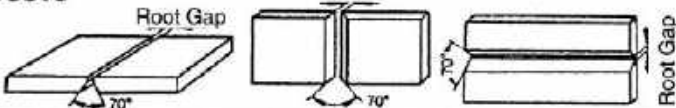

Plate Thickness (mm)	Root Gap (mm)	Electrode Diameter (mm)	Approximate Seam Cross-Section (mm)	Seam Weight (kg/m)
3	1	2,5	9,5	0,10
4	1	2,5 or 3,25	16	0,16
5	1	3,25	22,5	0,22
6	1	3,25	31	0,29
7	1,5	3,25	45	0,41
8	1,5	3,25	57	0,51
9	1,5	W 3,25 D 4	70,5	0,20 0,42
10	2	W 3,25 D 4	90,5	0,20 0,57
11	2	W 3,25 D 4	107	0,20 0,71
12	2	W 3,25 D 4	125,5	0,20 0,87
13	2	W 3,25 D 4	138	0,20 0,97
14	2	W 3,25 D 4	165	0,20 1,18
15	2	W 3,25 D 4	188	0,20 1,36
16	2	W 3,25 D 4	211	0,20 1,54
17	2	W 3,25 D 4	236	0,20 1,74
18	2	W 3,25 D 4	263	0,20 1,95
19	2	W 3,25 D 4	291	0,20 2,18
20	2	W 3,25 D 4	320	0,20 2,41

**W: RootPass      D: Filler Pass**

Half of the seam weight is added in the case of welding of plates that are up to 8mm for root welding from underside. At least the weight of the root pass should be added for the plates that are thicker than 8mm.

Half of the plate thickness is taken in case of welding seam weight for double-V groove. Double of the required V-groove is taken and opposing welding of the root side is added to this.

## Weld Bead Weight in fillet welding in horizontal and flat positions

<b>Fillet Welding</b>			
Horizontal and flat position			
Plate Thickness (mm)	Electrode Diameter (mm)	Approximate Seam Cross-Section (mm)	Seam Weight (kg/m)
2	2,5	4	0,038
2,5	2,5 or 3,25	6,5	0,058
3	3,25 or 4	9	0,082
3,5	3,25 or 4	12,5	0,115
4	3,25 or 4	16	0,15
4,5	3,25 or 4	20,5	0,18
5	3,25 or 4	25	0,23
5,5	3,25 or 4	30,5	0,28
6	3,25 or 4	36	0,33
6,5	3,25 or 4	42,5	0,39
7	3,25 or 4	49	0,45
7,5	3,25 or 4	56,5	0,52
8	W 4 D 5	64	0,18 0,41
8,5	W 4 D 5	72,5	0,18 0,48
9	W 4 D 5	81	0,18 0,56
9,5	W 4 D 5	90,5	0,18 0,65
10	W 4 D 5 or 6	100	0,18 0,73
11	W 4 D 5 or 6	121	0,18 0,92
12	W 4 D 5 or 6	144	0,18 1,14
13	W 4 D 5 or 6	169	0,18 1,37
14	W 4 D 5 or 6	196	0,18 1,60
15	W 4 D 5 or 6	225	0,18 1,89
16	W 4 D 5 or 6	256	0,18 2,14

**W: RootPass**
**D: Filler Pass**



## Weld Bead Weight in fillet welding in vertical position

<b>Fillet Welding</b>			
Vertical position			
Plate Thickness (mm)	Electrode Diameter (mm)	Approximate Seam Cross-Section (mm)	Seam Weight (kg/m)
2	2 or 2,5	4	0,040
2,5	2 or 2,5	6,5	0,061
3	2,5 or 3,25	9	0,086
3,5	3,25	12,5	0,12
4	3,25	16	0,16
4,5	3,25	20,5	0,19
5	W 3,25 D 4	25	0,10 0,14
5,5	W 3,25 D 4	30,5	0,10 0,19
6	W 3,25 D 4	36	0,10 0,25
6,5	W 3,25 D 4	42,5	0,10 0,31
7	W 3,25 D 4	49	0,10 0,37
7,5	4	56,5	0,55
8	4	64	0,62
8,5	4	72,5	0,69
9	4	81	0,78
9,5	4	90,5	0,87
10	4	100	0,96
11	4	121	1,16
12	4	144	1,39
13	4	169	1,63
14	4	196	1,87
15	4	225	2,17
16	4	256	2,44

**W: RootPass**
**D: Filler Pass**

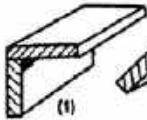

## Weld Bead Weight in fillet welding in overhead position

<b>Fillet Welding</b> <b>Overhead position</b>			
Generally, electrodes with 3,25 Ø are used for static circumstances in overhead position similar to the situation (1).  			
Plate Thickness (mm)	Electrode Diameter (mm)	Approximate Seam Cross-Section (mm)	Seam Weight (kg/m)
2	2,5	4	0,040
2,5	2,5	6,5	0,061
3	2,5	9	0,086
3,5	2,5	12,5	0,12
4	2,5	16	0,16
4,5	2,5	20,5	0,19
5	3,25	25	0,24
5,5	3,25	30,5	0,29
6	3,25	36	0,35
6,5	3,25	42,5	0,41
7	3,25	49	0,47
7,5	3,25	56,5	0,55
8	W 3,25 D 4	64	0,10 0,52
8,5	W 3,25 D 4	72,5	0,10 0,59
9	W 3,25 D 4	81	0,10 0,68
9,5	W 3,25 D 4	90,5	0,10 0,77
10	W 3,25 D 4	100	0,10 0,86
11	W 3,25 D 4	121	0,10 1,06
12	W 3,25 D 4	144	0,10 1,29
13	W 3,25 D 4	169	0,10 1,53
14	W 3,25 D 4	196	0,10 1,77
15	W 3,25 D 4	225	0,10 2,07
16	W 3,25 D 4	256	0,10 2,34

**W: RootPass**
**D: Filler Pass**

## Weld Bead Weight in 1-butt weld ng of thin plates in horizontal position

<b>I-Groove of Thin Plates</b>			
Plate Thickness (mm)	Root Gap (mm)	Electrode Diameter (mm)	Seam Weight of Convex Seams (kg/m)
1,5	0,5	2	0,015
2	1	2	0,030
2,5	1,2	2,5	0,060
3	1,5	2,5 (3,25)	0,075
3,5	1,5	3,25	0,090

### Labor Costs

Labor is not only the wage of the welder. It is one-hour labor cost that is calculated by adding wages of everybody that contributes to the application of that welding seam in a certain rate. This labor cost is divided to the one meter long welding seam. The following formula is used in calculation.

$$\text{Labor Costs/meter welding} = \frac{l_g \cdot KMA}{EG \cdot \eta_1} \quad (\text{TL/meter welding})$$

- $l_g$  : One hour cost (TL)
- $KMA$  : Weight of the one meter long welding metal (Kg)
- $EG$  : Melting power of electrodes (Kg/h)
- $\eta_1$  : Operation factor

## Number of electrodes for each Kg/m bead weight

(Efficiency is considered to be 90% and discarded stem length is considered to be 30mm)

Seam Weight (kg/m)	Electrode diameters and lengths									
	1,5 250	2 250	2,5 250	2,5 350	3,25 350	3,25 450	4 350	4 450	5 450	6 450
0,01	3,6	2,0	1,3	0,9	0,5	0,4	0,4	0,3	0,2	0,1
0,02	7,3	4,1	2,6	1,8	1,1	0,8	0,7	0,5	0,3	0,2
0,03	10,9	6,1	3,9	2,7	1,6	1,2	1,1	0,8	0,5	0,4
0,04	14,5	8,2	5,3	3,6	2,1	1,6	1,4	1,1	0,7	0,5
0,05	18,2	10,2	6,5	4,5	2,7	2,0	1,8	1,3	0,9	0,6
0,06	21,8	12,3	7,9	5,4	3,2	2,4	2,1	1,6	1,0	0,7
0,07	25,4	14,3	9,2	6,3	3,7	2,9	2,5	1,9	1,2	0,9
0,08	29,1	16,4	10,5	7,2	4,3	3,3	2,8	2,2	1,4	1,0
0,09	32,7	18,4	11,8	8,1	4,8	3,7	3,2	2,4	1,5	1,1
0,10	36,4	20,4	13,1	9,0	5,3	4,1	3,5	2,7	1,7	1,2
0,15	54,5	30,7	19,7	13,5	8,0	6,1	5,3	4,0	2,6	1,8
0,20	72,8	40,9	26,2	18,1	10,7	8,1	7,0	5,4	3,4	2,4
0,25	91,0	51,1	32,8	22,6	13,3	10,2	8,8	6,7	4,3	3,0
0,30	109	61,3	39,4	27,1	16,0	12,2	10,6	8,1	5,2	3,6
0,35	127	71,5	46,0	31,6	18,7	14,2	12,3	9,4	6,0	4,2
0,40	145	81,8	52,5	36,2	21,4	16,3	14,1	10,8	6,9	4,8
0,45	164	92,0	59,1	40,7	24,0	18,3	15,8	12,1	7,7	5,4
0,50	182	102	65,6	45,2	26,7	20,3	17,6	13,4	8,6	6,0
0,55	200	113	72,2	49,7	29,4	22,4	19,4	14,8	9,4	6,6
0,60	218	123	78,8	54,3	32,0	24,4	21,1	16,1	10,3	7,2
0,65	236	133	85,4	58,8	34,7	26,4	22,9	17,5	11,1	7,7
0,70	254	143	92,0	63,3	37,4	28,5	24,6	18,8	12,0	8,3
0,75	273	153	98,5	67,8	40,0	30,5	26,4	20,2	12,9	8,9
0,80	291	164	105	72,2	42,7	32,5	28,2	21,5	13,7	9,5
0,85	309	174	112	76,9	45,4	34,6	30,0	22,8	14,6	10,1
0,90	327	184	118	81,4	48,0	36,6	31,7	24,2	15,4	10,7
0,95	346	194	125	85,9	50,7	38,6	33,5	25,6	16,3	11,3
1,00	364	204	131	90,4	53,4	40,7	35,2	26,9	17,2	11,9
2,00	728	409	262	181	107	81,3	70,4	53,8	34,3	23,8
3,00	1090	613	394	271	160	122	106	80,7	51,5	35,7
4,00	1450	818	460	362	214	162	141	108	68,6	47,6
5,00	1820	1020	525	452	267	203	176	134	85,7	59,5
6,00	2180	1230	788	543	320	244	211	161	103	71,5
7,00	2540	1430	920	633	374	285	246	188	120	83,4
8,00	2910	1640	1050	723	427	325	288	215	137	95,3
9,00	3270	1840	1180	814	480	366	317	242	154	107
10,00	3640	2040	1310	904	534	407	352	269	172	119

## BRINELL, ROCKWELL, VICKERS HARDNESS COMPARISON TABLE

Impact Strength	Vickers Hardness	Brinell Hardness	Rockwell Hardness							
			HRB	HRF	HRC	HRA	HRD	HR 15 N	HR 30 N	HR 45 N
255	80	76.0	-	-	-	-	-	-	-	-
270	85	80.7	41.0	-	-	-	-	-	-	-
285	90	85.5	48.0	82.6	-	-	-	-	-	-
305	95	90.2	52.0	-	-	-	-	-	-	-
320	100	95.0	56.2	87.0	-	-	-	-	-	-
335	105	99.8	-	-	-	-	-	-	-	-
350	110	105	62.3	90.5	-	-	-	-	-	-
370	115	109	-	-	-	-	-	-	-	-
385	120	114	66.7	93.6	-	-	-	-	-	-
400	125	119	-	-	-	-	-	-	-	-
415	130	124	71.2	96.4	-	-	-	-	-	-
430	135	128	-	-	-	-	-	-	-	-
450	140	133	75.0	99.0	-	-	-	-	-	-
465	145	138	-	-	-	-	-	-	-	-
480	150	143	78.7	101.4	-	-	-	-	-	-
495	155	147	-	-	-	-	-	-	-	-
510	160	152	81.7	103.6	-	-	-	-	-	-
530	165	156	-	-	-	-	-	-	-	-
545	170	162	85.0	105.5	-	-	-	-	-	-
560	175	166	-	-	-	-	-	-	-	-
575	180	171	87.1	107.2	-	-	-	-	-	-
595	185	176	-	-	-	-	-	-	-	-
610	190	181	89.5	105.5	-	-	-	-	-	-
625	195	185	-	-	-	-	-	-	-	-
640	200	190	91.5	110.1	-	-	-	-	-	-
660	205	195	92.5	-	-	-	-	-	-	-
675	210	199	93.5	111.3	-	-	-	-	-	-
690	215	204	94.0	-	-	-	-	-	-	-
705	220	209	95.0	112.4	-	-	-	-	-	-
720	225	214	96.0	-	-	-	-	-	-	-
740	230	219	96.7	113.4	-	-	-	-	-	-
755	235	223	-	-	-	-	-	-	-	-
770	240	228	98.1	114.3	20.3	60.7	40.3	69.6	41.7	19.9
785	245	233	-	-	21.3	61.2	41.1	70.1	42.5	21.1
800	250	238	99.5	115.1	22.2	61.6	41.7	70.6	43.4	22.2
820	255	242	-	-	23.1	62.0	42.2	71.1	44.2	23.2
835	260	247	(101)	-	24.0	62.4	43.1	71.6	45.0	24.3
850	265	252	-	-	24.8	62.7	43.7	72.1	45.7	25.2
865	270	257	(102)	-	25.6	63.1	44.3	72.6	46.4	26.2
880	275	261	-	-	26.4	63.5	44.9	73.0	47.2	27.1
900	280	266	(104)	-	27.1	63.8	45.3	73.4	47.8	27.9
915	285	271	-	-	27.8	64.2	46.0	73.8	48.4	28.7
930	290	276	(105)	-	28.5	64.5	46.5	74.2	49.0	29.5
950	295	280	-	-	29.2	64.8	47.1	74.6	49.7	30.4
965	300	285	-	-	29.8	65.2	47.5	74.9	50.2	31.1
995	305	295	-	-	31.0	65.8	48.4	75.6	51.3	32.5
1030	310	304	-	-	32.2	66.4	49.4	76.2	52.3	33.9
1060	315	314	-	-	33.3	67.0	50.2	76.8	53.6	35.2
1095	320	323	-	-	34.4	67.6	51.1	77.4	54.4	36.5
1125	325	333	-	-	35.5	68.1	51.9	78.0	55.4	37.8

## BRINELL, ROCKWELL, VICKERS HARDNESS COMPARISON TABLE

Impact Strength	Vickers Hardness	Brinell Hardness	Rockwell Hardness								
			HRB	HRF	HRC	HRA	HRD	HR 15 N	HR 30 N	HR 45 N	
1155	360	342	-	-	36.6	68.7	52.8	78.6	56.4	39.1	
1190	370	352	-	-	37.7	69.2	53.6	79.2	57.4	40.4	
1220	380	361	-	-	38.8	69.8	54.4	79.8	58.4	41.7	
1255	390	371	-	-	39.8	70.3	55.3	80.3	59.3	42.9	
1290	400	380	-	-	40.8	70.8	56.0	80.8	60.2	44.1	
1320	410	390	-	-	41.8	71.4	56.8	81.4	61.1	45.3	
1350	420	399	-	-	42.7	71.8	57.5	81.8	61.9	46.4	
1385	430	409	-	-	43.6	72.3	58.2	82.3	62.7	47.4	
1420	440	418	-	-	44.5	72.8	58.8	82.8	63.5	48.4	
1455	450	428	-	-	45.3	73.3	59.4	83.2	64.3	49.4	
1485	460	437	-	-	46.1	73.6	60.1	83.6	64.9	50.4	
1520	470	447	-	-	46.9	74.1	60.7	83.9	65.7	51.3	
1555	480	(456)	-	-	47.7	74.5	61.3	84.3	66.4	52.2	
1595	490	(466)	-	-	48.4	74.9	61.6	84.7	67.1	53.1	
1630	500	(475)	-	-	49.1	75.3	62.2	85.0	67.7	53.9	
1665	510	(485)	-	-	49.8	75.7	62.9	85.4	68.8	58.6	
1700	520	(494)	-	-	50.5	76.1	63.5	85.7	69.0	55.6	
1740	530	(504)	-	-	51.1	76.4	63.9	86.0	69.5	56.2	
1775	540	(513)	-	-	51.7	76.7	64.4	86.3	70.0	57.0	
1810	550	(523)	-	-	52.3	77.0	64.8	86.6	70.5	57.8	
1845	560	(532)	-	-	53.0	77.4	65.4	86.9	71.2	58.6	
1880	570	(542)	-	-	53.6	77.8	65.8	87.2	71.7	59.3	
1920	580	(551)	-	-	54.1	78.0	66.2	87.5	72.1	59.9	
1955	590	(561)	-	-	54.7	78.4	66.7	87.8	72.7	60.5	
1995	600	(570)	-	-	55.2	78.6	67.0	88.0	73.2	61.2	
2030	610	(580)	-	-	55.7	78.9	67.5	88.2	73.7	61.7	
2070	620	(589)	-	-	56.3	79.2	67.9	88.5	74.2	62.4	
2105	630	(599)	-	-	56.8	79.5	68.3	88.8	74.6	63.0	
2145	640	(608)	-	-	57.3	79.8	68.7	89.0	75.1	63.5	
2180	650	(618)	-	-	57.8	80.0	69.0	89.2	75.5	64.1	
-	660	-	-	-	58.3	80.3	69.4	89.5	75.9	64.7	
-	670	-	-	-	58.8	80.6	69.8	89.7	76.4	65.3	
-	680	-	-	-	59.2	80.8	70.1	89.8	76.8	65.7	
-	690	-	-	-	59.7	81.1	70.5	90.1	77.2	66.2	
-	700	-	-	-	60.1	81.3	70.8	90.3	77.6	66.7	
-	720	-	-	-	61.0	81.8	71.5	90.7	78.4	67.7	
-	740	-	-	-	61.8	82.2	72.1	91.0	79.1	68.6	
-	760	-	-	-	62.5	82.6	72.6	91.2	79.7	69.4	
-	780	-	-	-	63.3	83.0	73.3	91.5	80.4	70.2	
-	800	-	-	-	64.0	83.4	73.8	91.8	81.1	71.0	
-	820	-	-	-	64.7	83.8	74.3	92.1	81.7	71.8	
-	840	-	-	-	65.3	84.1	74.8	92.3	82.2	72.2	
-	860	-	-	-	65.9	84.4	75.3	92.5	82.7	73.1	
-	880	-	-	-	66.4	84.7	75.7	92.7	83.1	73.6	
-	900	-	-	-	67.0	85.0	76.1	92.9	83.6	74.2	
-	920	-	-	-	67.5	85.3	76.5	93.0	84.0	74.8	
-	940	-	-	-	68.0	85.6	76.9	93.2	84.4	75.4	

## DRYING TEMPERATURES AND DURATIONS OF GEKA ELECTRODES

Standard	Material to which the electrode is applied	Coating Type	Drying Process (1-2)	Drying Temperature (2) °C	Drying Duration (3) (hour)
EN 499 DIN 1913  AWS 5.1	Unalloyed and low-alloy steels	A, AR, C R (C), R, RR RR (B)	not required	-	-
		B (R), B	required	300 - 350	2 - 10
EN 757 DIN 8529  AWS 5.5	High-strength fine-grained structural steels	B	required	300 - 350	2 - 10
EN 1599 DIN 8575  AWS 5.5	Heat resisting steels	R	not required	-	-
		B	required	300 - 350	2 - 10
EN 1600 DIN 8556  AWS 5.4	Stainless Heat resisting steels	R	recommended	100 - 200	2 - 10
		B (R), B	not required	-	-
	Mild Martensitic Steels	B	required	300 - 350	2 - 10
	Double phase Steels	(R) B	required	250 - 350	2 - 10
EN 14700 DIN 8555  AWS 5.13	hardfacing	R	not required	-	-
		B (R), B	required	300 - 350	2 - 10
		special	on producer's recommendation		
TS EN 14700 DIN 1736 AWS 5.11	nickel based alloys	all types	when necessary	120 - 300	2 - 10

- Electrodes in special can packages can be used without a drying process in 8 hours after the can is opened. In establishments that are more than 70% humid, electrodes should be put into special hot boxes at 100-200 °C after the package is opened.
- Please follow the recommendations of the producer for special circumstances.
- The maximum value is the sum of the durations of drying processes when electrode is dried multiple times (in different dates)

## CALCULATION OF WELDING CABLE CROSS-SECTION

In calculation of the welding cable cross-sections, the following empirical formula is used:

$$K = \frac{2 \times L \times I}{a \times U}$$

K: Cross-section of the appropriate cable (mm<sup>2</sup>).  
 L: Length of the bar (electrode) or the earth wire (m).  
 I: Strength of welding current (A).  
 U: Permitted voltage loss in the welding circuit (V).  
 (This value should not exceed 2V.)  
 a: parameter in relation to the material of the cable











For copper: a=60  
 For aluminum a=30  
 For zinc a=15  
 For iron a=8

Example: what should be the cross-section of the appropriate copper cable if the length of the cable is 15m in a welding process that is performed with 180A?

$$K = \frac{2 \times 15 \times 180}{60 \times 2} = 40 \text{ mm}^2$$

### Copper cable cross-sections depending on welding cable length and welding current

Welding Current (A)	Welding Current Length (m)				
	10	15	20	25	30
50	25	25	35	35	35
100	25	35	35	50	50
150	35	35	50	70	95
200	35	50	70	95	120
250	50	70	95	120	150
300	70	95	120	150	150

 <b>Gedik Welding</b>	 <b>Gedik Casting and Valve</b>	 <b>Gedik Education Foundation</b>	 <b>Gedik Test Center</b>	 <b>GEDİK University</b>
				
Ankara Cad. No: 306 Şeyhli 34906 İstanbul / Turkey T +90 216 378 50 00 F +90 216 378 20 44 <a href="http://www.gedikwelding.com">www.gedikwelding.com</a>	Ankara Caddesi No: 306 Şeyhli 34906 İstanbul / Turkey T +90 216 307 12 62 F +90 216 307 28 68-69  <b>Factory</b> Sakarya 2.OSB 11 No'lu Yol No: 6 54300 Hendek Sakarya/ Türkiye T +90 264 290 12 00 F +90 264 290 12 21 <a href="http://www.gedikcastingandvalve.com">www.gedikcastingandvalve.com</a>	Ankara Caddesi No: 306 C Blok Şeyhli 34906 İstanbul / Turkey T +90 216 378 50 00 F +90 216 378 20 44 <a href="http://www.gedikegitimvakfi.org.tr">www.gedikegitimvakfi.org.tr</a>	Ankara Cad. No: 306 Şeyhli 34906 İstanbul / Turkey T +90 216 378 79 41 F +90 216 378 20 44 <a href="http://www.gediktest.com">www.gediktest.com</a>	Cumhuriyet Mahallesi, İlkbahar Sk. No: 1-3-5 34876 Yakacak / Kartal İstanbul/ Turkey T +90 216 452 45 85 444 5 438 F +90 216 452 87 17 <a href="http://www.gedik.edu.tr">www.gedik.edu.tr</a>